



LEGGI E CONSERVA QUESTE ISTRUZIONI
 READ AND SAVE THESE INSTRUCTIONS
 READ CAREFULLY IN THE TEXT!

Dimensions (mm)

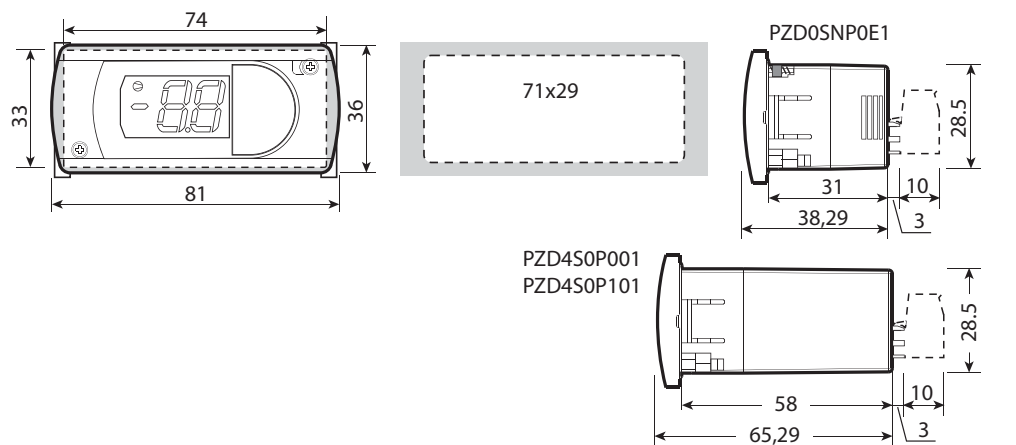

Fig.1

Panel mounting

Front (with 2 screws ø 2,5x12 mm)

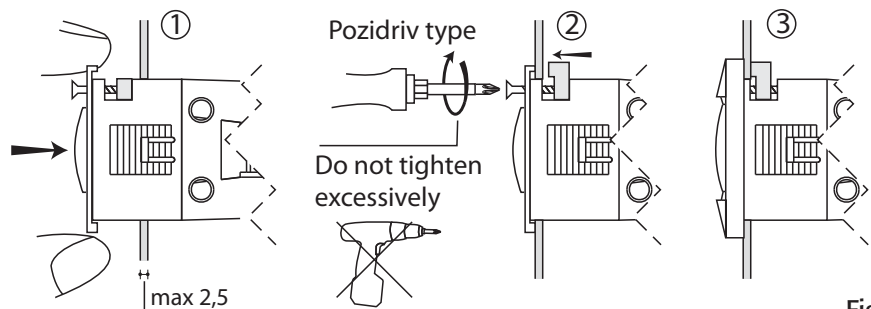

Fig.2

Rear (with 2 quick-fit side brackets)

If necessary, remove the covers to simplify wiring

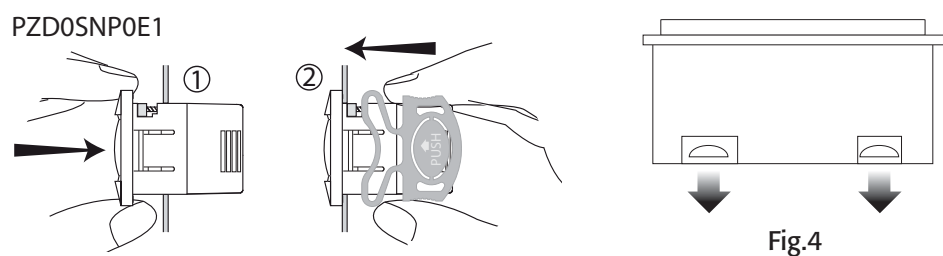

Fig.4

PZD450P001, PZD450P101

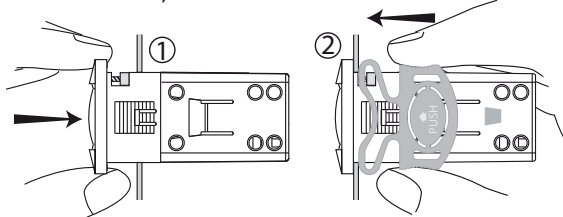
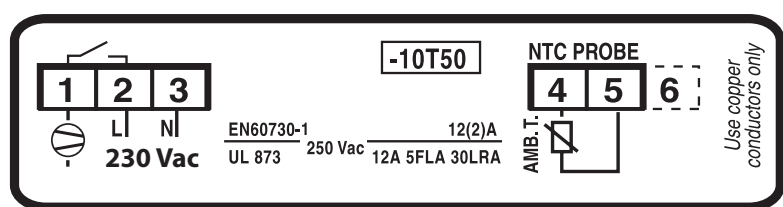

Fig.3

Electrical connections

PZD05NP0E1



PZD450P001

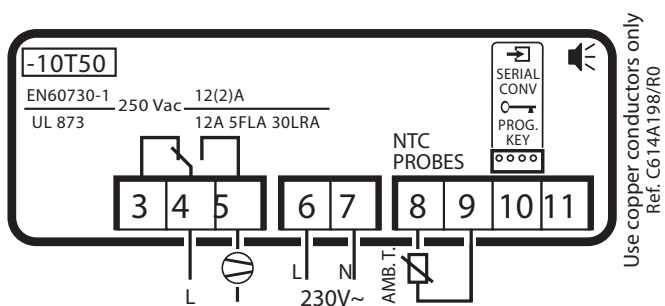

PZD450P101

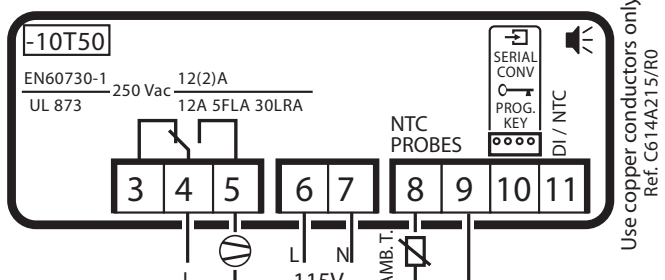

Fig.5

Description

PJEZ* represents a range of electronic microprocessor controllers with LED display developed for the management of refrigerating units, display cabinets and showcases; are designed for the management of static refrigerating units (no fan on the evaporator) operating at temperatures above 0°C.

Technical specifications

- Electronic controllers for normal temperature static refrigeration units
- Power supply 115Vac or 230Vac
- Ambient probe NTC
- Compressor relay 16A

Display and functions

During normal operation, the controller displays the value of the temperature read by probe. In addition, the display has LED that indicate the activation of the control functions (see Tab. 1), while the 3 buttons can be used to activate/deactivate some of the functions (see Tab. 2).

Compressor LED signals

| icon | function | normal operation | | | start up |
|------|-------------------|------------------|-----|------------------------|----------|
| | | ON | OFF | blink | |
| | compressor status | on | off | ON request in progress | ON |

Tab. 1

Table of functions activated by the buttons

| button | normal operation | start up |
|--------|---|-------------------------------------|
| | | |
| | more than 3 s: toggle ON/OFF | - |
| | more than 3 s: start/stop defrost | for 1 s display firmware vers. code |
| | - 1 s.: display/set the set point - more than 3 s: access parameter setting menu (enter password '22') | for 1 s RESET current EY set |

Tab. 2

Setting the setpoint (desired temperature)

| Step | Action | Effect | Meaning |
|------|---------------------------------|--|---|
| 1 | Keep SET button pressed for 2 s | After 1 sec currently setpoint value will flash on display | It's regulation setpoint currently active |
| 2 | Press UP or DOWN buttons | Setpoint value will change | Set desired value |
| 3 | Press SET button | Controller will visualize temperature read by probes again | setpoint is modified and saved |

Tab. 3

Accessing and setting the parameters

| Step | Action | Effect | Meaning |
|------|---|---|---|
| 1 | Keep SET button pressed for 3 s | After 3 s display will visualize "PS" | Password is requested |
| 2 | Press SET button again | Display will visualize "0" blinking | |
| 3 | Press UP or DOWN button | Visualized value on display will change | Insert password "22" |
| 4 | Press SET button | After 5 s the first parameter, "/5", will be visualized on display | It's the name of the first parameter |
| 5 | Press UP or DOWN button | Parameter list will be scrolled on display (refer to Table of parameters) | Select desired parameter |
| 6 | Press SET button | Display will visualize value of the selected parameter | It's the currently parameter value |
| 7 | Press UP or DOWN button | Parameter value visualized on display will change | Set desired value |
| 8 | Press SET button | Display will visualize parameter name again | Attention: parameters updating is not yet active |
| 9 | Repeat steps 5, 6, 7 and 8 for all desired parameters | | |
| 10 | Keep SET button pressed for 5 s | Controller will visualize temperature read by probes again | Attention: now parameters updating will be active |

Tab. 4

Table of parameters

| | Parameter | Min. | Max. | Def. | UOM |
|-----|--|-------|-------|------|-------|
| PS | PASSWORD | 0 | 99 | 22 | - |
| / | PROBE PARAMETERS | | | | |
| /5 | Select °C / °F (0 = °C; 1 = °F) | 0 | 1 | 0 | - |
| /6 | Disable decimal point (1 = disabled) | 0 | 1 | 0 | - |
| /C1 | Probe calibration (OFFSET) | -50.0 | 50.0 | 0.0 | °C/°F |
| r | CONTROL PARAMETERS | | | | |
| St | Setpoint (control temperature) | -50.0 | 90.0 | 3.0 | °C/°F |
| rd | Control differential (hysteresis) | 0.0 | 19.0 | 2.0 | °C/°F |
| c | COMPRESSOR PARAMETERS | | | | |
| c0 | Comp. and fan start delay after start-up | 0 | 100 | 0 | min |
| c1 | Min. time between successive comp. starts | 0 | 100 | 1 | min |
| c4 | Compressor safety (duty setting) | 0 | 100 | 15 | min |
| d | DEFROST PARAMETERS | | | | |
| d0 | Type of defrost (0 and 1= defrost by temperature; 2, 3 and 4= defrost by time) | 0 | 4 | 2 | - |
| d1 | Interval between defrosts | 0 | 199 | 6 | h/min |
| dP | Max. or effective defrost duration | 1 | 199 | 20 | min/s |
| d4 | Defrost when the instrument is switched on (1= activated) | 0 | 1 | 0 | - |
| d6 | Disable temperature display during defrost (1= display disabled) | 0 | 1 | 1 | - |
| A | ALARM PARAMETERS | | | | |
| A0 | Alarm differential | -20.0 | 20.0 | -2.0 | °C/°F |
| AL | Low temperature alarm threshold/deviation | -50.0 | 250.0 | -5.0 | °C/°F |
| AH | High temperature alarm threshold/deviation | -50.0 | 250.0 | 15.0 | °C/°F |
| Ad | Low and high temperature alarm delay | 0 | 199 | 0 | min |
| H | OTHER SETTINGS | | | | |
| H2 | Enable keypad 0= keypad disabled 1= keypad enabled 2= keypad enabled except for ON/OFF function | 0 | 2 | 1 | - |
| EY | Restore the Default settings | 0 | 1 | 0 | - |

Tab. 5

Table of alarms

| Alarm code | Description | Parameters involved |
|------------|----------------------------|---------------------|
| E0 | probe 1 error= control | - |
| LO | low temperature alarm | [AL] [Ad] |
| HI | high temperature alarm | [AH] [Ad] |
| EE | unit parameter error | - |
| EF | operating parameter error | - |
| dF | defrost running | [d6=0] |
| Pd | defrost awaiting execution | - |

Tab. 6

How to restore the Default settings (refer to table of parameters in this sheet)

- 1) Access parameter EY (entering password 22 and scroll parameter list).
- 2) Select the desired configuration:
 - EY = 0 → No changes;
 - EY = 1 → Restore of default settings (refer to Table of parameters in this sheet);
- 3) Exit the setting procedure (holding SET button for more than 3 s).
- 4) Power off the device and then power it on again while holding SET button.
- 5) The display shows "CE" to indicate that the configuration has been restored.

Switching the device ON/OFF

Press UP for more than 3 s. The control and defrost algorithms are now disabled and the instrument displays the message "OFF" alternating with the temperature read by the set probe.

Manual defrost

Press DOWN for more than 3 s (the defrost starts only if the temperature conditions are valid).

Continuous cycle

Press UP and DOWN together for more than 3 s.



WARNING: separate as much as possible the probe and digital input signal cables from the cables carrying inductive loads and power cables to avoid possible electromagnetic disturbance. Never run power cables (including the electrical panel wiring) and signal cables in the same conduits.

Technical specifications

| | |
|--|---|
| power supply | 115 Vac +10 / -15% 50/60 Hz 230 Vac -10% +15% 50/60 Hz |
| rated power | 3 W |
| input | NTC probe |
| relay output | 16 A relay UL: 12 A resistive 5 FLA, 30 LRA 240 Vac 30,000 cycles EN60730-1: 12(2)A or 10(4)A (N.O. only) 250 Vac 100000 cycles; |
| type of probe | Std CAREL NTC 10 KΩ at 25 °C |
| power supply/ relay output connector | - screw terminals pitch 5mm for cables with cross-sect. from 0.5 mm ² to 1.5 mm ² ; 12 A max; |
| probe connector | screw terminals: - 2-pin pitch 5mm for models with 1 probe (cable cross-section from 0.5 mm ² to 1.5 mm ²); 12 A max; |
| assembly | using screws from the front or with brackets at the rear |
| display | LED display, 2 digits plus sign, decimal point and compressor icon |
| keypad | 3 buttons with membrane |
| operating conditions | -10T50 °C - humidity <90% rH non-condensing |
| storage conditions | -20T70 °C - humidity <90% rH non-condensing |
| range of measurement | -50T90 °C (-58T194 °F) - resolution 0.1 °C/°F |
| front panel index of protection | panel installation with IP65 type 1 |
| case | plastic terminal, 81x36x38 mm |
| classification according to protection against electric shock | Class II |
| environmental pollution | II |
| PTI of the insulating material | 250 V |
| period of stress across the insulating parts | long |
| category of resistance to heat and fire | category D (UL94 - V0) |
| immunity against voltage surges | category 1 |
| type of action and disconnection | micro-disconnection 1C |
| no. of relay automatic operating cycles | EN60730-1: 100,000 cycles UL: 30,000 cycles (250 Vac) |
| software class and structure | Class A |
| cleaning the instrument | Only use neutral detergents and water |
| cable max. length | serial: 1 km probes: 30 m relay: 10 m |

Tab. 7

Note: do not run the power cable less than 3 cm from the bottom part of the device or from the probes; **for the connections only use copper wires.**

Safety standards

compliant with the relevant European standards. Installation precautions:

- the connection cables must guarantee insulation up to 90 °C;
- ensure a space of at least 10 mm between the case and the nearby conductive parts;
- digital and analogue input connections less than 30 m away; adopt suitable measures for separating the cables so as to ensure compliance with the immunity standards;

Secure the connection cables of the outputs so as to avoid contact with very low voltage parts.

IMPORTANT WARNINGS

The CAREL product is a state-of-the-art device, whose operation is specified in the technical documentation supplied with the product or can be downloaded, even prior to purchase, from the website www.carel.com. The customer (manufacturer, developer or installer of the final equipment) accepts all liability and risk relating to the configuration of the product in order to reach the expected results in relation to the specific final installation and/or equipment. The failure to complete such phase, which is required/indicated in the user manual, may cause the final product to malfunction; CAREL accepts no liability in such cases. The customer must use the product only in the manner described in the documentation relating to the product. The liability of CAREL in relation to its products is specified in the CAREL general contract conditions, available on the website www.carel.com and/or by specific agreements with customers.



Disposal of the product

The appliance (or the product) must be disposed of separately in accordance with the local waste disposal legislation in force.

CAREL reserves the right to modify the features of its products without prior notice.

CAREL

CAREL INDUSTRIES HQs

Via dell'Industria, 11 - 35020 Brugine - Padova (Italy)

Tel. (+39) 0499716611 - Fax (+39) 0499716600 - <http://www.carel.com> - e-mail: carel@carel.com

+050004121 - rel. 1.1 - 28.07.2011