



Danfoss Bluetooth® Gateway with Tool4Cool® LabEdition



Contents

1. Introduction	
1.1 General description	4
1.2 Important to know.....	4
1.3 Contents of the package.....	4
2. Starting and charging the gateway	
2.1 View of Danfoss Bluetooth® Gateway	5
2.2 Switching on	5
2.3 Charging the battery.....	6
2.4 Recommendations.....	6
3. Pairing the gateway	
3.1 Windows XP	7
3.2 Windows Vista	10
4. Configuring Tool4Cool®	14
5. Technical data overview	17
6. Gateway status	18
7. Safety notes	19
8. Troubleshooting	
8.1 Error message	20
8.2 LED2 is flashing red.....	20
8.3 Top causes of errors	20
8.4 There is no connection between the computer and the device served by the gateway	21

1. Introduction

1.1 General description

The Danfoss Bluetooth® gateway is used in the connection between a controller and a computer when running Tool4Cool® software.

The gateway is equipped with a high-performance rechargeable battery, so an external power source is not required. This makes the gateway particularly suitable in mobile applications.

Under normal circumstances no driver installation is required and the gateway functions fully independently of the operating system platform in use. However if problems arise, please refer to section 8.

Please read the instructions in this handbook before using the gateway for the first time.

1.2 Important to know

1. The Bluetooth® gateway is battery driven. It is not fully charged upon new delivery. Charging the gateway may take up to 2 hours. The gateway may be used while charging.
2. When fully charged the gateway will run continuously 8 – 12 hours without power supply.
3. The maximum range is ~10 meters.
4. The Bluetooth® gateway may be permanently installed in an application. In permanent applications the charger enclosed upon delivery is used as a power supply.
5. If no serial communication occurs over a period of 60 seconds then the Bluetooth® gateway will shut down to conserve the battery. If the finding and pairing of the Bluetooth® device takes more than 60 seconds then the gateway will shut down. In the event that the gateway shuts down in the middle of an operation simply turn it on again and repeat the operation.
6. Requirements for Bluetooth® adapters:
 - PC or adapter has to be a class 1 or class 2 Bluetooth® transmitter. The Danfoss Bluetooth® gateway is a class 2 transmitter.
 - Dedicated software has to support Bluetooth® serial ports.

1.3 Contents of the package

Bluetooth® RS485 gateway with male DSUB-9 plug connector
USB power supply
Operating Instructions

2. Starting and charging the gateway

2.1 View of Danfoss Bluetooth® Gateway



2.2 Switching on

To switch on the gateway:

1. Plug the Danfoss Bluetooth® gateway into the RS485 communication interface of the controller.
2. Switch on the Danfoss Bluetooth® gateway.
3. The gateway enters operating mode. LED2 flashes green rapidly for approx. 3 seconds and then slowly green. (For LED sequences, please see the overview in section 6.)

2.3 Charging the battery

The Danfoss Bluetooth® gateway is equipped with a high-performance rechargeable battery, so an external power source is not required. This makes the gateway particularly suitable in mobile applications.

We recommend charging the battery before using the device for the first time.

To avoid overcharging and faulty operation, always use the battery charger supplied with the gateway.

The time required for full charging is approximately 2 hours.

To charge the battery:

1. Connect the charger to the USB port at the rear of the Bluetooth® gateway
2. Then connect the charger to the wall socket.
3. The status of the charging process is indicated by LED1 ("Charging") on the gateway, as follows:

Battery status, during charging with the USB power supply:

LED1	Meaning
<i>RED</i>	Battery is charging - charge duration to full capacity for empty battery approx. 2 hours
<i>OFF</i>	RS485 Danfoss Bluetooth® gateway is not connected to the charger or the battery is fully charged.

2.4 Recommendations

1. Keep the gateway fully charged, so it is ready for field work.
2. Keep an USB-cable/charger as a backup in the car just for the case someone forgets to charge the gateway battery

3. Pairing the gateway

In order to communicate, Bluetooth® devices must first be paired. Pairing is performed before using the device for the first time. Pairing does not need to be repeated for subsequent use.

Please choose the operating system installed on your computer.

3.1 Windows XP

1. Attach or turn on the Bluetooth® radio adapter (transceiver) for your Windows XP computer.
2. Turn on the Danfoss Bluetooth® gateway by pressing briefly on the push button. The LED will blink green.

Please note!

The gateway runs for 60 seconds before shutting down automatically.

At each step of the pairing process, check that the LED is still blinking.

If one stage of the pairing fails, turn the gateway on again, and try again.

3. Open Bluetooth® Devices in Control Panel/Printers and Other Hardware (Category view) or Control Panel (Classic view).

Control Panel Category View:

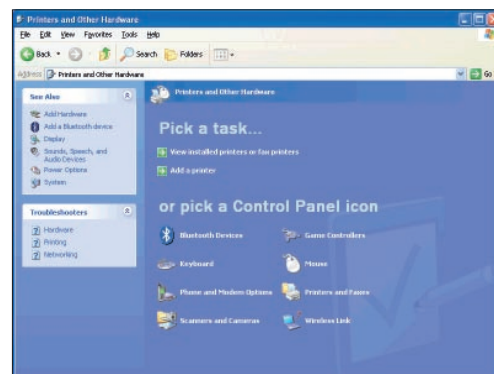
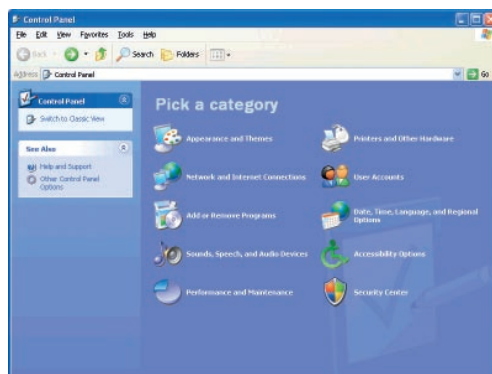

Control Panel Classic View:

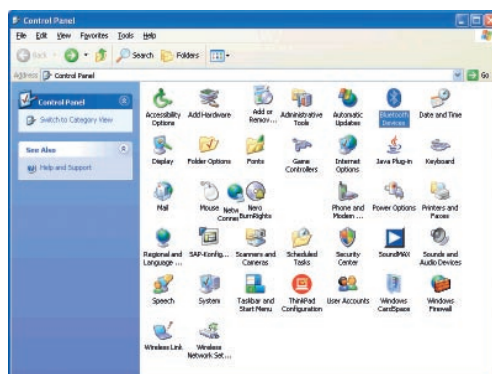

4. On the *Devices* tab, click *Add*.

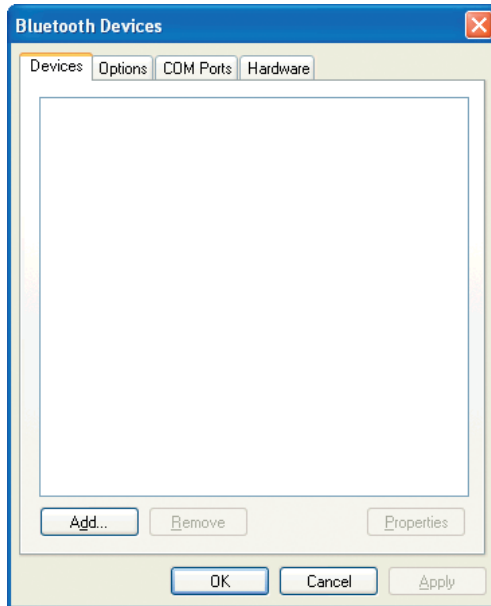

5. Select the *My device is set up and ready to be found* check box, and then click *Next*.



6. Click on the Danfoss Bluetooth® gateway shown in the dialog, and then click *Next*.

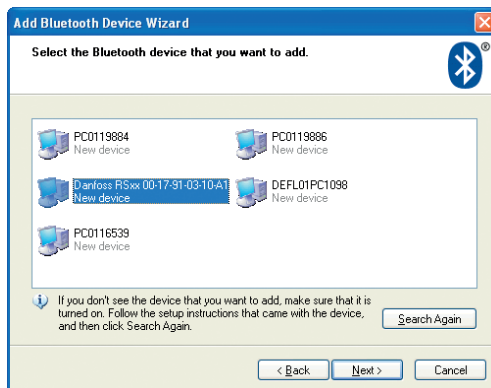

7. Click *Use the passkey found in the documentation*, and then type the passkey: 1234.

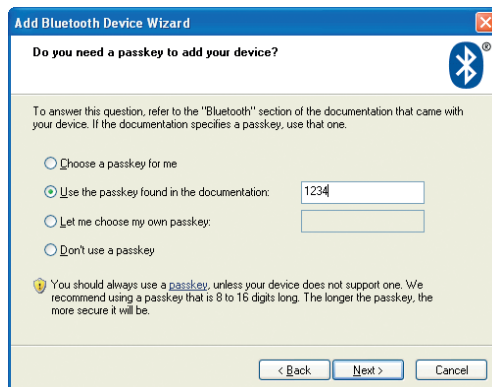

8. Note the outgoing COM port, in this example COM 9. Then click *Finish* to complete pairing.



9. The COM port can also be viewed in the COM ports tab of the Bluetooth® devices dialog. Make a note of the Outgoing COM port (in this example, COM9):

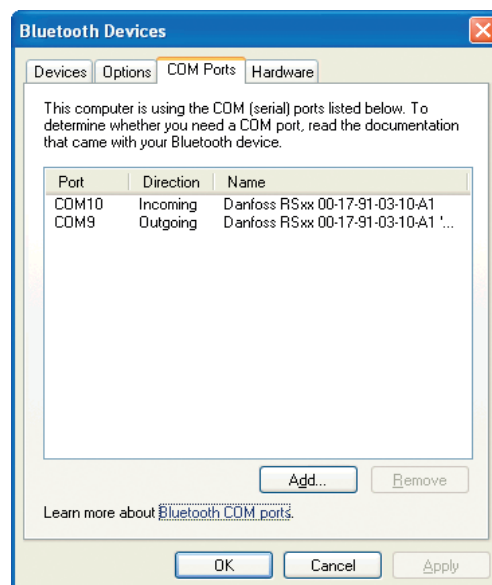
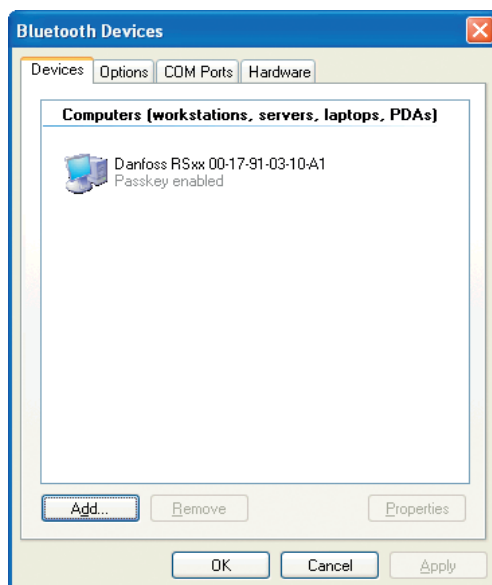

3.2 Windows Vista

1. Attach or turn on the Bluetooth® radio adapter (transceiver) for your Windows Vista computer.
2. Turn the Danfoss Bluetooth® gateway on by pressing briefly on the push button. The LED will blink green.

Please note!:

The gateway runs for 60 seconds before shutting down automatically.

At each step of the pairing process, check that the LED is still blinking .

If one stage of the pairing fails, turn the gateway on again, and try again.

3. Open Bluetooth® Devices in Control Panel/Hardware and Sound.

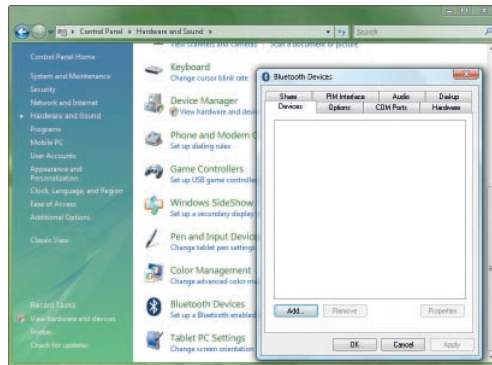

4. Select *Add* then *OK*. The wizard will open:



5. Check the Bluetooth® gateway is turned on. Click the box *My device is set up and ready to be found*. Select *Next*. The wizard will search...

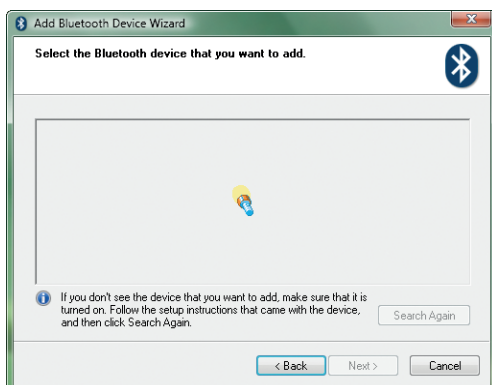

...and then display nearby Bluetooth® devices:

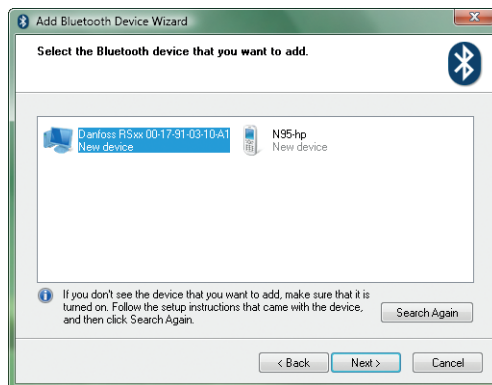

6. Select the *Danfoss device*, then select *Next*.

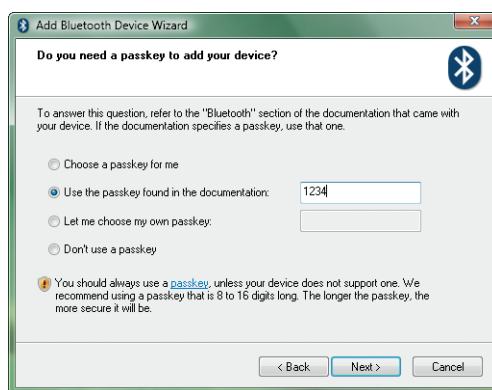

7. Enter the passkey 1234 as shown, then select *Next*.
The wizard will perform these steps:

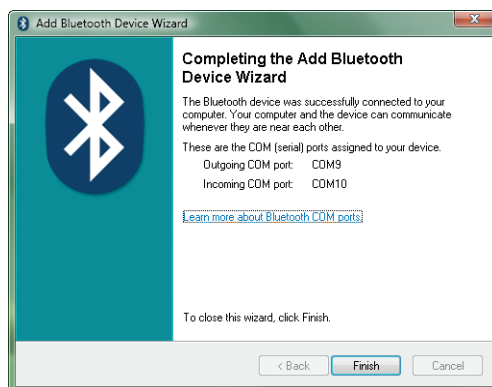
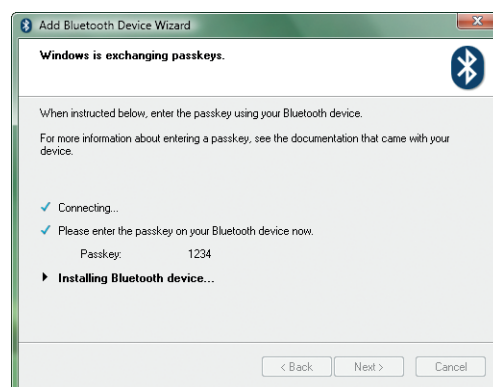
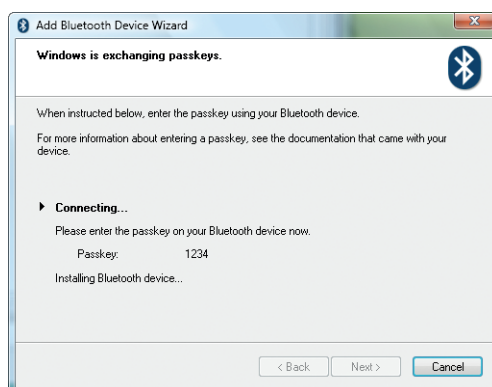

8. Select *Finish* to complete pairing.

Now look at the Control Panel again, to confirm the Danfoss device is visible:

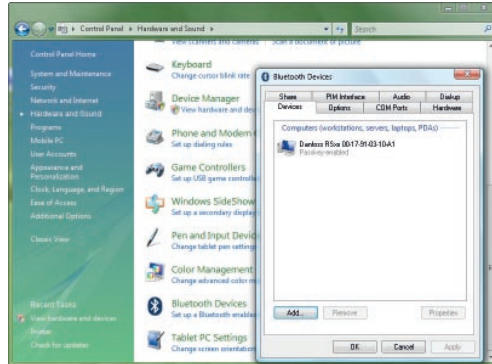

9. Select the *Danfoss device*, then select *Properties* as shown here:

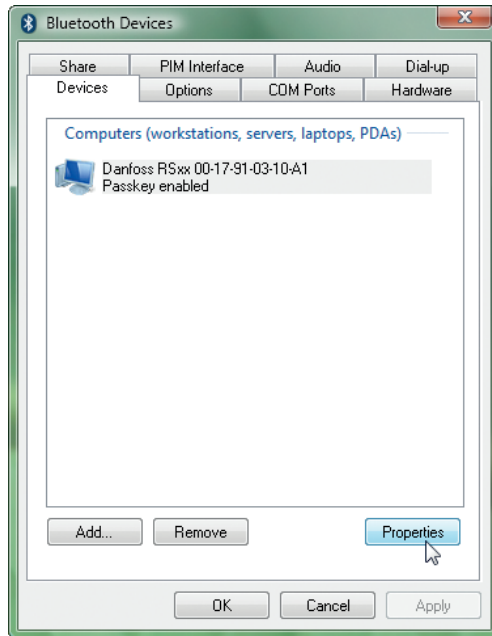

- Under the *Services* tab, make a note of the COM port to which the gateway is paired.
In this example it is COM9:

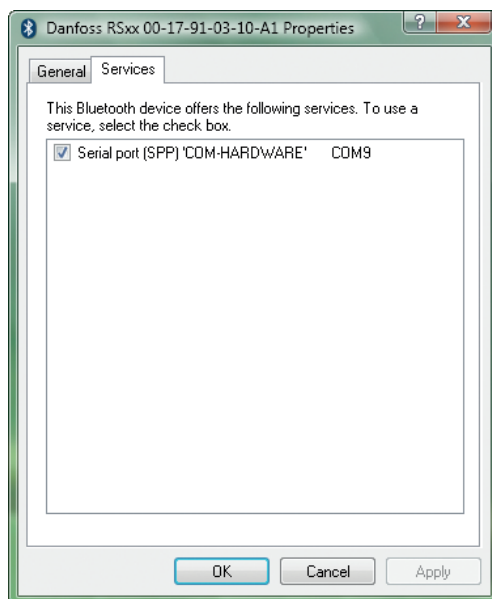

Alternatively, the COM port can be viewed in the COM ports tab of the Bluetooth® devices dialog. Make a note of the Outgoing COM port:

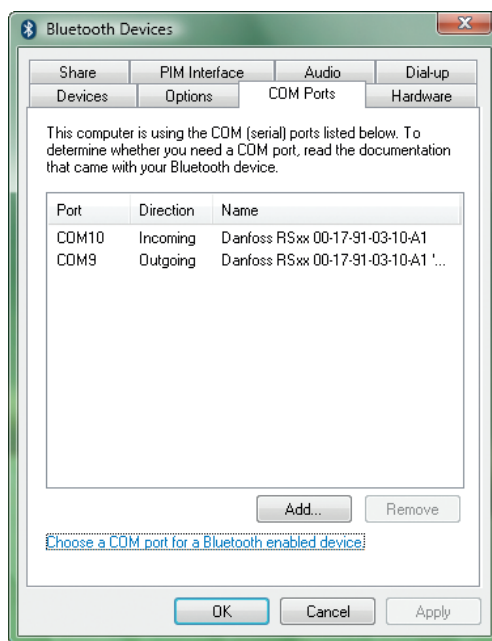

4. Configuring Tool4Cool®

1. Start Tool4Cool®
2. Select *File* in the menu bar.
3. Select *Connect Network* in the drop-down menu:

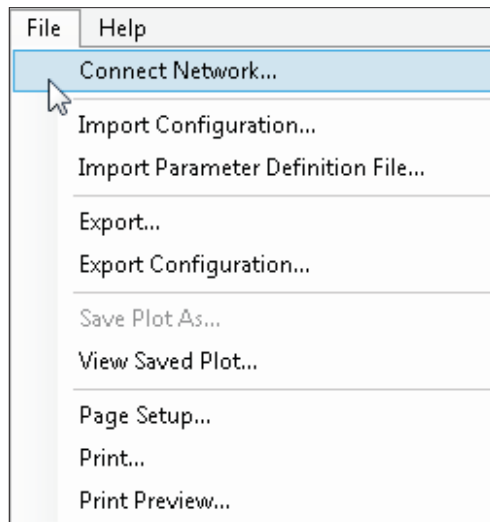

3. This dialog box will open:

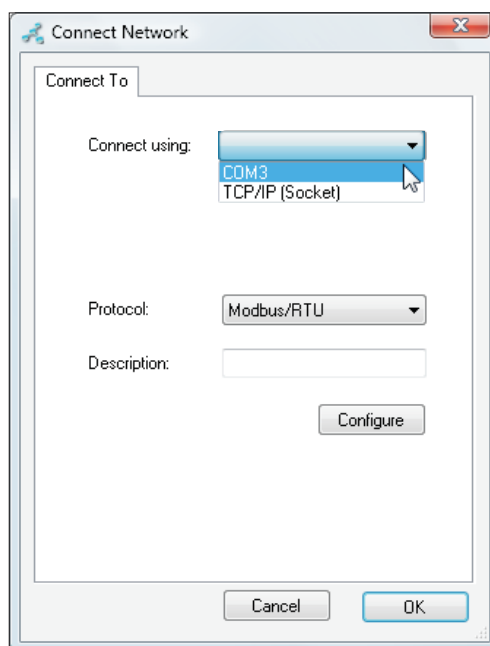

In the *Connect using field*, select the COM port to which the gateway is connected.
 Note!: This is the COM port you noted down in section 3. *Pairing the gateway*.
 Fill in *Description* (optional).

4. Click on the Configure button:

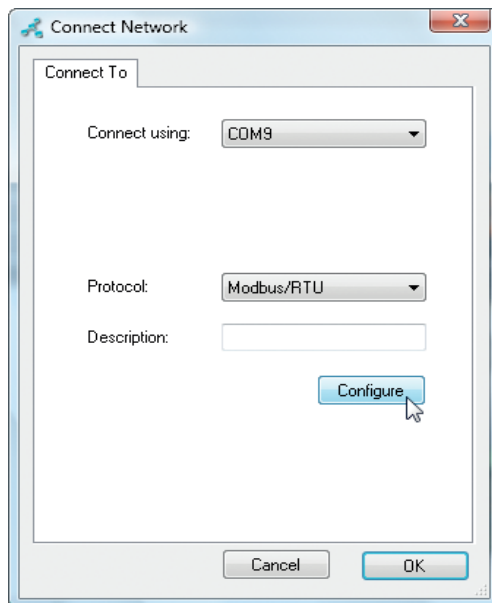

5. The *Configure Network* dialog box will appear.

6. Set the *Refresh rate* to ~5 times the number of addressable nodes,
 $5 \times [(Last\ network\ node + 1) - First\ network\ node]$

This ensures that Tool4Cool® will prevent the Bluetooth® gateway from timing out and turning the power off. Tool4Cool® scans the network and detects changes.

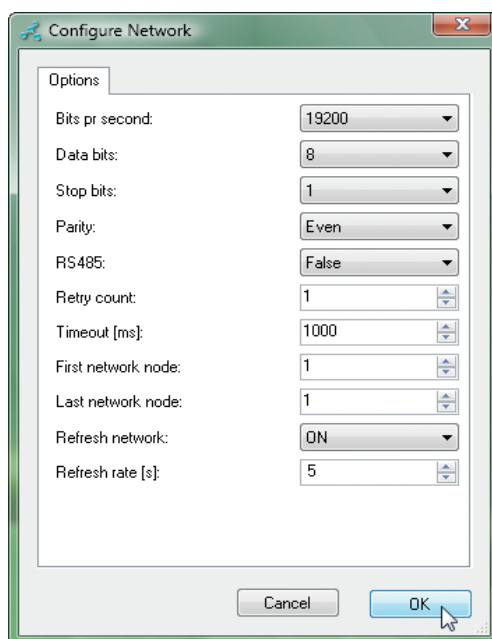

Then press *OK* to return to the *Connect Network* dialog.

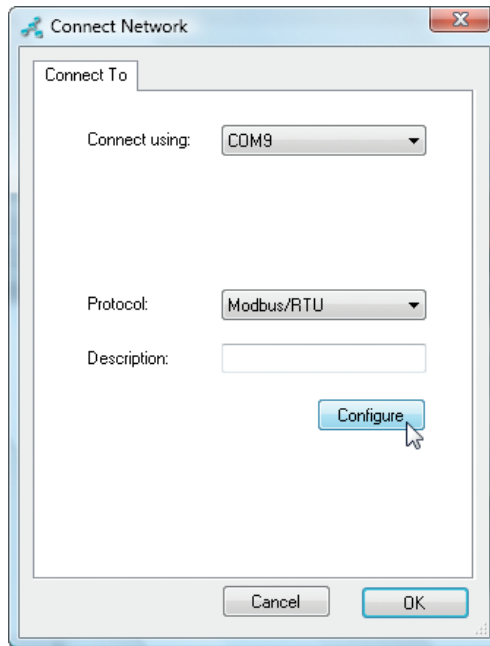

7. Check the gateway is turned on.

In the *Connect Network* dialog, press *OK*.

Wait a short time. A red arrow will appear in front of the description (COM/USB network).

The controller is now accessible via Tool4Cool®.

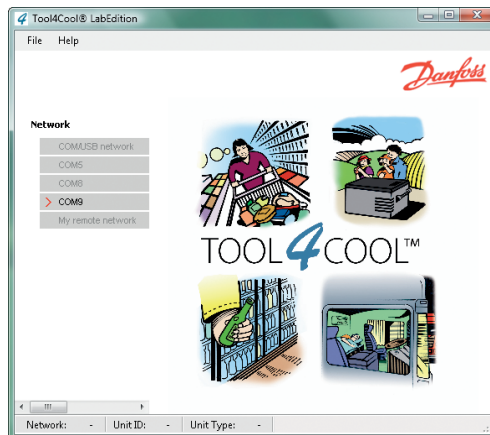





5. Technical data overview

Transmission frequencies		2.402 GHz to 2.480 GHz
Range		max. 10 m
Bluetooth® Interface		Generic Access Profile
Supported Bluetooth® profiles		Serial Port Profile
Transmission power		(Class 2) max. 4dBm
Serial interface	Connector	RS485 with male DSUB-9 plug connector
USB interface		Mini USB port 2.0 for charging and power supply
Battery	Type	Lithium-Ion rechargeable battery, 3.7V/540mAh
	Operating time	Maximum 10 hours (115.2 kBit/s), fully charged
	Charging time	Maximum 2 h
DC interface		DC power jack 0.65 mm, 6 - 24 V DC stabilized
LED1		Status display for battery
LED2		Status display for gateway
Casing		ABS translucent blue, dimensions 80x40x18 mm
Standard configuration	Baud rate	19200 Bit/s
	Stop bit	1
	Parity	Even
	Data bits	8
	Bluetooth® PIN	1234
Weight including antenna and battery		62 grams
Operating temperature		-20 to +60°C
Charging temperature		0 to +45 °C
Storage temperature		-20 to +45°C

6. Gateway status

The Danfoss Bluetooth® gateway operates as a gateway between a controller and a computer. LED2 ("Status") indicates the operating status of the gateway.

LED2 Sequence	Meaning
<p><i>LED flashes green for approx. 3 seconds in short, rapid bursts</i></p> 	RS485 Bluetooth® gateway begins Slave mode operation
<p><i>LED flashes green in slow, short bursts</i></p> 	RS485 Bluetooth® gateway is in normal operating mode – RS485 COM-HARDWARE service is active. Incoming connections are accepted.
<p><i>LED alternates rapidly between red and green</i></p> 	RS485 Bluetooth® gateway is in normal operating mode – RS485 COM-HARDWARE service is active. A connection between PC and gateway has been successfully established (Tool4Cool® is running).
<p><i>LED flashes green for approx. 3 seconds in short, rapid bursts followed by slow short bursts</i></p> 	RS485 Bluetooth® gateway is in manual operation mode – RS485 COM-HARDWARE service is not active. (Tool4Cool® is not running) or wrong communication setup (e.g. pairing).

7. Safety notes

7.1 Conformity with standards

This device conforms to the Low Voltage Directive (Safety) 73/23/EEC as per EN 60950 Safety of Information Technology Equipment

Please note!

Product safety is guaranteed only when power is supplied to the device via a power source/adaptor approved according to EN60950-1, see section 2.5, and which does not exceed the given values.

7.2 Battery

The Danfoss Bluetooth® gateway is powered by a rechargeable Li-ion battery.

Temperature extremes can affect the ability of your battery to charge and can reduce the capacity and lifetime of the battery.

Therefore, do not leave the gateway with battery in vehicles, direct sunlight, or other places where the temperature may rise above 60°C or fall below 0°C.

Use the battery only for its intended purpose.

Do not expose the battery to water or extreme moisture.

Do not drop the battery or subject it to mechanical shocks.

Never use any charger or battery which is damaged.

Charge the battery after purchasing or when it has not been used for a long time.
The time required for full re-charging is approximately 2 hours.

Batteries should be charged in the original manufacturer's Li-ion specified charging equipment. Use of other chargers may cause excessive heat or even fire.

Do not open the gateway. Do not short-circuit the battery.

The battery should be replaced by authorized personnel only. Caution: Risk of explosion if battery is replaced by an incorrect type.

Please contact your dealer / manufacturer for service information.

Do not dispose of batteries in a fire! Dispose of batteries according to local regulations (e.g. recycling).

Do not dispose of as household waste.

8. Troubleshooting

8.1 Error message

The message “*please install driver for new hardware*” appears when connecting the gateway to the computer.

Solution: The Danfoss Bluetooth® Gateway operates on a driver which is normally installed as standard. Please contact the computer supplier to obtain a driver.

8.2 LED2 is flashing red

LED2 Sequence	Meaning
<p><i>LED flashes red for approx. 3 seconds in short, rapid bursts</i></p> 	<p>RS485 Bluetooth® gateway is defective. Solution: Please return for service.</p>

8.3 Top causes of errors

1. Parameter definition files are not imported.
Solution: Check the *Quick Start Guide* for the corresponding gateway.
2. Product keys are not installed.
Solution: Check the *Quick Start Guide* for the corresponding gateway.
3. Polarity on RS485 network interchanged.
Solution: Check your wiring.
4. Addressing on Modbus nodes not different to zero.
Solution: Check addressing of individual network nodes.
5. Mismatch in address range in Tool4Cool® and Modbus nodes.
Solution: Check addressing of individual network nodes.
6. Double addressing of Modbus nodes.
Solution: Check addressing of individual network nodes.

8.4 There is no connection between the computer and the device served by the gateway

A fault may have arisen in the pairing of the Bluetooth® gateway.

Solution: Remove the pairing, and then pair the device again according to 3. *Pairing the gateway*

1. Remove the pairing:
 Open Bluetooth® Devices in Control Panel (as shown in 3. *Pairing the gateway*)
 Click on the Danfoss Bluetooth® gateway, and then click on the Remove button.
2. Pair the devices again as shown in 3. *Pairing the gateway*

Many external Bluetooth® adapters are delivered with *BlueSoleil* software drivers. A test of the drivers shows that they may have problems with the communication speed of Tool4Cool® LabEdition. A solution to this can be to force Tool4Cool® LabEdition to insert delays in the communication.

Solution: This can be done by enabling *RS485* in the network setting of Tool4Cool® LabEdition. To enable RS485 in Tool4Cool® LabEdition please perform the following steps:

1. Disconnect.
2. In the *File* menu select “Connect Network”.

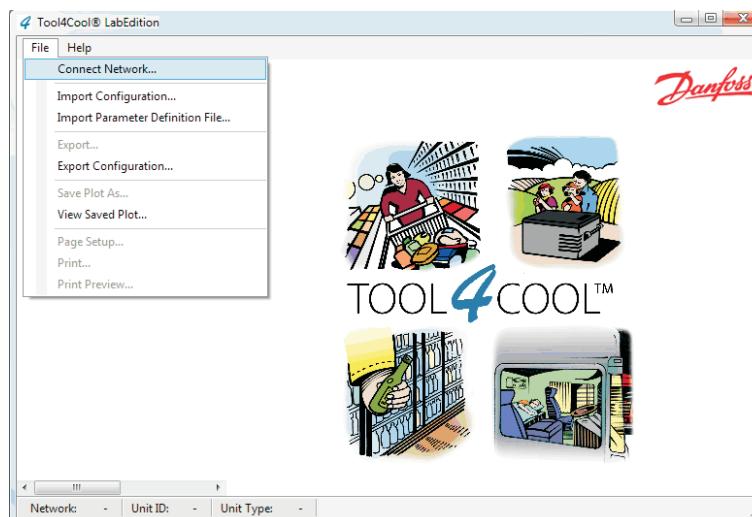

3. Select the Bluetooth® COM - port in the *Connect Using* menu.

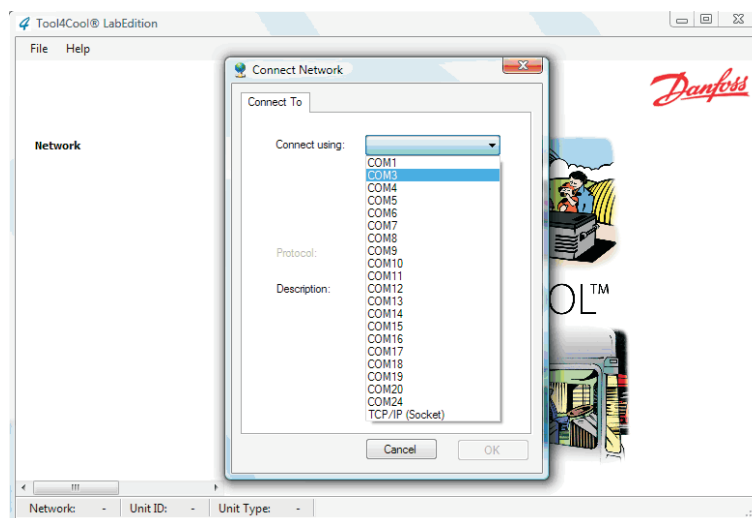

4. Press the *Configure* button in the *Connect Network* dialog.

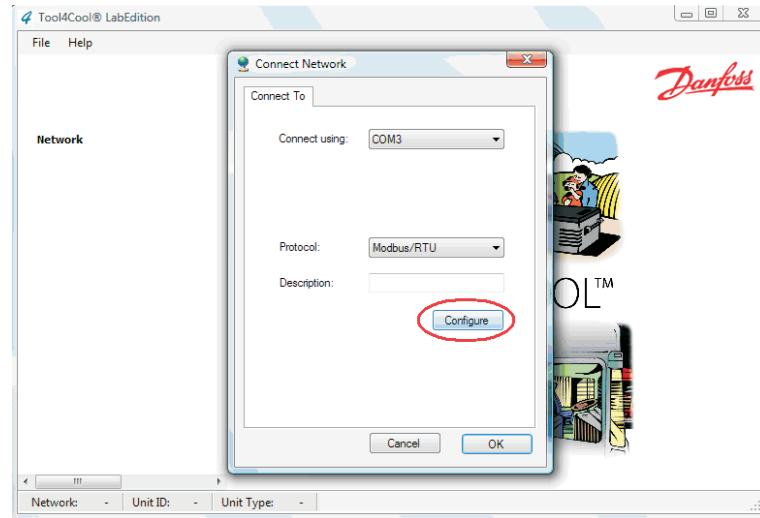

5. Select *True* in the *RS485* menu.

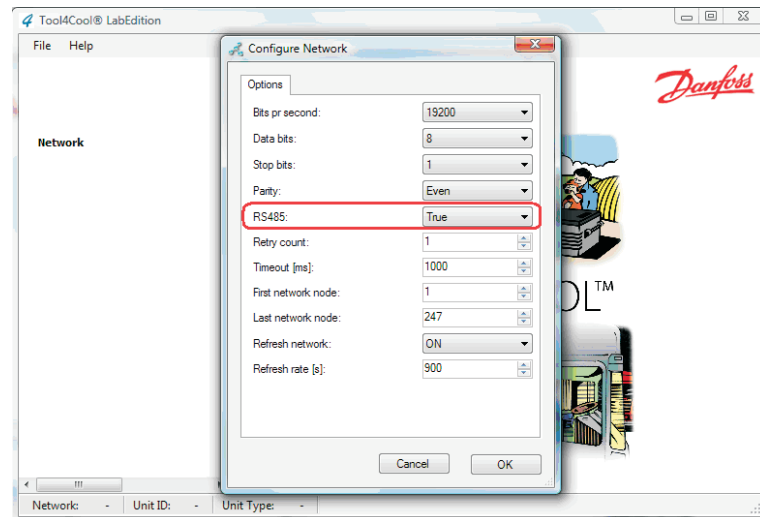

6. Press *OK* to confirm the change.

7. Press *OK* again to enable network.

