



Manual No.'22 · SRK-SM-349

updated November 22, 2022

## **SERVICE MANUAL**

# **INVERTER WALL MOUNTED TYPE RESIDENTIAL AIR-CONDITIONERS** (Split system, air to air heat pump type)

**Wireless LAN interface is standard equipment.**

SRK15ZTL-W

20ZTL-W

25ZTL-W

35ZTL-W

50ZTL-W

## CONTENTS

<b>1. OUTLINE OF OPERATION CONTROL BY MICROCOMPUTER.....</b>	<b>3</b>
(1) Operation control function by wireless remote control.....	3
(2) Unit ON/OFF button.....	4
(3) Auto restart function .....	4
(4) Installing two air-conditioners in the same room.....	4
(5) Selection of the annual cooling function .....	5
(6) Heating only function .....	5
(7) High power operation .....	5
(8) Economy operation.....	6
(9) Air flow direction adjustment .....	6
(10) 3D auto operation .....	7
(11) Timer operation.....	8
(12) Silent operation.....	9
(13) Night setback operation .....	9
(14) Air flow range setting .....	9
(15) Display brightness adjustment .....	10
(16) Wireless LAN connection function.....	10
(17) Fan control during heating thermostat OFF.....	10
(18) Outline of heating operation .....	11
(19) Outline of cooling operation .....	12
(20) Outline of dehumidifying (DRY) operation.....	13
(21) Outline of automatic operation .....	13
(22) Protective control function.....	14
 <b>2. MAINTENANCE DATA .....</b>	 <b>21</b>
(1) Cautions.....	21
(2) Items to check before troubleshooting .....	21
(3) Troubleshooting procedure (If the air-conditioner does not run at all).....	21
(4) Troubleshooting procedure (If the air-conditioner runs) .....	22
(5) Self-diagnosis table .....	23
(6) Service mode (Trouble mode access function).....	24
(7) Inspection procedures corresponding to detail of trouble.....	32
(8) Phenomenon observed after short-circuit, wire breakage on sensor.....	37
(9) Checking the indoor electrical equipment .....	37
(10) How to make sure of wireless remote control .....	39
(11) Inspection procedure for blown fuse on the indoor and outdoor unit PCB.....	39
(12) Outdoor unit inspection points .....	40

<b>3. ELECTRICAL WIRING .....</b>	<b>43</b>
<b>4. PIPING SYSTEM .....</b>	<b>46</b>
<b>5. INDOOR UNIT DISASSEMBLY METHOD .....</b>	<b>48</b>
<b>6. APPLICATION OPERATION MANUAL.....</b>	<b>54</b>

# 1. OUTLINE OF OPERATION CONTROL BY MICROCOMPUTER

## (1) Operation control function by wireless remote control

### Operation section

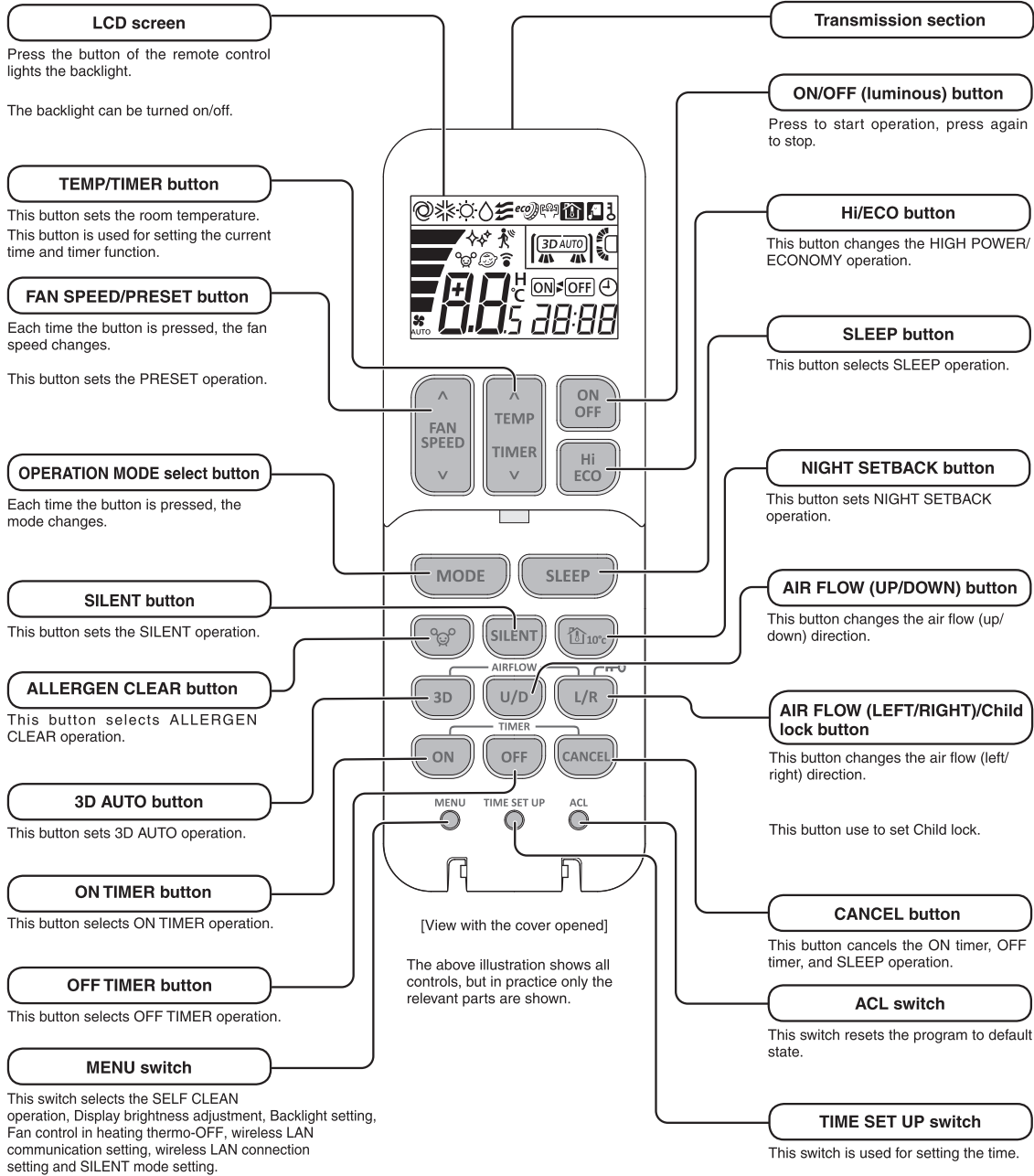

### Unit display section

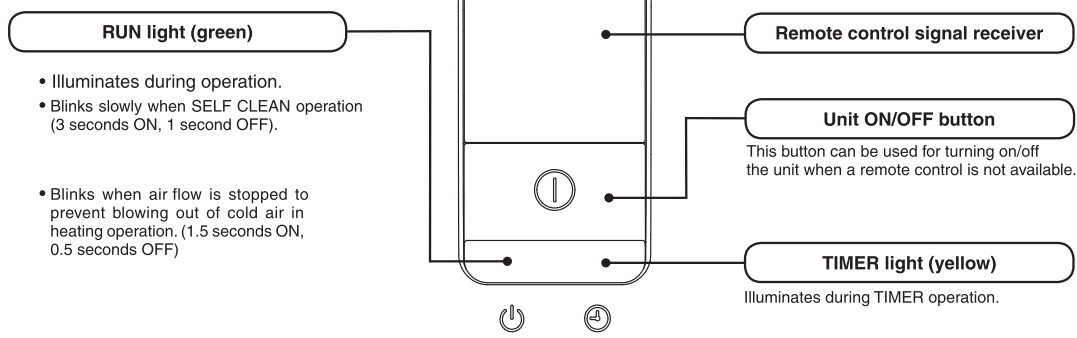



**(2) Unit ON/OFF button**

When the wireless remote control batteries become weak, or if the wireless remote control is lost or malfunctioning, this button may be used to turn the unit on and off.

**(a) Operation**

Push the button once to place the unit in the automatic mode. Push it once more to turn the unit off.

**(b) Details of operation**

The unit will go into the automatic mode in which it automatically determines, from room temperature (as detected by sensor), whether to go into the COOL or HEAT modes.

Function	Room temperature setting	Fan speed	Flap/Louver	Timer switch
Operation mode				
COOL	About 24°C	Auto	Auto	Continuous
HEAT	About 26°C			

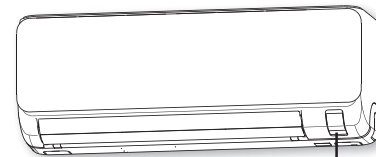

Unit ON/OFF button

**(3) Auto restart function**

- (a) Auto restart function records the operational status of the air-conditioner immediately prior to be switched off by a power cut, and then automatically resumes operations after the power has been restored.
- (b) The following settings will be cancelled:
  - (i) Timer settings
  - (ii) HIGH POWER operation

- Notes
- (1) Auto restart function is set at on when the air-conditioner is shipped from the factory. Consult with your dealer if this function needs to be switched off.
  - (2) When power failure occurs, the timer setting is cancelled. Once power is resumed, reset the timer.
  - (3) If the jumper wire (J1) "AUTO RESTART" is cut, auto restart is disabled. (See the diagram at right.)

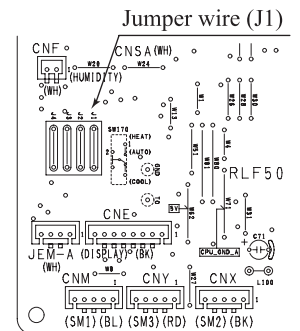

**(4) Installing two air-conditioners in the same room**

In case two air-conditioners are installed in the same room, apply this setting so that one unit can be operated with only one remote control.

**(a) Setting the wireless remote control**

- (i) Slide the cover and take out the batteries.
- (ii) Disconnect the switching line next to the battery with wire cutters.
- (iii) Set the batteries and cover again.

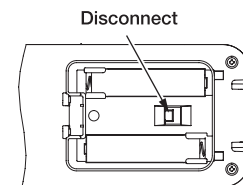

**(b) Setting an indoor unit**

- (i) Turn off the power source and turn it on after 1 minute.
- (ii) Point the wireless remote control (that was set according to the procedure described on the left side) at the indoor unit and send a signal by pressing the ACL switch on the wireless remote control. Since the signal is sent in about 6 seconds after the ACL switch is pressed, point the wireless remote control at the indoor unit for some time.
- (iii) Check that the reception buzzer sound "Peep" is emitted from the indoor unit. At completion of the setting, the indoor unit emits a buzzer sound "Peep". (If no reception sound is emitted, start the setting from the beginning again.)

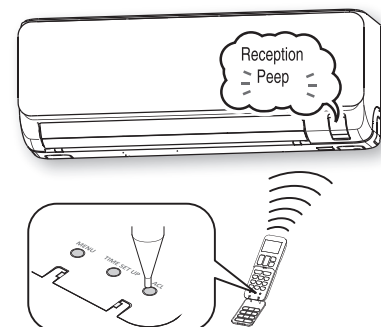

**(5) Selection of the annual cooling function**

- (a) The annual cooling control is valid from factory default setting. It is possible to disable by cutting jumper wire (J3), or changing the setting of DIP switch (SW2-4) on the interface kit (option) PCB if it is connected.

Jumper wire (J3)	Interface kit (SC-BIKN2-E) SW2-4	Function
Shorted	ON	Enabled
Shorted	OFF	Disabled
Open	ON	Disabled
Open	OFF	Disabled

Notes: (1) Default states of the jumper wire (J3) and the interface kit at the shipping from factory – On the PCB, the DIP switch (SW2-4) is set to enable the annual cooling function.

(2) To cancel the annual cooling setting, consult your dealer.

**(b) Content of control**

- (i) If the outdoor air temperature sensor (TH2) detects below 5°C, the indoor unit speed is switched to 8th step.
- (ii) If the outdoor air temperature sensor (TH2) detects higher than 10°C, the indoor fan speed is changed to the normal control speed.

Jumper wire (J3)

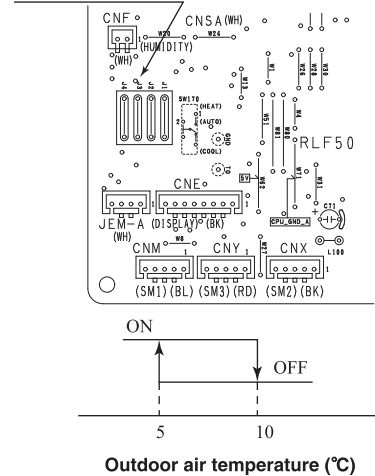

**(6) Heating only function**

- (a) Heating only function is enabled by disconnecting the jumper wire (J4).

**(b) Content of control**

Operation mode setting	Operation mode
COOL/DRY/FAN	FAN
AUTO/HEAT	HEAT

Jumper wire (J4)

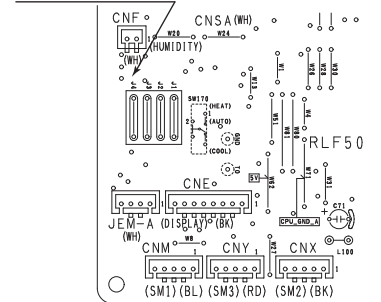

**(7) High power operation**

Pressing the HI POWER/ECONOMY button intensifies the operating power and initiates powerful cooling and heating operation for 15 minutes continuously. The wireless remote control displays HIGH POWER mark and the FAN SPEED display disappears.

- (a) During the HIGH POWER operation, the room temperature is not controlled. When it causes an excessive cooling and heating, press the HI POWER/ECONOMY button again to cancel the HIGH POWER operation.
- (b) HIGH POWER operation is not available during the DRY and the ON timer to OFF timer operations.
- (c) When HIGH POWER operation is set after ON timer operation, HIGH POWER operation will start from the set time.
- (d) When the following operation are set, HIGH POWER operation will be cancelled.
  - ① When the HI POWER/ECONOMY button is pressed again
  - ② When the operation mode is changed
  - ③ When it has been 15 minutes since HIGH POWER operation has started
  - ④ When the 3D AUTO button is pressed
  - ⑤ When the SILENT button is pressed
  - ⑥ When the NIGHT SETBACK button is pressed
- (e) Not operable while the air-conditioner is OFF.
- (f) After HIGH POWER operation, the sound of refrigerant flowing may be heard.

**(8) Economy operation**

Pressing the HI POWER/ECONOMY button initiates a soft operation with the power suppressed in order to avoid an excessive cooling or heating. The unit operate 1.5°C higher than the setting temperature during cooling or 2.5°C lower than that during heating. The wireless remote control displays ECONOMY mark and the FAN SPEED display disappears.

- (a) It will go into ECONOMY operation at the next time the air-conditioner runs in the following cases.
  - ① When the air-conditioner is stopped by ON/OFF button during ECONOMY operation
  - ② When the air-conditioner is stopped in SLEEP or OFF TIMER operation during ECONOMY operation
  - ③ When the operation is retrieved from CLEAN or ALLERGEN CLEAR operation
- (b) When the following operation are set, ECONOMY operation will be cancelled.
  - ① When the HI POWER/ECONOMY button is pressed again
  - ② When the operation mode is changed from DRY to FAN
  - ③ When the NIGHT SETBACK button is pressed
- (c) Not operable while the air-conditioner is OFF.
- (d) The setting temperature is adjusted according to the following table.

Item \ Mode	Cooling	Heating
Temperature adjustment	① +0.5	① -1.0
	② +1.0	② -2.0
	③ +1.5	③ -2.5

- ① at the start of operation.
- ② one hour after the start of operation.
- ③ two hours after the start of operation.

**(9) Air flow direction adjustment**



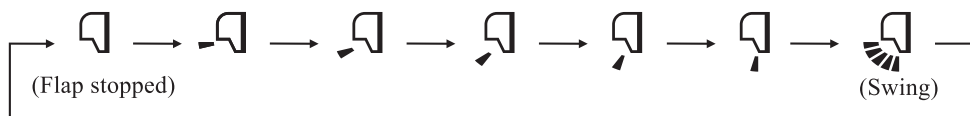

Air flow direction can be adjusted with by AIR FLOW  (UP/DOWN) and  (LEFT/RIGHT) button on the wireless remote control.

**(a) Flap**

Every time when you press the AIR FLOW  (UP/DOWN) button the mode changes as follows.



• Angle of flap from horizontal



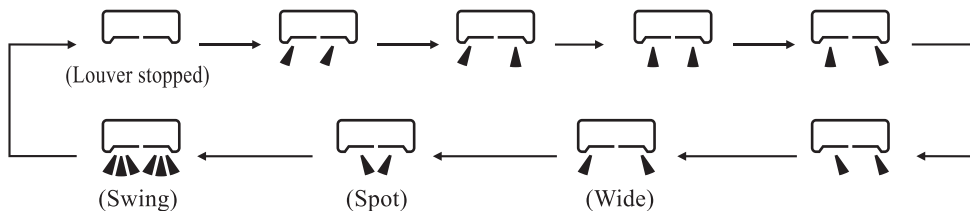

Wireless remote control display					
<b>COOL, DRY, FAN</b>	Approx. 20°	Approx. 30°	Approx. 40°	Approx. 50°	Approx. 65°
<b>HEAT</b>	Approx. 25°	Approx. 35°	Approx. 45°	Approx. 55°	Approx. 65°

**(b) Louver**

Every time when you press the AIR FLOW  (LEFT/RIGHT) button the mode changes as follows.



• Angle of louver

Wireless remote control display					
<b>Center installation</b>	Left approx. 30°	Left approx. 20°	Center	Right approx. 20°	Right approx. 30°
<b>Right end installation</b>	Left approx. 30°	Left approx. 20°	Left approx. 10°	Center	Center
<b>Left end installation</b>	Center	Center	Right approx. 10°	Right approx. 20°	Right approx. 30°

**(c) Swing**

(i) Swing flap

Flap moves in upward and downward directions continuously.

◆ In COOL, DRY, FAN operation

◆ In HEAT operation

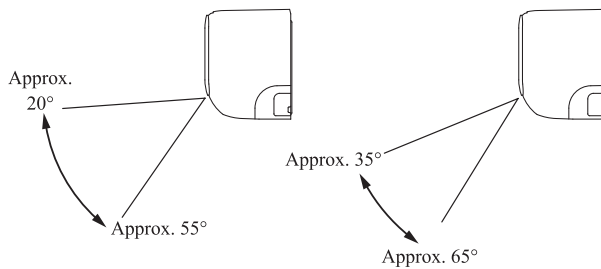

(ii) Swing louver

Louver moves in left and right directions continuously.



**(d) Memory flap (Flap or louver stopped)**

When you press the AIR FLOW (UP/DOWN or LEFT/RIGHT) button once while the flap or louver is operating, it stops swinging at the position. Since this angle is memorized in the microcomputer, the flap or louver will automatically be set at this angle when the next operation is started.

**(10) 3D auto operation**

Control the flap and louver by 3D AUTO button on the wireless remote control.

Fan speed and air flow direction are automatically controlled, allowing the entire indoor to efficiently conditioned.

(a) During cooling and heating (Including auto cooling and heating)

(i) Air flow selection is determined according to indoor temperature and setting temperature.

Operation mode	Air flow selection					
	AUTO		HI	MED	LO	ULO
Cooling	Room temp. – Setting temp. >5°C	Room temp. – Setting temp. ≤ 5°C	HI	MED	LO	ULO
	HIGH POWER	AUTO				
Heating	Setting temp. – Room temp. >5°C	Setting temp. – Room temp. ≤ 5°C	HI	MED	LO	ULO
	HIGH POWER	AUTO				

(ii) Air flow direction is controlled according to the room temperature and setting temperature.

1) When 3D auto operation starts

	Cooling	Heating
Flap	Up/down swing	
Louver	Wide (Fixed)	Center (Fixed)

2) When Room temp. – Setting temp. is ≤ 5°C during cooling and when setting temp. – Room temp. is ≤ 5°C during heating, the system switches to the following air flow direction control. After the louver swings left and right symmetrically for 3 cycles, control is switched to the control in 3).

	Cooling	Heating
Flap	Horizontal blowing (Fixed)	Slant forward blowing (Fixed)
Louver	Left/right swing	

3) After the flap swings for 5 cycles, control is switched to the control in 4).

	Cooling	Heating
Flap	Up/down swing	
Louver	Center (Fixed)	

4) For 5 minutes, the following air flow direction control is carried out.

	Cooling	Heating
<b>Flap</b>	Horizontal blowing (Fixed)	Slant forward blowing (Fixed)
<b>Louver</b>	Wide (Fixed)	

5) After 5 minutes have passed, the air flow direction is determined according to the room temperature and setting temperature.

Operation mode	Air flow direction control		
<b>Cooling</b>	Room temp. – Setting temp. $\leq 2^{\circ}\text{C}$	$2^{\circ}\text{C} < \text{Room temp.} - \text{Setting temp.} \leq 5^{\circ}\text{C}$	Room temp. – Setting temp. $> 5^{\circ}\text{C}$
	The control in 4) continues.	Control returns to the control in 2).	Control returns to the control in 1).
<b>Heating</b>	Setting temp. – Room temp. $\leq 2^{\circ}\text{C}$	$2^{\circ}\text{C} < \text{Setting temp.} - \text{Room temp.} \leq 5^{\circ}\text{C}$	Setting temp. – Room temp. $> 5^{\circ}\text{C}$
	The control in 4) continues.	Control returns to the control in 2).	Control returns to the control in 1).

(b) During DRY operation

<b>Flap</b>	Horizontal blowing (Fixed)
<b>Louver</b>	Wide (Fixed)

## (11) Timer operation

### (a) Comfort start-up (ON timer operation)

The unit starts the operation 5 to 60 minutes earlier so that the room can approach optimum temperature at ON timer.

### (b) Sleep timer operation

Pressing the SLEEP button causes the temperature to be controlled with respect to the set temperature.

### (c) OFF timer operation

The OFF timer can be set at a specific time (in 10-minute units) within a 24-hour period.

Note Timer operation from wireless remote control becomes invalid when you connect the interface kit (such as SC-BIKN2-E).

### (d) Combination of patterns which can be set for the timer operations

Item	Sleep timer	OFF timer	ON timer
Sleep timer		×	○
OFF timer	×		○
ON timer	○	○	

Notes (1) ○: Allowed ×: Not

(2) Since the ON timer, Sleep timer and OFF timer are set in parallel, when the times to turn ON and OFF the air-conditioner are duplicated, the setting of the OFF timer has priority.

Note Timer function used with wired remote control / WF-RAC (Smartphone)

The following timer functions that have be set from the wireless remote control are cancelled when the operating status of the indoor unit changes due to signals from the wired remote control or WF-RAC (Smartphone).

At this time, the operational status of the indoor unit is different from the wireless remote control display.

Therefore it is recommended to only set one of the timers.

- SLEEP TIMER operation
- OFF TIMER operation
- ON TIMER operation
- SLEEP TIMER + ON TIMER operation
- PROGRAM TIMER operation

**(12) Silent operation**

When the silent operation is set, the unit operates by dropping the outdoor fan speed and the compressor speed.

	SRK15ZTL-W				SRK20ZTL-W				SRK25ZTL-W			
	Mode1		Mode2		Mode1		Mode2		Mode1		Mode2	
	Cooling	Heating	Cooling	Heating	Cooling	Heating	Cooling	Heating	Cooling	Heating	Cooling	Heating
<b>Outdoor fan speed (Upper limit)</b>	4th speed	3th speed	4th speed	3th speed	4th speed	3th speed	4th speed	3th speed	4th speed	3th speed	4th speed	3th speed
<b>Compressor speed (Upper limit)</b>	21 rps	26 rps	15 rps	20 rps	32 rps	38 rps	15 rps	25 rps	38 rps	38 rps	20 rps	25 rps

	SRK35ZTL-W				SRK50ZTL-W			
	Mode1		Mode2		Mode1		Mode2	
	Cooling	Heating	Cooling	Heating	Cooling	Heating	Cooling	Heating
<b>Outdoor fan speed (Upper limit)</b>	4th speed	3th speed	4th speed	3th speed	4th speed	3th speed	3th speed	3th speed
<b>Compressor speed (Upper limit)</b>	49 rps	48 rps	32 rps	32 rps	54 rps	53 rps	36 rps	35 rps

- Model1 and Mode2 can be set only from remote control.
- Model1 and Mode2 can be switched as follows by remote control.

**1** Select the SILENT mode setting by pressing the MENU switch.

**2** Select the SILENT mode by pressing “^ or v (TEMP/TIMER)” button.

Initial display: 50  
 SILENT mode 1: 51  
 SILENT mode 2: 52

51 This mode can reduce the noise from the outdoor unit.  
 52 This mode is ever more silently than the SILENT mode 1.

**3** Press the ON/OFF button.

**(13) Night setback operation**

When the night setback operation is set, the heating operation starts with the setting temperature at 10°C.

**(14) Air flow range setting**

Take the air-conditioner location into account and adjust the left/right air flow range to maximize air-conditioning.

**(a) Setting**

- (i) If the air-conditioning unit is running, press the ON/OFF button to stop.  
The installation location setting cannot be made while the unit is running.
- (ii) Press the AIR FLOW U/D (UP/DOWN) button and the AIR FLOW L/R (LEFT/RIGHT) button together for 5 seconds or more.  
The installation location display illuminates.

(iii) Setting the air-conditioning installation location.  
Press the AIR FLOW L/R (LEFT/RIGHT) button and adjust to the desired location.

Each time the AIR FLOW L/R (LEFT/RIGHT) button is pre indicator is switched in the order of:

(i), (iv) ON/OFF button

(ii), (iii) U/D and L/R buttons

(ii) L/R button

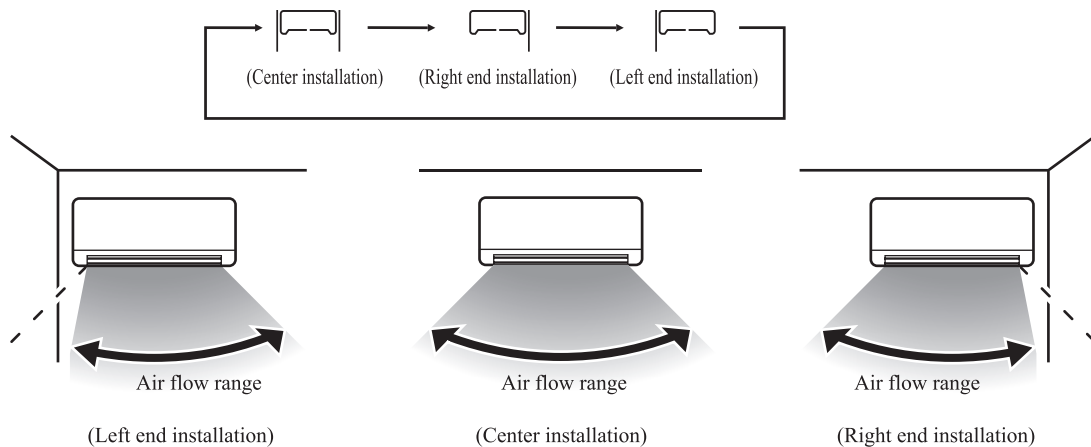

(iv) Press the ON/OFF button.

The air-conditioner's installation location is set.

Press within 60 seconds of setting the installation location (while the installation location setting display illuminates).

**(15) Display brightness adjustment**

This function can be used when it is necessary to adjust the brightness of unit display.

Brightness level	Run light	Timer light
LV2	100%	60%
LV1	50%	20%
LV0	0%	0%

Note When the unit displays self diagnosis or service mode, brightness level is always LV2.

**(16) Wireless LAN connection function**

**(a) Operating conditions**

When a signal of wireless LAN connection setting was received from a remote control during all air-conditioners stop

**(b) Detail of operation**

- (i) A signal which corresponds to the signal received from a remote control is sent to air-conditioner.
- (ii) A buzzer for confirmation of receipt rings.

**(c) Reset conditions**

When either of the following conditions is satisfied

- (i) When a reception complete signal was received from interface
- (ii) When an interface communication setting OFF signal was received from a remote control

**(17) Fan control during heating thermostat OFF**

- (i) Following fan controls during the heating thermostat OFF can be selected with the wireless remote control.
  - 1) Normal thermostat operation 2) Fireplace 3) Interval 4) Stop
- (ii) When the “Normal thermostat operation” is selected, the indoor fan is controlled by HOT KEEP.
- (iii) When the “Fireplace” is selected, it is operated with the set fan speed also in the thermostat OFF condition.
- (iv) If the “Interval” is selected, following controls are performed:
  - 1) If the thermostat is turned OFF during the heating operation, the indoor unit turns OFF the indoor fan.
  - 2) Indoor fan OFF is fixed for 5 minutes. After the 5 minutes, the indoor fan is operated at ① tap for 1 minute.
  - 3) After operating at ① tap for 1 minute, the indoor fan moves to the state of 1) above.
- (v) When the “Stop” is selected, the fan on the indoor unit of which the thermostat has been turned OFF, is turned OFF.

Note To use “Stop” function, additional work in which the suction temperature sensor can detect the room temperature appropriately is required. Otherwise, it may take time to return to heating and the heating capacity may be insufficient.

**(18) Outline of heating operation**

**(a) Operation of major functional components in heating mode**

	Heating		
	Thermostat ON	Thermostat OFF	Failure
Compressor	ON	OFF	OFF
Indoor fan motor	ON	ON(HOT KEEP)*	OFF
Outdoor fan motor	ON	OFF (few minutes ON)	OFF
4-way valve	ON	ON	OFF (3 minutes ON)

\*When a wired remote control is connected, a signal of a wired remote control is priority. HOT KEEP, Fireplace, Interval and Stop can be established.

In the case, indoor air temperature is detected by sensor on the wired remote control.

**(b) Details of control at each operation mode (pattern)**

**(i) Fuzzy operation**

Deviation between the indoor temperature setting correction temperature and the return air temperature is calculated in accordance with the fuzzy rule, and used for control of the air capacity and the compressor speed.

Model	SRK15	SRK20	SRK25	SRK35	SRK50
<b>Auto</b>	20-110rps	20-110rps	20-115rps	20-115rps	20-110rps
<b>HI</b>	20-110rps	20-110rps	20-115rps	20-115rps	20-110rps
<b>MED</b>	20-110rps	20-110rps	20-115rps	20-115rps	20-100rps
<b>LO</b>	20-60rps	20-70rps	20-84rps	20-96rps	20-80rps
<b>ULO</b>	20-44rps	20-44rps	20-50rps	20-50rps	20-50rps

When the defrost operation, protection device, etc. is actuated, operation is performed in the corresponding mode.

**(ii) Hot keep operation**

During the heating operation, the indoor fan speed can be controlled based on the temperature of the indoor heat exchanger (Th2) to prevent blowing out of cold air.

**(c) Defrost operation**

(i) Starting conditions (Defrost operation can be started only when all of the following conditions are satisfied.)

- 1) After start heating operation  
When it elapsed 35 minutes. (Total compressor operation time)
- 2) After finish of defrost operation  
When it elapsed 35 minutes. (Total compressor operation time)
- 3) Outdoor heat exchanger sensor (TH1) temperature  
When the temperature has been  $-5^{\circ}\text{C}$  or less for 3 minutes continuously.
- 4) The difference between the outdoor air sensor temperature and the outdoor heat exchanger sensor temperature is as following.

**Models SRK15-35**

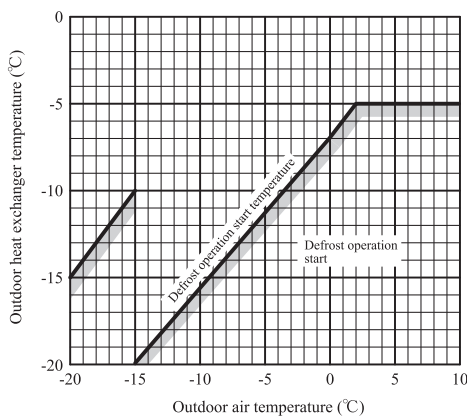

**Model SRK50**

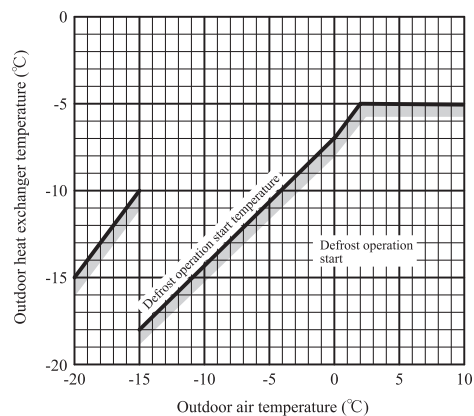



- 5) During continuous compressor operation  
In case satisfied all of following conditions.
  - Connect compressor speed 0 rps 10 times or more.
  - Satisfy 1), 2) and 3) conditions above.
  - Outdoor air temperature is 3°C or less.
- (ii) Ending conditions (Operation returns to the heating cycle when either one of the following is satisfied.)
  - 1) Outdoor heat exchanger sensor (TH1) temperature: 13°C (model SRK50 : 10°C) or higher  
For SRK15, 20, if the outdoor air temperature (TH2) is lower than -5°C, the outdoor heat exchanger temperature (TH1) is above 10°C or 5°C for more than 3 minutes continuously.
  - 2) Continued operation time of defrost operation → For more than 15 minutes
    - Defrost operation

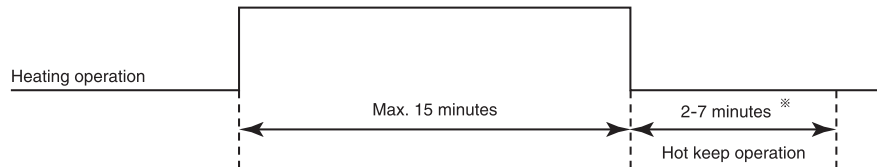

※Depends on an operation condition, the time can be longer than 7 minutes.

**(d) Countermeasure for excessive temperature rise**

If it feels excessive temperature rise in heating operation, setting temperature can be lower.

(i) Setting

Push ON/OFF button 30 seconds or more after turn on the power source and operate the air-conditioner at least once time, At completion of the setting, the indoor unit emits a buzzer sound “Pip”.

(ii) Contents of control

Unit : °C

	Signal of wireless remote control (Display)												
	18	19	20	21	22	23	24	25	26	27	28	29	30
Before setting	20	21	22	23	24	25	26	27	28	29	30	31	32
After setting	18	19	20	21	22	23	24	25	26	27	28	29	30

Note Setting temperature can be set in 0.5°C increments.

(iii) Reset condition

Push ON/OFF button 30 seconds or more during setting this mode. At completion of the reset, the indoor unit emits a buzzer sound “PiPiPi”.

**(19) Outline of cooling operation**

**(a) Operation of major functional components in cooling mode**

	Cooling		
	Thermostat ON	Thermostat OFF	Failure
Compressor	ON	OFF	OFF
Indoor fan motor	ON	ON	OFF
Outdoor fan motor	ON	OFF (few minutes ON)	OFF (few minutes ON)
4-way valve	OFF	OFF	OFF

**(b) Detail of control in each mode (Pattern)**

(i) Fuzzy operation

During the fuzzy operation, the air flow and the compressor speed are controlled by calculating the difference between the indoor temperature setting correction temperature and the return air temperature.

Model	SRK15	SRK20	SRK25	SRK35	SRK50
Fan speed					
Auto	15-66rps	15-70rps	15-76rps	15-98rps	20-100rps
HI	15-66rps	15-70rps	15-76rps	15-98rps	20-100rps
MED	15-52rps	15-56rps	15-60rps	15-80rps	20-82rps
LO	15-42rps	15-45rps	15-52rps	15-60rps	20-66rps
ULO	15-34rps	15-36rps	15-46rps	15-46rps	20-40rps

**(20) Outline of dehumidifying (DRY) operation**

**(a) Purpose of DRY mode**

The purpose is "Dehumidification", and not to control the humidity to the target condition. Indoor/outdoor unit control the operation condition to reduce the humidity, and also prevent over cooling.

**(b) Outline of control**

(i) Indoor unit fan speed and compressor are controlled by the area which is selected by the temperature difference.

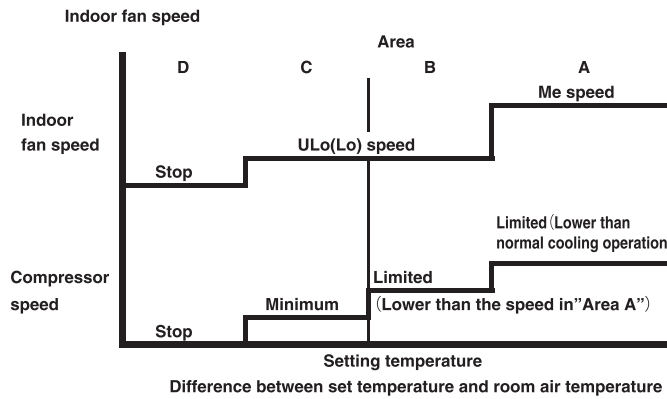

(ii) The indoor unit checks the current area by every 5 minutes, and operates by the next checking.

**(c) Other**

When the outdoor air temperature and room air temperature are low in cooling operation, indoor unit can not operate in cooling, and dehumidifying. In this case, the unit operates in heating to rise the room air temperature and after that start dehumidifying operation.

**(21) Outline of automatic operation**

**(a) Determination of operation mode**

Operation mode is determined by room air temperature and outdoor air temperature as following.

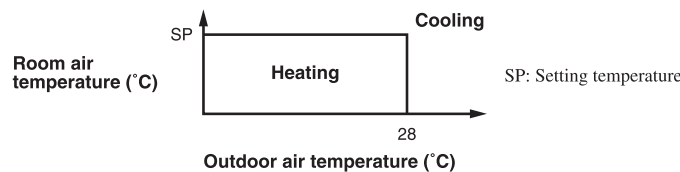

(b) Operation mode is changes when keep cooling and heating thermostat off 20 minutes and be satisfied with following conditions. If the setting temperature is changed with the remote control, the operation mode is judged immediately.

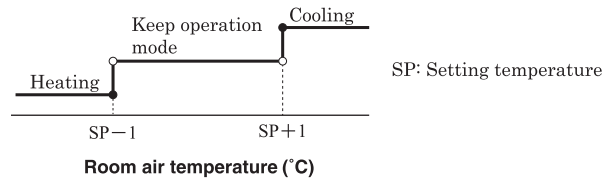

※It can not be changed to heating mode if outdoor air temperature is 28°C or higher.

- (c) When the unit is started again within one hour after the stop of automatic operation or when the automatic operation is selected during heating, cooling or DRY mode, the unit is operated in the previous operation mode.
- (d) Setting temperature can be adjusted within the following range. There is the relationship as shown below between the signals of the wireless remote control and the setting temperature.

		Signals of wireless remote control (Display)												
		18	19	20	21	22	23	24	25	26	27	28	29	30
Setting temperature	Cooling	18	19	20	21	22	23	24	25	26	27	28	29	30
	Heating	20	21	22	23	24	25	26	27	28	29	30	31	32

Note Setting temperature can be set in 0.5°C increments.

(e) When the unit is operated automatically with the wired remote control, the cooling operation is controlled according to the display temperatures while the setting temperature is compensated by +2°C during heating.

**(22) Protective control function**

**(a) Dew prevention control** (During cooling)

Prevents dewing on the indoor unit

**(i) Operating conditions**

When the following conditions have been satisfied for more than 30 minutes after starting operation

- 1) Compressor's speed is 26 (model SRK50:28) rps or higher.
- 2) Detected value of humidity is 68% or higher.

**(ii) Contents of operation**

- 1) Air capacity control

Model		SRK15	SRK20	SRK25, 35	SRK50
ULO	Upper limit of compressor's speed	RangeA: 34rps RangeB: 28rps	RangeA: 36rps RangeB: 28rps	RangeA: 46rps RangeB: 46rps	RangeA: 40rps RangeB: 28rps
	Indoor fan	4th speed			
LO	Upper limit of compressor's speed	RangeA: 42rps RangeB: 30rps	RangeA: 45rps RangeB: 30rps	RangeA: 46rps RangeB: 46rps	RangeA: 66rps RangeB: 28rps
	Indoor fan	5th speed		Adaptable to compressor speed	
AUTO, MED	Upper limit of compressor's speed	RangeA: 52rps RangeB: 52rps	RangeA: 56rps RangeB: 52rps	RangeA: 55rps RangeB: 55rps	RangeA: 82rps RangeB: 40rps
	Indoor fan	Adaptable to compressor speed			
HI	Upper limit of compressor's speed	RangeA: 66rps RangeB: 60rps	RangeA: 70rps RangeB: 60rps	RangeA: 60rps RangeB: 60rps	RangeA: 100rps RangeB: 50rps
	Indoor fan	7th speed		Adaptable to compressor speed	

Note Ranges A and B are as shown below.

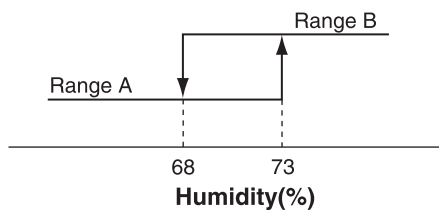

- 2) When this control has continued for more than 30 minutes continuously, the following wind direction control is performed.
  - a) When the vertical wind direction is set at other than the vertical swing, the flaps change to the horizontal position.
  - b) When the horizontal wind direction is set at other than the horizontal swing, the louver changes to the vertical position.

**(iii) Reset condition**

Humidity is less than 63%.

**(b) Frost prevention control** (During cooling or dehumidifying)

**(i) Operating conditions**

- 1) Indoor heat exchanger temperature (Th2) is lower than 5°C.
- 2) 5 minutes after reaching the compressor speed except 0 rps.

**(ii) Detail of anti-frost operation**

Indoor heat exchanger temperature	5°C or lower	2.5°C or lower
Lower limit of compressor command speed	22 rps(model SRK50 : 23 rps)	0 rps
Indoor fan	Depends on operation mode	Keep the fan speed before frost prevention control
Outdoor fan	Depends on compressor speed	Depends on stop mode
4-way valve	OFF	

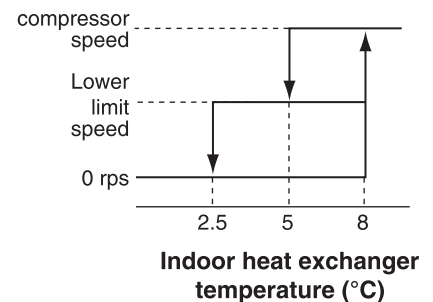

- Notes
- (1) When the indoor heat exchanger temperature is in the range of 2.5–5°C, the speed is reduced by 4 rps at each 20 seconds.
  - (2) When the temperature is lower than 2.5°C, the compressor is stopped.
  - (3) When the indoor heat exchanger temperature is in the range of 5–8°C, the compressor speed is been maintained.

**(iii) Reset conditions**

When either of the following condition is satisfied

- 1) The indoor heat exchanger temperature (Th2) is 8°C or higher.
- 2) The compressor speed is 0 rps.

**(c) Cooling overload protective control**

**(i) Operating conditions**

When the outdoor air temperature (TH2) has become continuously for 30 seconds at 41°C or more, or 47°C or more with the compressor running, the lower limit speed of compressor is brought up.

Item	SRK15-35		SRK50	
	41°C or more	47°C or more	41°C or more	47°C or more
Outdoor air temperature	41°C or more	47°C or more	41°C or more	47°C or more
Lower limit speed	30 rps	45 rps	27 rps	35 rps

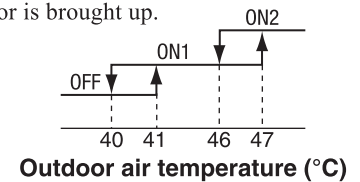

**(ii) Detail of operation**

- 1) The outdoor fan is stepped up by 3 speed step. [Upper limit 8th speed.]
- 2) The lower limit of compressor speed is set to 30 or 45 (model SRK50 : 27 or 35) rps.

However, when the thermo OFF, the speed is reduced to 0 rps.

**(iii) Reset conditions**

When either of the following condition is satisfied

- 1) The outdoor air temperature is lower than 40°C.
- 2) The compressor speed is 0 rps.

**(d) Cooling high pressure control**

**(i) Purpose**

Prevents anomalous high pressure operation during cooling

**(ii) Detector**

Outdoor heat exchanger sensor (TH1).

**(iii) Detail of operation**

**(Example) Compressor speed**

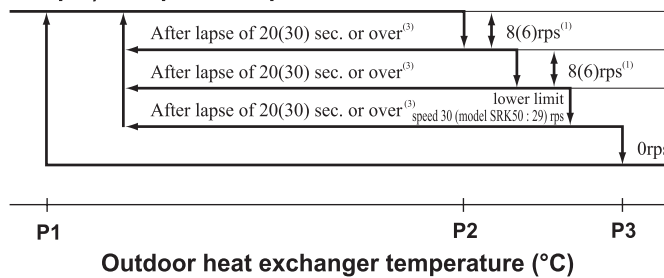

		TH1(°C)		
		P1	P2	P3
SRK15-35	Range A	40	43	46
	Range B	53	58	63
SRK50	Range A	48	53	55
	Range B	53	58	63

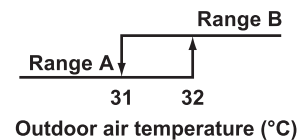

- Notes
- (1) When the outdoor heat exchanger temperature is in the range of P2-P3°C, the speed is reduced by 8(6) rps at each 20(30) seconds.
  - (2) When the temperature is P3 °C or higher, the compressor is stopped.
  - (3) When the outdoor heat exchanger temperature is in the range of P1-P2°C, if the compressor speed is been maintained and the operation has continued for more than 20(30) seconds at the same speed, it returns to the normal cooling operation.
  - (4) Values in ( ) are for the model SRK50.

**(e) Cooling low outdoor air temperature protective control**

**(i) Operating conditions**

When the outdoor air temperature (TH2) is C°C or lower for 20 seconds continuously while the compressor speed is other than 0 rps.

**(ii) Detail of operation**

- 1) It controls the upper and lower limit values for the compressor speed according to the following table.
- 2) It checks the outdoor air temperature (TH2) once every hour to judge the operation range.

	Compressor speed: Upper/lower limit (rps)						
	Lower 1		Upper 1	Lower 2	Upper 2	Lower 3	Upper 3
	Range B	Range A					
SRK15-35	30	Release	60	44	50	50	50
SRK50	27	Release	60	44	50	—	—

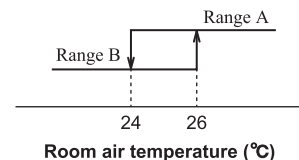

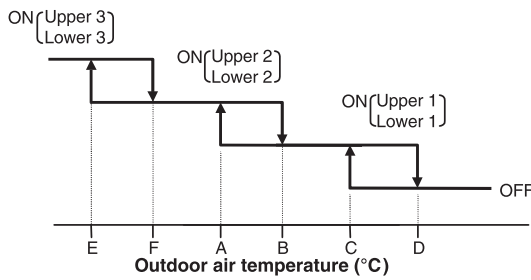

● Values of A, B, C, D, E, F (Models SRK15-35)

	Outdoor air temperature (°C)					
	E	F	A	B	C	D
First time	-8	-5	0	3	22	25
After the second times	-2	1	5	8	25	28

● Values of A, B, C, D (Model SRK50)

	Outdoor air temperature (°C)			
	A	B	C	D
First time	9	11	22	25
After the second times	16	19	25	28

(iii) Reset conditions

When either of the following condition is satisfied

- 1) The outdoor air temperature (TH2) is D°C or higher.
- 2) The compressor speed is 0 rps.

(f) Heating high pressure control

(i) Purpose

Prevents anomalous high pressure operation during heating

(ii) Detector

Indoor heat exchanger sensor (Th2)

(iii) Detail of operation

(Example)

Compressor speed

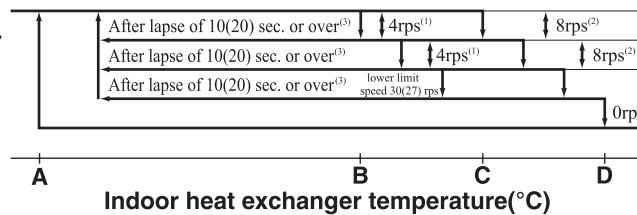

Note (1) Values in ( ) are for the model SRK50.

- Notes
- (1) When the indoor heat exchanger temperature is in the range of B-C °C, the speed is reduced by 4 rps at each 10(20) seconds.
  - (2) When the indoor heat exchanger temperature is in the range of C-D °C, the speed is reduced by 8 rps at each 10(20) seconds. When the temperature is D °C or higher continues for 1 minute, the compressor is stopped.
  - (3) When the indoor heat exchanger temperature is in the range of A-B °C, if the compressor speed is been maintained and the operation has continued for more than 10(20) seconds at the same speed, it returns to the normal heating operation.
  - (4) Indoor fan retains the fan speed when it enters in the high pressure control. Outdoor fan is operated in accordance with the speed.
  - (5) Values in ( ) are for the model SRK50.

● Temperature list  
Models SRK15-35

Unit : °C

	A	B	C	D
RPSmin < 50	47	52	54	58
50 ≤ RPSmin < 92	47.5	55	57	61
92 ≤ RPSmin ≤ 115	47.5 - 39	55 - 40	57 - 42	61

Note RPSmin: The lower one between the outdoor speed and the compressor speed

Model SRK50

Unit : °C

	A	B	C	D
RPSmin < 35	49	54	55	55.5
35 ≤ RPSmin < 40	49 - 52	54 - 57	55 - 58	55.5 - 62
40 ≤ RPSmin < 80	52	57	58	62
80 ≤ RPSmin < 115	52 - 43	57 - 46	58 - 47	62 - 52

Note RPSmin: The lower one between the outdoor speed and the compressor speed

**(g) Heating overload protective control**

**Outdoor unit side**

**• Models SRK15-35**

**1) Operating conditions**

When the outdoor air temperature (TH2) is 22°C or higher for 30 seconds continuously while the compressor speed other than 0 rps.

**2) Detail of operation**

- a) Taking the upper limit of compressor speed at 60 rps, if the output speed obtained with the fuzzy calculation exceeds the upper limit, the upper limit value is maintained.
- b) The lower limit of compressor speed is set to 40 rps and even if the calculated result becomes lower than that after fuzzy calculation, the speed is kept to 40 rps. However, when the thermostat OFF, the speed is reduced to 0 rps.
- c) Inching prevention control is activated and inching prevention control is carried out with the minimum speed set at 40 rps.
- d) The outdoor fan speed is set on 2nd speed.

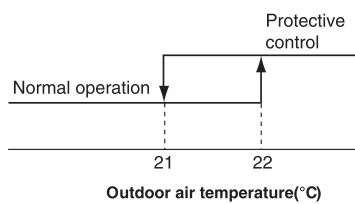

Compressor speed : Upper/lower limit (rps)			Outdoor fan speed
Lower limit		Upper limit	
Range A	Range B	60	2nd
40	Release		

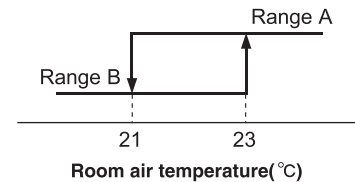

**3) Reset conditions**

The outdoor air temperature (TH2) is lower than 21°C.

**• Model SRK50**

**1) Operating conditions**

When the outdoor air temperature (TH2) is 11°C or higher for 30 seconds continuously while the compressor speed other than 0 rps.

**2) Detail of operation**

- a) Taking the upper limit of compressor speed range at 90 rps, if the output speed obtained with the fuzzy calculation exceeds the upper limit, the upper limit value is maintained.
- b) The lower limit of compressor speed is set to 27 rps and even if the calculated result becomes lower than that after fuzzy calculation, the speed is kept to 27 rps. However, when the thermostat OFF, the speed is reduced to 0 rps.
- c) Inching prevention control is activated and inching prevention control is carried out with the minimum speed set at 27 rps.
- d) Refer to the right table about the outdoor fan speed.

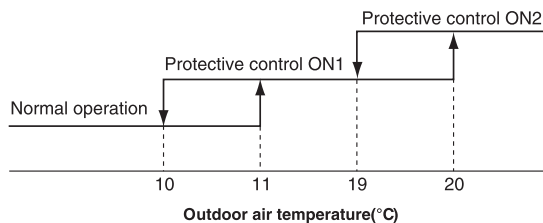

	Compressor speed : Upper/lower limit (rps)			Outdoor fan speed
	Lower limit		Upper limit	
	Range A	Range B		
ON1	27	Release	90	It depends on compressor speed
ON2	27	27	60	

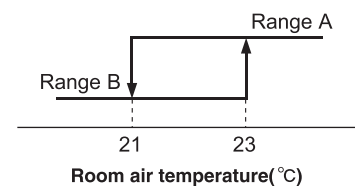

**3) Reset conditions**

The outdoor air temperature (TH2) is lower than 10°C.

**(h) Heating low outdoor temperature protective control**

**• Models SRK15-35**

**(i) Operating conditions**

When the outdoor air temperature (TH2) is lower than 2°C for 30 seconds continuously while the compressor speed is other than 0 rps

**(ii) Detail of operation**

The lower limit compressor speed is change as shown in the figure below.

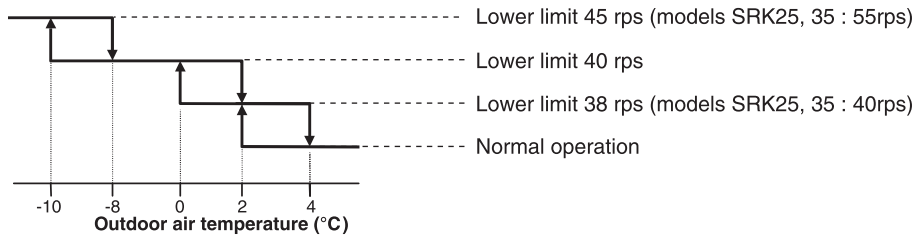

**(iii) Reset conditions**

When either of the following condition is satisfied

- 1) The outdoor air temperature (TH2) becomes 4°C.
- 2) The compressor speed is 0 rps.

**• Model SRK50**

**(i) Operating conditions**

When the outdoor air temperature (TH2) is lower than 4°C for 30 seconds continuously while the compressor speed is other than 0 rps

**(ii) Detail of operation**

The lower limit compressor speed is change as shown in the figure below.

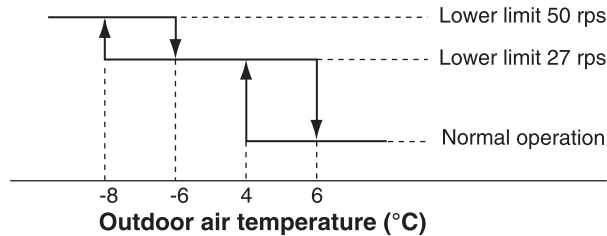

**(iii) Reset conditions**

When either of the following condition is satisfied

- 1) The outdoor air temperature (TH2) becomes 6°C.
- 2) The compressor speed is 0 rps.

**(i) Compressor overheat protection**

**(i) Purpose**

It is designed to prevent deterioration of oil, burnout of motor coil and other trouble resulting from the compressor overheat.

**(ii) Detail of operation**

- 1) Speeds are controlled with temperature detected by the sensor (TH3) mounted on the discharge pipe.

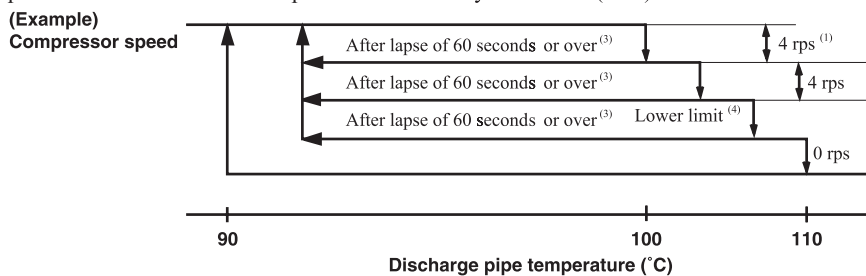

- Notes
- (1) When the discharge pipe temperature is in the range of 100-110°C, the speed is reduced by 4 rps.
  - (2) When the discharge pipe temperature is raised and continues operation for 20 seconds without changing, then the speed is reduced again by 4 rps.
  - (3) If the discharge pipe temperature is in the range of 90-100°C even when the compressor speed is maintained for 60 seconds when the temperature is in the range of 90-100°C, the speed is raised by 1 rps and kept at that speed for 60 seconds. This process is repeated until the command speed is reached.
  - (4) Lower limit speed

Model	Mode		
	Cooling	Heating	
Lower limit speed	SRK15 - 35	15 rps	20 rps
	SRK50	20 rps	20 rps

- 2) If the temperature of 110°C is detected by the sensor on the discharge pipe, then the compressor will stop immediately. When the discharge pipe temperature drops and 3 minutes has elapsed, the unit starts again within 1 hour but there is no start at the third time.

**(j) Current safe**

**(i) Purpose**

Current is controlled not to exceed the upper limit of the setting operation current.

**(ii) Detail of operation**

Input current to the converter is monitored with the current sensor fixed on the printed circuit board of the outdoor unit and, if the operation current value reaches the limiting current value, the compressor speed is reduced.

If the mechanism is actuated when the compressor speed is less than 30 rps, the compressor is stopped immediately.

Operation starts again after 3 minutes.

**(k) Current cut**

**(i) Purpose**

Inverter is protected from overcurrent.

**(ii) Detail of operation**

Output current from the inverter is monitored with a shunt resistor and, if the current exceeds the setting value, the compressor is stopped immediately. Operation starts again after 3 minutes.

**(l) Outdoor unit failure**

This is a function for determining when there is trouble with the outdoor unit during air-conditioning.

The compressor is stopped if any one of the following in item (i), (ii) is satisfied. Once the unit is stopped by this function, it is not restarted.

- (i) When the input current is measured at 1 A or less for 3 continuous minutes or more.
- (ii) If the outdoor unit sends a 0 rps signal to the indoor unit 3 times or more within 20 minutes of the power being turned on.

**(m) Indoor fan motor protection**

When the air-conditioner is operating and the indoor fan motor is turned ON, if the indoor fan motor has operated at 300 min<sup>-1</sup> or under for more than 30 seconds, the unit enters first in the stop mode and then stops the entire system.

**(n) Serial signal transmission error protection**

**(i) Purpose**

Prevents malfunction resulting from error on the indoor ↔ outdoor signals

**(ii) Detail of operation**

If the compressor is operating and a serial signal cannot be received from the indoor control with outdoor control having serial signals continues for 7 minutes and 35 seconds, the compressor is stopped.

After the compressor has been stopped, it will be restarted after the compressor start delay if a serial signal can be received again from the indoor control.

**(o) Rotor lock**

If the motor for the compressor does not turn after it has been started, it is determined that a compressor lock has occurred and the compressor is stopped.

**(p) Outdoor fan motor protection**

If the outdoor fan motor has operated at 75 min<sup>-1</sup> or under for more than 30 seconds, the compressor and fan motor are stopped.



**(q) Outdoor fan control at low outdoor temperature**

**(i) Cooling**

**1) Operating conditions**

When the outdoor air temperature (TH2) is 22°C or lower for 30 seconds continuously while the compressor speed is other than 0 rps.

**2) Detail of operation**

After the outdoor fan operates at A speed for 60 seconds; the corresponding outdoor heat exchanger temperature shall implement the following controls.

● Value of A

	Outdoor fan
Outdoor temperature > 15°C	3rd speed
15°C ≥ Outdoor temperature > 0°C	2nd speed
Outdoor temperature ≤ 0°C	1st speed

- a) Outdoor heat exchanger temperature (TH1) ≤ 21°C  
After the outdoor fan speed drops (down) to 1 speed for 60 seconds; if the outdoor heat exchanger temperature is lower than 21°C, gradually reduce the outdoor fan speed by 1 speed. (Lower limit ;TH2>0°C:2nd speed, TH2 ≤ 0°C :1st speed)
- b) 21°C < Outdoor heat exchanger temperature (TH1) ≤ 38°C  
After the outdoor fan speed maintains at A speed for 20 seconds; if the outdoor heat exchanger temperature is 21°C-38°C, maintain outdoor fan speed.
- c) Outdoor heat exchanger temperature (TH1) > 38°C  
After the outdoor fan speed rises (up) to 1 speed for 60 seconds; if the outdoor heat exchanger temperature is higher than 38°C, gradually increase outdoor fan speed by 1 speed. (Upper limit 3rd speed)

**3) Reset conditions**

When either of the following conditions is satisfied

- a) The outdoor air temperature (TH2) is 24°C or higher.
- b) The compressor command speed is 0 rps.

**(ii) Heating**

**1) Operating conditions**

When the outdoor air temperature (TH2) is 4°C or lower for 30 seconds continuously while the compressor command speed is other than 0 rps.

**2) Detail of operation**

The outdoor fan is stepped up by 2 speed step at each 20 seconds. (Upper limit 8th speed (In addition SRC15-35 : 2 speed step up corresponding to inverter number of rotations when the outdoor air temperature (TH2) is 4°C or lower))

**3) Reset conditions**

When either of the following conditions is satisfied

- a) The outdoor air temperature (TH2) is 6°C or higher.
- b) The compressor command speed is 0 rps.

**(r) Refrigeration cycle system protection**

**(i) Starting conditions**

- 1) When 5 minutes have elapsed after the compressor ON or the completion of the defrost operation
- 2) Other than the defrost operation
- 3) When, after satisfying the conditions of 1) and 2) above, the compressor speed, room air temperature (Th1) and indoor heat exchanger temperature (Th2) have satisfied the conditions in the following table for 10(SRK50:5) minutes

Operation mode	Compressor speed (N)	Room air temperature (Th1)	Room air temperature (Th1)/ Indoor heat exchanger temperature (Th2)
Cooling	50 ≤ N	10 ≤ Th1 ≤ 40	Th1 - 4 < Th2
Heating <sup>*)</sup>	50 ≤ N	0 ≤ Th1 ≤ 40	Th2 < Th1 + 6

Note Except that the fan speed is Hi in heating operation.

**(ii) Contents of control**

- 1) When the conditions of (i) above are satisfied , the compressor stops.
- 2) Error stop occurs when the compressor has stopped 3 times within 60 minutes.

**(iii) Reset condition**

When the compressor has been turned OFF

## 2. MAINTENANCE DATA

### (1) Cautions

- (a) If you are disassembling and checking an air-conditioner, be sure to turn off the power before beginning. When working on indoor units, let the unit sit for about 1 minute after turning off the power before you begin work. When working on an outdoor unit, there may be an electrical charge applied to the main circuit (electrolytic condenser), so begin work only after discharging this electrical charge (to DC10V or lower).
- (b) When taking out printed circuit boards, be sure to do so without exerting force on the circuit boards or package components.
- (c) When disconnecting and connecting connectors, take hold of the connector housing and do not pull on the lead wires.

### (2) Items to check before troubleshooting

- (a) Have you thoroughly investigated the details of the trouble which the customer is complaining about?
- (b) Is the air-conditioner running? Is it displaying any self-diagnosis information?
- (c) Is a power source with the correct voltage connected?
- (d) Are the control lines connecting the indoor and outdoor units wired correctly and connected securely?
- (e) Is the outdoor unit's service valve open?

### (3) Troubleshooting procedure (If the air-conditioner does not run at all)

If the air-conditioner does not run at all, diagnose the trouble using the following troubleshooting procedure. If the air-conditioner is running but breaks down, proceed to troubleshooting step (4).

**Important** When all the following conditions are satisfied, we say that the air-conditioner will not run at all.

- (a) The RUN light does not light up.
- (b) The flaps do not open.
- (c) The indoor unit fan motors do not run.
- (d) The self-diagnosis display does not function.

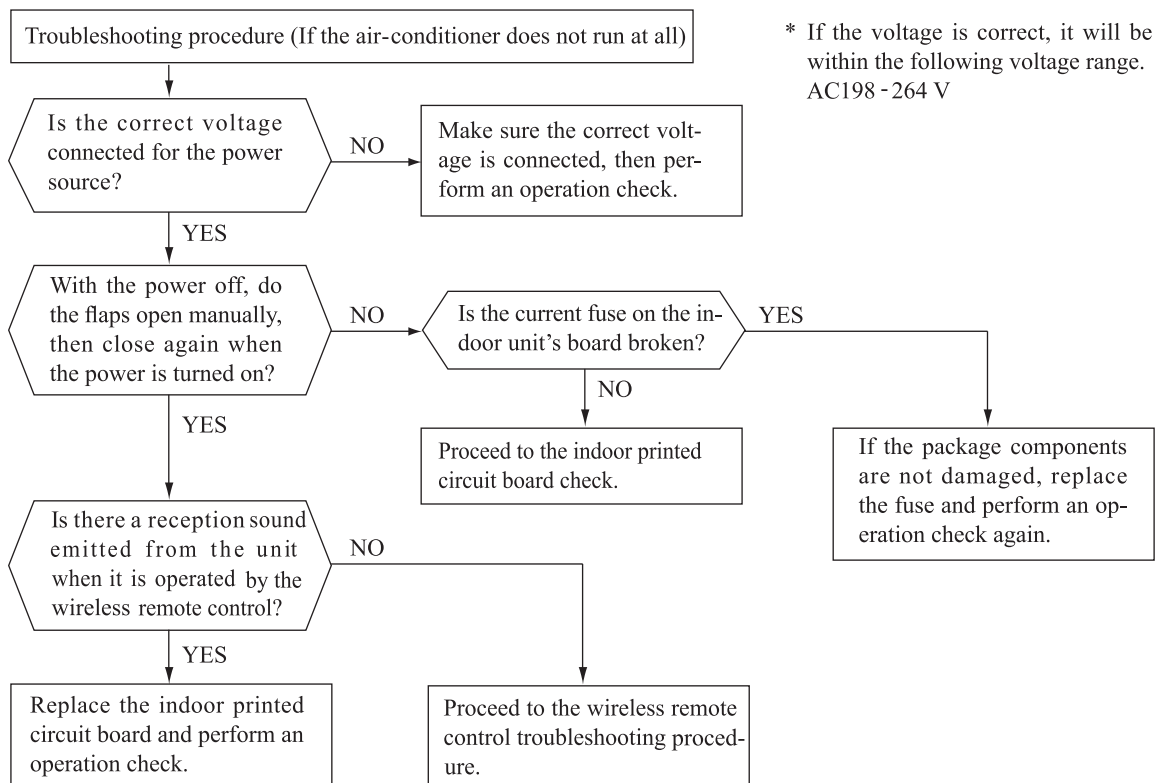

(4) Troubleshooting procedure (If the air-conditioner runs)

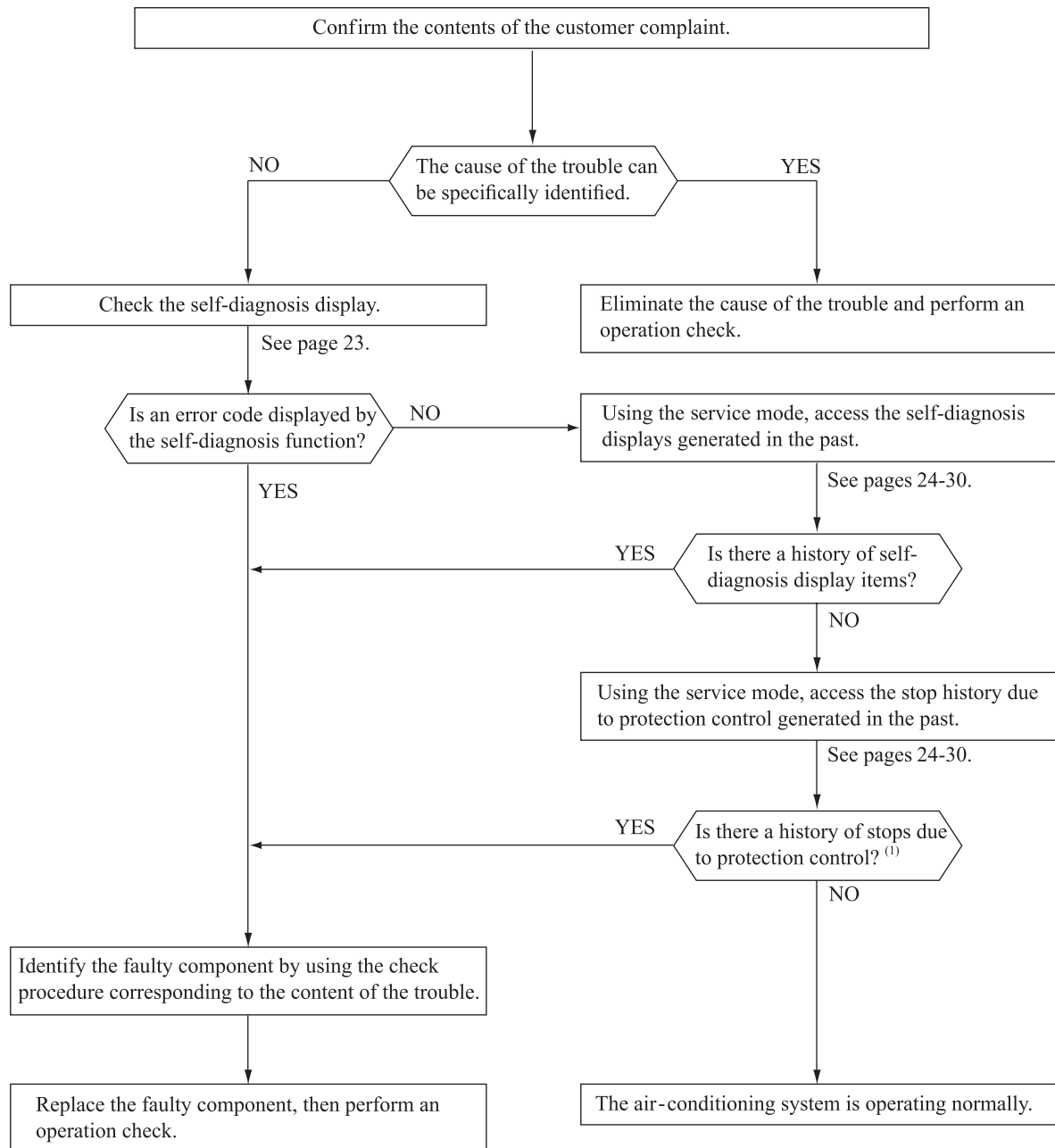

Note (1) Even in cases where only intermittent stop data are generated, the air-conditioning system is normal. However, if the same protective operation recurs repeatedly (3 or more times), it will lead to customer complaints. Judge the conditions in comparison with the contents of the complaints.

(5) Self-diagnosis table

When this air-conditioner performs an emergency stop, the reason why the emergency stop occurred is displayed by the flashing of display lights. If the air-conditioner is operated using the remote control 3 minutes or more after the emergency stop, the trouble display stops and the air-conditioner resumes operation. <sup>(1)</sup>

Indoor unit display panel		Wired <sup>(2)</sup> remote control display	Description of trouble	Cause	Display (flashing) condition
RUN light	TIMER light				
1-time flash	ON	—	Heat exchanger temperature sensor 1 error	<ul style="list-style-type: none"> <li>Broken heat exchanger temperature sensor 1 wire, poor connector connection</li> <li>Indoor unit PCB is faulty</li> </ul>	When a heat exchanger temperature sensor 1 wire disconnection is detected while operation is stopped. (If a temperature of -28°C or lower is detected for 15 seconds, it is judged that the wire is disconnected.) (Not displayed during operation.)
2-time flash	ON	—	Room air temperature sensor error	<ul style="list-style-type: none"> <li>Broken room temperature sensor wire, poor connector connection</li> <li>Indoor unit PCB is faulty</li> </ul>	When a room temperature sensor wire disconnection is detected while operation is stopped. (If a temperature of -45°C or lower is detected for 15 seconds, it is judged that the wire is disconnected.) (Not displayed during operation.)
3-time flash	ON	—	Heat exchanger temperature sensor 2 error	<ul style="list-style-type: none"> <li>Broken heat exchanger temperature sensor 2 wire, poor connector connection</li> <li>Indoor unit PCB is faulty</li> </ul>	When a heat exchanger temperature sensor 2 wire disconnection is detected while operation is stopped. (If a temperature of -28°C or lower is detected for 15 seconds, it is judged that the wire is disconnected.) (Not displayed during operation.)
6-time flash	ON	E 16	Indoor fan motor error	<ul style="list-style-type: none"> <li>Defective fan motor, poor connector connection</li> </ul>	When conditions for turning the indoor fan motor on exist during air-conditioner operation, an indoor fan motor speed of 300min <sup>-1</sup> or lower is measured for 30 seconds or longer. (The air-conditioner stops.)
Keeps flashing	1-time flash	E 38	Outdoor air temperature sensor error	<ul style="list-style-type: none"> <li>Broken outdoor air temperature sensor wire, poor connector connection</li> <li>Outdoor unit PCB is faulty</li> </ul>	-55°C or lower is detected for 5 seconds continuously 3 times within 40 minutes after initial detection of this anomalous temperature. Or -55°C or higher is detected for within 20 seconds after power ON. (The compressor is stopped.)
Keeps flashing	2-time flash	E 37	Outdoor heat exchanger temperature sensor error	<ul style="list-style-type: none"> <li>Broken heat exchanger temperature sensor wire, poor connector connection</li> <li>Outdoor unit PCB is faulty</li> </ul>	-55°C or lower is detected for 5 seconds continuously 3 times within 40 minutes after initial detection of this anomalous temperature. Or -55°C or higher is detected for within 20 seconds after power ON. (The compressor is stopped.)
Keeps flashing	4-time flash	E 39	Discharge pipe temperature sensor error	<ul style="list-style-type: none"> <li>Broken discharge pipe temperature sensor wire, poor connector connection</li> <li>Outdoor unit PCB is faulty</li> </ul>	-25°C or lower is detected for 5 seconds continuously 3 times within 40 minutes after initial detection of this anomalous temperature. (The compressor is stopped.)
ON	1-time flash	E 42	Current cut	<ul style="list-style-type: none"> <li>Compressor locking, open phase on compressor output, short-circuit on power transistor, service valve is closed</li> </ul>	The compressor output current exceeds the set value during compressor start. (The air-conditioner stops.)
ON	2-time flash	E 59	Trouble of outdoor unit	<ul style="list-style-type: none"> <li>Broken compressor wire</li> <li>Compressor blockage</li> </ul>	When there is an emergency stop caused by trouble in the outdoor unit, or the input current value is found to be lower than the set value. (The air-conditioner stops.)
ON	3-time flash	E 58	Current safe stop	<ul style="list-style-type: none"> <li>Overload operation</li> <li>Overcharge</li> <li>Compressor locking</li> </ul>	When the compressor command speed is lower than the set value and the current safe has operated. (The compressor stops)
ON	4-time flash	E 51	Power transistor error	<ul style="list-style-type: none"> <li>Broken power transistor</li> </ul>	When the power transistor is judged breakdown while compressor starts. (The compressor is stopped.)
ON	5-time flash	E 36	Over heat of compressor	<ul style="list-style-type: none"> <li>Gas shortage, defective discharge pipe temperature sensor, service valve is closed</li> </ul>	When the value of the discharge pipe temperature sensor exceeds the set value. (The air-conditioner stops.)
ON	6-time flash	E 5	Error of signal transmission	<ul style="list-style-type: none"> <li>Defective power source, Broken signal wire, defective indoor/outdoor unit PCB</li> </ul>	When there is no signal between the indoor unit PCB and outdoor unit PCB for 10 seconds or longer (when the power is turned on), or when there is no signal for 7 minute 35 seconds or longer (during operation) (the compressor is stopped).
ON	7-time flash	E 48	Outdoor fan motor error	<ul style="list-style-type: none"> <li>Defective fan motor, poor connector connection</li> </ul>	When the outdoor fan motor speed continues for 30 seconds or longer at 75 min <sup>-1</sup> or lower. (3 times) (The air-conditioner stops.)
ON	Keeps flashing	E 35	Cooling high pressure protection	<ul style="list-style-type: none"> <li>Overload operation, overcharge</li> <li>Broken outdoor heat exchanger temperature sensor wire</li> <li>Service valve is closed</li> </ul>	When the value of the outdoor heat exchanger temperature sensor exceeds the set value.
2-time flash	2-time flash	E 60	Rotor lock	<ul style="list-style-type: none"> <li>Defective compressor</li> <li>Open phase on compressor</li> <li>Defective outdoor unit PCB</li> </ul>	If the compressor motor's magnetic pole positions cannot be correctly detected when the compressor starts. (The air-conditioner stops.)
4-time flash	ON	—	Trouble of wireless LAN interface	<ul style="list-style-type: none"> <li>Defective wireless LAN interface boards, poor connector connection</li> </ul>	When normal data cannot be received from wireless LAN interface for two minutes continuously
5-time flash	ON	E 47	Active filter voltage error	<ul style="list-style-type: none"> <li>Defective active filter</li> </ul>	When the wrong voltage connected for the power source. When the outdoor unit PCB is faulty
7-time flash	ON	E 57	Refrigeration cycle system protective control	<ul style="list-style-type: none"> <li>Service valve is closed.</li> <li>Refrigerant is insufficient</li> </ul>	When refrigeration cycle system protective control operates.
7-time flash	1-time flash	E 40	Service valve (gas side) closed operation	<ul style="list-style-type: none"> <li>Service valve (gas side) closed</li> <li>Defective outdoor unit PCB</li> </ul>	If the output current of inverter exceeds the specifications, it makes the compressor stopping. (In heating mode). After 3-minute delay, the compressor restarts, but if this anomaly occurs 2 times within 20 minutes after the initial detection.
—	—	E 1	Error of wired remote control wiring	<ul style="list-style-type: none"> <li>Broken wired remote control wire, defective indoor unit PCB</li> </ul>	The wired remote control wire Y is open. The wired remote control wires X and Y are reversely connected. Noise is penetrating the wired remote control lines. The wired remote control or indoor unit PCB is faulty. (The communications circuit is faulty.)

Notes (1)The air-conditioner cannot be restarted using the remote control for 3 minutes after operation stops.

(2)The wired remote control is option parts.

**(6) Service mode (Trouble mode access function)**

This air-conditioner is capable of recording error displays and protective stops (service data) which have occurred in the past. If self-diagnosis displays cannot be confirmed, it is possible to get a grasp of the conditions at the time trouble occurred by checking these service data.

**(a) Explanation of terms**

Term	Explanation
<b>Service mode</b>	The service mode is the mode where service data are displayed by flashing of the display lights when the operations in item (b) below are performed with the indoor control.
<b>Service data</b>	These are the contents of error displays and protective stops which occurred in the past in the air-conditioner system. Error display contents and protective stop data from past anomalous operations of the air-conditioner system are saved in the indoor unit control's non-volatile memory (memory which is not erased when the power goes off). There are two types of data, self-diagnosis data and stop data, described below.
<b>Self-diagnosis data</b>	These are the data which display the reason why a stop occurred when an error display(self-diagnosis display) occurred in an indoor unit. Data are recorded for up to 5 previous occurrences. Data which are older than the 5th previous occurrence are erased. In addition, data on the temperature of each sensor (room temperature, indoor heat exchanger, outdoor heat exchanger, outdoor air temperature, discharge pipe), remote control information (operation switching, fan speed switching) are recorded when trouble occurs, so more detailed information can be checked.
<b>Stop data</b>	These are the data which display the reason by a stop occurred when the air-conditioning system performed protective stops, etc. in the past. Even if stop data alone are generated, the system restarts automatically. (After executing the stop mode while the display is normal, the system restarts automatically.) Data for up to 10 previous occasions are stored. Data older than the 10th previous occasion are erased. ( Important) In cases where transient stop data only are generated, the air-conditioner system may still be normal. However, if the same protective stop occurs frequently (3 or more times), it could lead to customer complaints.

**(b) Service mode display procedure**

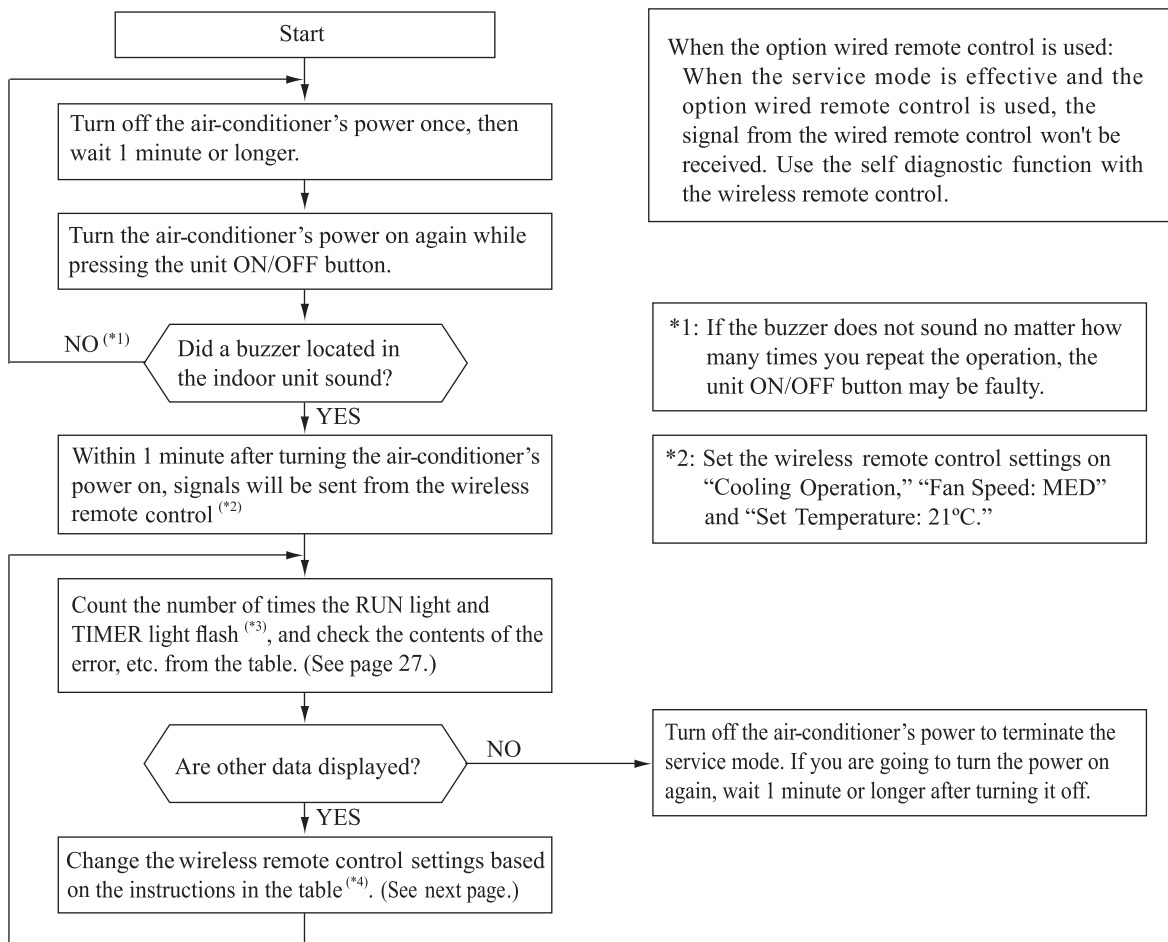

\*3: To count the number of flashes in the service mode, count the number of flashes after the light lights up for 1.5 second initially (start signal). (The time that the light lights up for 1.5 second (start signal) is not counted in the number of flashes.)

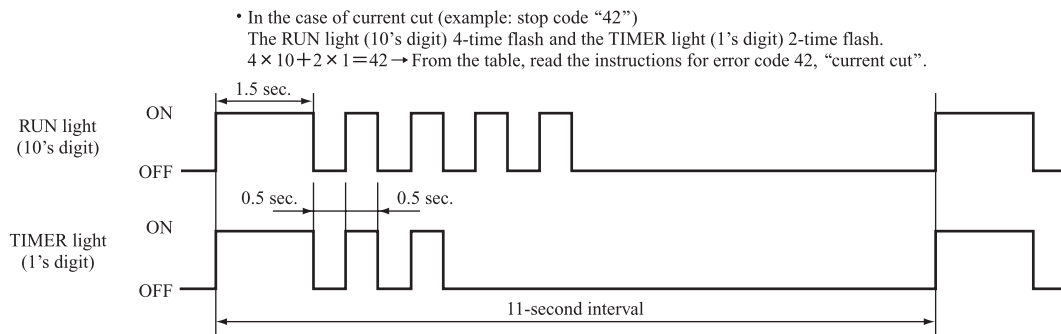

\*4: When in the service mode, when the wireless remote control settings (operation mode, fan speed mode, temperature setting) are set as shown in the following table and sent to the air-conditioner unit, the unit switches to display of service data.

**(i) Self-diagnosis data**

What are Self-diagnosis Data?

These are control data (reasons for stops, temperature at each sensor, wireless remote control information) from the time when there were error displays (abnormal stops) in the indoor unit in the past. Data from up to 5 previous occasions are stored in memory. Data older than the 5th previous occasion are erased. The temperature setting indicates how many occasions previous to the present setting the error display data are and the operation mode and fan speed mode data show the type of data.

Wireless remote control setting		Contents of output data
Operation mode	Fan speed mode	
Cooling	MED	Displays the reason for stopping display in the past (error code).
	HI	Displays the room temperature sensor temperature at the time the error code was displayed in the past.
	AUTO	Displays the indoor heat exchanger temperature sensor temperature at the time the error code was displayed in the past.
Heating	LO	Displays the wireless remote control information at the time the error code was displayed in the past.
	MED	Displays the outdoor air temperature sensor temperature at the time the error code was displayed in the past.
	HI	Displays the outdoor heat exchanger temperature sensor temperature at the time the error code was displayed in the past.
	AUTO	Displays the discharge pipe temperature sensor temperature at the time the error code was displayed in the past.

Wireless remote control setting	Indicates the number of occasions previous to the present the error display data are from.
Temperature setting	
21°C	1 time previous (previous time)
22°C	2 times previous
23°C	3 times previous
24°C	4 times previous
25°C	5 times previous

**Only for indoor heat exchanger temperature sensor 2**

Wireless remote control setting	Indicates the number of occasions previous to the present the error display data are from.
Temperature setting	
26°C	1 time previous (previous time)
27°C	2 times previous
28°C	3 times previous
29°C	4 times previous
30°C	5 times previous

(Example)

Wireless remote control setting			Displayed data
Operation mode	Fan speed mode	Temperature setting	
Cooling	MED	21°C	Displays the reason for the stop (error code) the previous time an error was displayed.
		22°C	Displays the reason for the stop (error code) 2 times previous when an error was displayed.
		23°C	Displays the reason for the stop (error code) 3 times previous when an error was displayed.
		24°C	Displays the reason for the stop (error code) 4 times previous when an error was displayed.
		25°C	Displays the reason for the stop (error code) 5 times previous when an error was displayed.

(ii) Stop data

Wireless remote control setting			Displayed data
Operation mode	Fan speed mode	Temperature setting	
Cooling	LO	21°C	Displays the reason for the stop (stop code) the previous time when the air-conditioner was stopped by protective stop control.
		22°C	Displays the reason for the stop (stop code) 2 times previous when the air-conditioner was stopped by protective stop control.
		23°C	Displays the reason for the stop (stop code) 3 times previous when the air-conditioner was stopped by protective stop control.
		24°C	Displays the reason for the stop (stop code) 4 times previous when the air-conditioner was stopped by protective stop control.
		25°C	Displays the reason for the stop (stop code) 5 times previous when the air-conditioner was stopped by protective stop control.
		26°C	Displays the reason for the stop (stop code) 6 times previous when the air-conditioner was stopped by protective stop control.
		27°C	Displays the reason for the stop (stop code) 7 times previous when the air-conditioner was stopped by protective stop control.
		28°C	Displays the reason for the stop (stop code) 8 times previous when the air-conditioner was stopped by protective stop control.
		29°C	Displays the reason for the stop (stop code) 9 times previous when the air-conditioner was stopped by protective stop control.
		30°C	Displays the reason for the stop (stop code) 10 times previous when the air-conditioner was stopped by protective stop control.



(c) **Error code, stop code table** (Assignment of error codes and stop codes is done in common for all models.)

Number of flashes when in service mode		Stop code or Error code	Error content	Cause	Occurrence conditions	Error display	Auto recovery
RUN light (10's digit)	TIMER light (1's digit)						
OFF	OFF	0	Normal	—	—	—	—
	1-time flash	01	Error of wired remote control wiring (When wired remote control was connected) (When wireless LAN interface was connected, refer to page 23.)	Broken wired remote control wire defective indoor unit PCB.	The wired remote control wire Y is open. The wired remote control wires X and Y are reversely connected. Noise is penetrating the wired remote control lines. The wired remote control or indoor unit PCB is faulty.	—	○
	5-time flash	05	Can not receive signals for 35 seconds (if communications have recovered)	Power source is faulty Power source cables and signal lines are improperly wired. Indoor or outdoor unit PCB are faulty	When 35 seconds passes without communications signals from either the outdoor unit or the indoor unit being detected correctly.	○	—
3-time flash	5-time flash	35	Cooling high pressure control	Cooling overload operation. Outdoor unit fan speed drops. Outdoor heat exchanger temperature sensor is short-circuit.	When the outdoor heat exchanger temperature sensor's value exceeds the set value.	○ (5 times)	○
	6-time flash	36	Compressor overheat 110°C	Refrigerant is insufficient. Discharge pipe temperature sensor is faulty. Service valve is closed.	When the discharge pipe temperature sensor's value exceeds the set value.	○ (2 times)	○
	7-time flash	37	Outdoor heat exchanger temperature sensor is abnormal	Outdoor heat exchanger temperature sensor wire is disconnected. Connector connections are poor. Outdoor unit PCB is faulty	-55°C or lower is detected for 5 seconds continuously 3 times within 40 minutes after initial detection of this anomalous temperature. Or -55°C higher is detected for 5 seconds continuously within 20 seconds after power ON.	○ (3 times)	○
	8-time flash	38	Outdoor air temperature sensor is abnormal	Outdoor air temperature sensor wire is disconnected. Connector connections are poor. Outdoor unit PCB is faulty	-55°C or lower is detected for 5 seconds continuously 3 times within 40 minutes after initial detection of this anomalous temperature. Or -55°C higher is detected for 5 seconds continuously within 20 seconds after power ON.	○ (3 times)	○
	9-time flash	39	Discharge pipe temperature sensor is abnormal (anomalous stop)	Discharge pipe temperature sensor wire is disconnected. Connector connections are poor. Outdoor unit PCB is faulty	-25°C or lower is detected for 5 seconds continuously 3 times within 40 minutes after initial detection of this anomalous temperature.	○ (3 times)	○
4-time flash	OFF	40	Service valve (gas side) closed operation	Service valve (gas side) closed Outdoor unit PCB is faulty.	If the inverter output current value exceeds the setting value within 80 seconds after the compressor ON in the heating mode, the compressor stops.	○ (2 times)	○
	2-time flash	42	Current cut	Compressor lock. Compressor wiring short circuit. Compressor output is open phase. Outdoor unit PCB is faulty Service valve is closed. Electronic expansion valve is faulty. Compressor is faulty.	Compressor start fails 42 times in succession and the reason for the final failure is current cut.	○ (2 times)	○
	7-time flash	47	Active filter voltage error	Defective active filter	When the wrong voltage connected for the power source. When the outdoor unit PCB is faulty.	○	—
	8-time flash	48	Outdoor fan motor is abnormal	Outdoor fan motor is faulty. Connector connections are poor. Outdoor unit PCB is faulty	When a fan speed of 75 min <sup>-1</sup> or lower continues for 30 seconds or longer.	○ (3 times)	○
5-time flash	1-time flash	51	Short-circuit in the power transistor (high side) Current cut circuit breakdown	Outdoor unit PCB is faulty Power transistor is damaged.	When it is judged that the power transistor was damaged at the time the compressor started.	○	—
	7-time flash	57	Refrigeration cycle system protective control	Service valve is closed. Refrigerant is insufficient.	When refrigeration cycle system protective control operates.	○ (3 times)	○
	8-time flash	58	Current safe	Refrigerant is overcharge. Compressor lock. Overload operation.	When there is a current safe stop during operation.	—	○
	9-time flash	59	Compressor wiring is unconnection Voltage drop Low speed protective control	Compressor wiring is disconnected. Power transistor is damaged. Power source construction is defective. Outdoor unit PCB is faulty Compressor is faulty.	When the current is 1A or less at the time the compressor started. When the power source voltage drops during operation. When the compressor command speed is 1ower than 32 rps for 60 minutes.	○	○
6-time flash	OFF	60	Rotor lock	Compressor is faulty. Compressor output is open phase. Electronic expansion valve is faulty. Overload operation. Outdoor unit PCB is faulty	After the compressor starts, when the compressor stops due to rotor lock.	○ (2 times)	○
	1-time flash	61	Connection lines between the indoor and outdoor units are faulty	Connection lines are faulty. Indoor or outdoor unit PCB are faulty	When 10 seconds passes after the power is turned on without communications signals from the indoor or outdoor unit being detected correctly.	○	—
	2-time flash	62	Serial transmission error	Indoor or outdoor unit PCB are faulty Noise is causing faulty operation.	When 7 minute 35 seconds passes without communications signals from either the outdoor unit or the indoor unit being detected correctly.	○	—
8-time flash	OFF	80	Indoor fan motor is abnormal	Indoor fan motor is faulty. Connector connections are poor. Indoor unit PCB is faulty	When the indoor fan motor is detected to be running at 300min <sup>-1</sup> or lower speed with the fan motor in the ON condition while the air-conditioner is running.	○	—
	2-time flash	82	Indoor heat exchanger temperature sensor is abnormal (anomalous stop)	Indoor heat exchanger temperature sensor wire is disconnected. Connector connections are poor.	When a temperature of -28°C or lower is sensed continuously for 40 minutes during heating operation. (the compressor stops).	○	—
	4-time flash	84	Anti-condensation control	High humidity condition.	Anti-condensation prevention control is operating.	—	○
	5-time flash	85	Anti-frost control	Indoor fan speed drops. Indoor heat exchanger temperature sensor is broken wire.	When the anti-frost control operates and the compressor stops during cooling operation.	—	○
	6-time flash	86	Heating high pressure control	Heating overload operation. Indoor fan speed drops. Indoor heat exchanger temperature sensor is short-circuit.	When high pressure control operates during heating operation and the compressor stops.	—	○



Notes (1) The number of flashes when in the service mode do not include the 1.5 second period when the lights light up at first (start signal).  
(See the example shown below.)

• In the case of current cut (example: stop code “42”)  
The RUN light (10’s digit) 4-time flash and the TIMER light (1’s digit) 2-time flash.  
 $4 \times 10 + 2 \times 1 = 42$  → From the table, read the instructions for error code 42, “current cut”.

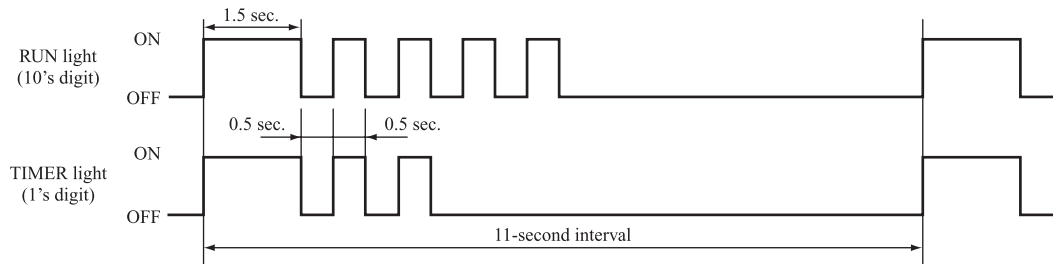

- (2) Error display:   
 — Is not displayed. (automatic recovery only)  
 Displayed.  
 If there is a ( ) displayed, the error display shows the number of times that an auto recovery occurred for the same reason has reached the number of times in ( ).  
 If no ( ) is displayed, the error display shows that the trouble has occurred once.
- (3) Auto Recovery:   
 — Does not occur  
 Auto recovery occurs.

**(d) Operation mode, Fan speed mode information tables**

(i) Operation mode

Display pattern when in service mode	Operation mode when there is an abnormal stop
<b>RUN light (10's digit)</b>	
—	AUTO
1-time flash	DRY
2-time flash	COOL
3-time flash	FAN
4-time flash	HEAT

(ii) Fan speed mode

Display pattern when in service mode	Fan speed mode when there is an abnormal stop
<b>TIMER light (1's digit)</b>	
—	AUTO
2-time flash	HI
3-time flash	MED
4-time flash	LO
5-time flash	ULO
6-time flash	HI POWER
7-time flash	ECONO

\* If no data are recorded (error code is normal), the information display in the operation mode and fan speed mode becomes as follows.

Mode	Display when error code is normal
<b>Operation mode</b>	AUTO
<b>Fan speed mode</b>	AUTO

(Example): Operation mode: COOL, Fan speed mode: HI

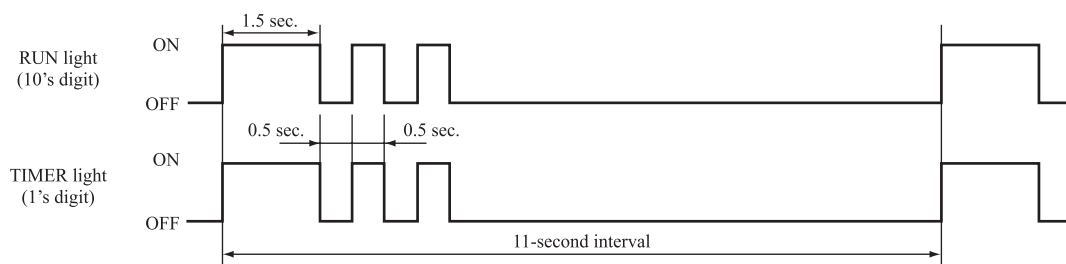

(e) Temperature information

(i) Room temperature sensor, indoor heat exchanger temperature sensor, outdoor air temperature sensor, outdoor heat exchanger temperature sensor

Unit: °C

Buzzer sound	TIMER light (1's digit)	RUN light (10's digit)									
		0	1	2	3	4	5	6	7	8	9
Yes (sounds for 0.1 second)	6	-60	-61	-62	-63	-64					
	5	-50	-51	-52	-53	-54	-55	-56	-57	-58	-59
	4	-40	-41	-42	-43	-44	-45	-46	-47	-48	-49
	3	-30	-31	-32	-33	-34	-35	-36	-37	-38	-39
	2	-20	-21	-22	-23	-24	-25	-26	-27	-28	-29
	1	-10	-11	-12	-13	-14	-15	-16	-17	-18	-19
	0	-	-1	-2	-3	-4	-5	-6	-7	-8	-9
No (does not sound)	0	0	1	2	3	4	5	6	7	8	9
	1	10	11	12	13	14	15	16	17	18	19
	2	20	21	22	23	24	25	26	27	28	29
	3	30	31	32	33	34	35	36	37	38	39
	4	40	41	42	43	44	45	46	47	48	49
	5	50	51	52	53	54	55	56	57	58	59
	6	60	61	62	63	64	65	66	67	68	69
	7	70	71	72	73	74	75	76	77	78	79
	8	80	81	82	83	84	85	86	87	88	89
	9	90	91	92	93	94	95	96	97	98	99

\* If no data are recorded (error code is normal), the display for each temperature information becomes as shown below.

Sensor name	Sensor value displayed when the error code is normal
Room temperature sensor	-64°C
Indoor heat exchanger temperature sensor	-64°C
Outdoor air temperature sensor	-64°C
Outdoor heat exchanger temperature sensor	-64°C

(Example) Outdoor heat exchanger temperature data: “-9°C”

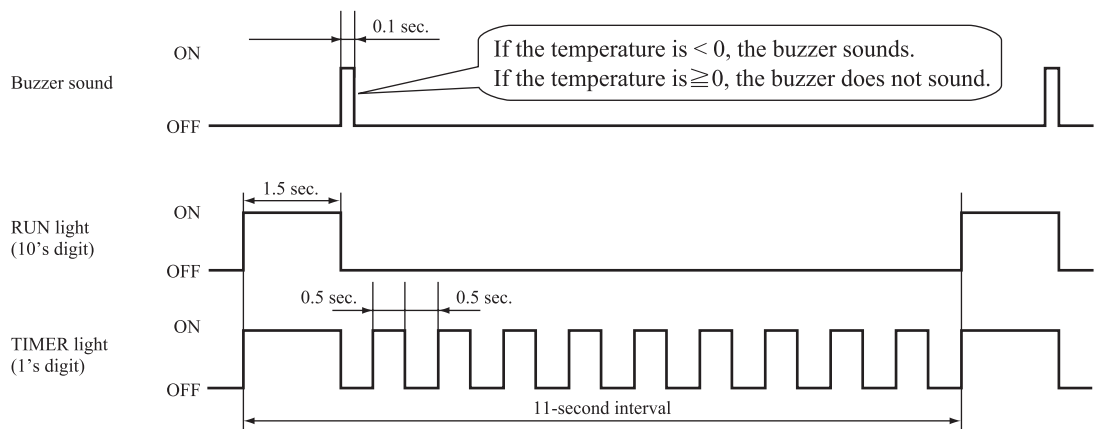

(ii) Discharge pipe temperature sensor

Unit: °C

Buzzer sound	TIMER light (1's digit)	RUN light (10's digit)									
			0	1	2	3	4	5	6	7	8
Yes (sounds for 0.1 second)	3	-60	-62	-64							
	2	-40	-42	-44	-46	-48	-50	-52	-54	-56	-58
	1	-20	-22	-24	-26	-28	-30	-32	-34	-36	-38
	0	/	-2	-4	-6	-8	-10	-12	-14	-16	-18
No (does not sound)	0	0	2	4	6	8	10	12	14	16	18
	1	20	22	24	26	28	30	32	34	36	38
	2	40	42	44	46	48	50	52	54	56	58
	3	60	62	64	66	68	70	72	74	76	78
	4	80	82	84	86	88	90	92	94	96	98
	5	100	102	104	106	108	110	112	114	116	118
	6	120	122	124	126	128	130	132	134	136	138
	7	140	142	144	146	148	150				

\* If no data are recorded (error code is normal), the display for each temperature information becomes as shown below.

Sensor name	Sensor value displayed when the error code is normal
Discharge pipe temperature sensor	-64°C

(Example) Discharge pipe temperature data: "122°C"

\* In the case of discharge pipe data, multiply the reading value by 2. (Below,  $61 \times 2 = "122°C"$ )

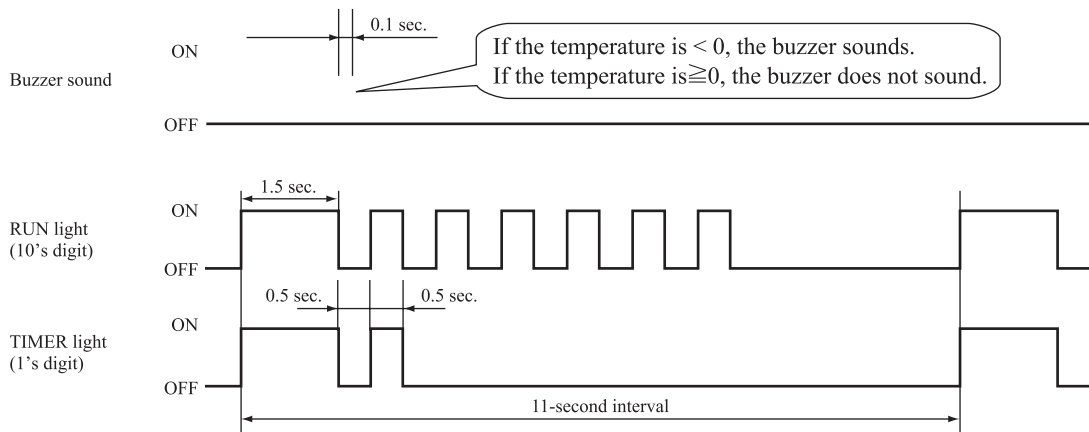

**Service data record form**

Customer		Model					
Date of investigation							
Machine name							
Content of complaint							
Wireless remote control settings			Content of displayed data	Display results			Display content
Temperature setting	Operation mode	Fan speed mode		Buzzer (Yes/No.)	RUN light (Times)	TIMER light (Times)	
21	Cooling	MED	Error code on previous occasion	/			
		HI	Room temperature sensor on previous occasion				
		AUTO	Indoor heat exchanger temperature sensor 1 on previous occasion				
	Heating	LO	Wireless remote control information on previous occasion	/			
		MED	Outdoor air temperature sensor on previous occasion				
		HI	Outdoor heat exchanger temperature sensor on previous occasion				
	AUTO	Discharge pipe temperature sensor on previous occasion					
26	Cooling	AUTO	Indoor heat exchanger temperature sensor 2 on previous occasion				
22	Cooling	MED	Error code on second previous occasion	/			
		HI	Room temperature sensor on second previous occasion				
		AUTO	Indoor heat exchanger temperature sensor 1 on second previous occasion				
	Heating	LO	Wireless remote control information on second previous occasion	/			
		MED	Outdoor air temperature sensor on second previous occasion				
		HI	Outdoor heat exchanger temperature sensor on second previous occasion				
	AUTO	Discharge pipe temperature sensor on second previous occasion					
27	Cooling	AUTO	Indoor heat exchanger temperature sensor 2 on second occasion				
23	Cooling	MED	Error code on third previous occasion	/			
		HI	Room temperature sensor on third previous occasion				
		AUTO	Indoor heat exchanger temperature sensor 1 on third previous occasion				
	Heating	LO	Wireless remote control information on third previous occasion	/			
		MED	Outdoor air temperature sensor on third previous occasion				
		HI	Outdoor heat exchanger temperature sensor on third previous occasion				
	AUTO	Discharge pipe temperature sensor on third previous occasion					
28	Cooling	AUTO	Indoor heat exchanger temperature sensor 2 on third occasion				
24	Cooling	MED	Error code on fourth previous occasion	/			
		HI	Room temperature sensor on fourth previous occasion				
		AUTO	Indoor heat exchanger temperature sensor 1 on fourth previous occasion				
	Heating	LO	Wireless remote control information on fourth previous occasion	/			
		MED	Outdoor air temperature sensor on fourth previous occasion				
		HI	Outdoor heat exchanger temperature sensor on fourth previous occasion				
	AUTO	Discharge pipe temperature sensor on fourth previous occasion					
29	Cooling	AUTO	Indoor heat exchanger temperature sensor 2 on fourth occasion				
25	Cooling	MED	Error code on fifth previous occasion	/			
		HI	Room temperature sensor on fifth previous occasion				
		AUTO	Indoor heat exchanger temperature sensor 1 on fifth previous occasion				
	Heating	LO	Wireless remote control information on fifth previous occasion	/			
		MED	Outdoor air temperature sensor on fifth previous occasion				
		HI	Outdoor heat exchanger temperature sensor on fifth previous occasion				
	AUTO	Discharge pipe temperature sensor on fifth previous occasion					
30	Cooling	AUTO	Indoor heat exchanger temperature sensor 2 on fifth occasion				
21	Cooling	LO	Stop code on previous occasion				
22			Stop code on second previous occasion				
23			Stop code on third previous occasion				
24			Stop code on fourth previous occasion				
25			Stop code on fifth previous occasion				
26			Stop code on sixth previous occasion				
27			Stop code on seventh previous occasion				
28			Stop code on eighth previous occasion				
29			Stop code on ninth previous occasion				
30			Stop code on tenth previous occasion				
Judgment							Examiner
Remarks							

Note (1) In the case of indoor heat exchanger temperature sensor 2, match from 26 to 30 the temperature setting of wireless remote control. (Refer to page 25.)

(7) Inspection procedures corresponding to detail of trouble

**Sensor error**

[Broken sensor wire, connector poor connection]

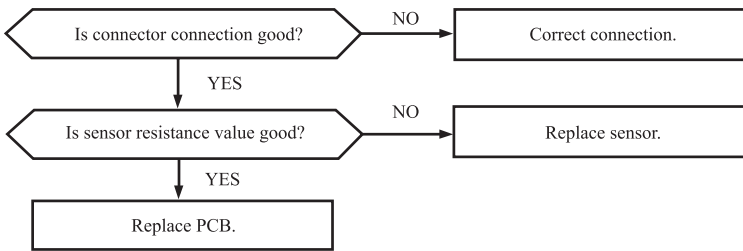

◆ Discharge pipe temperature sensor characteristics

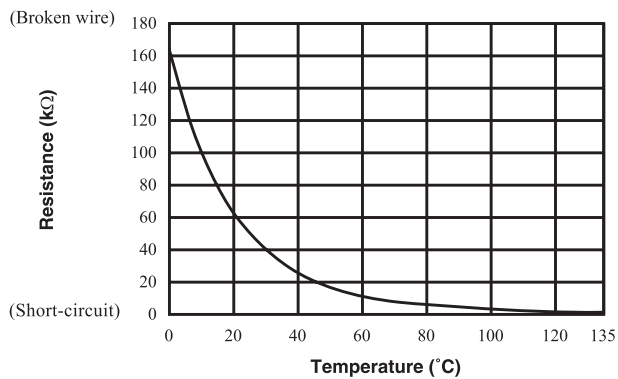

◆ Temperature sensor characteristics (Room air temperature, indoor heat exchanger temperature, outdoor heat exchanger temperature, outdoor air temperature)

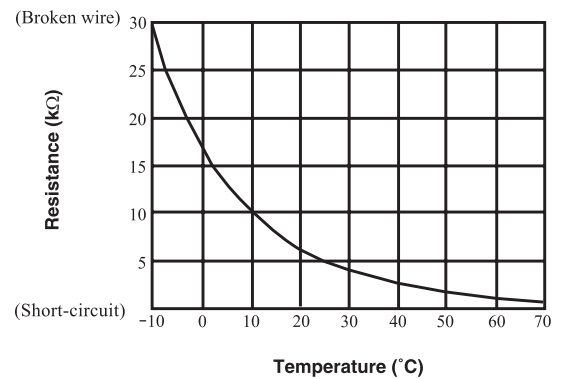

**Indoor fan motor error**

[Defective fan motor, connector poor connection, defective indoor unit PCB]

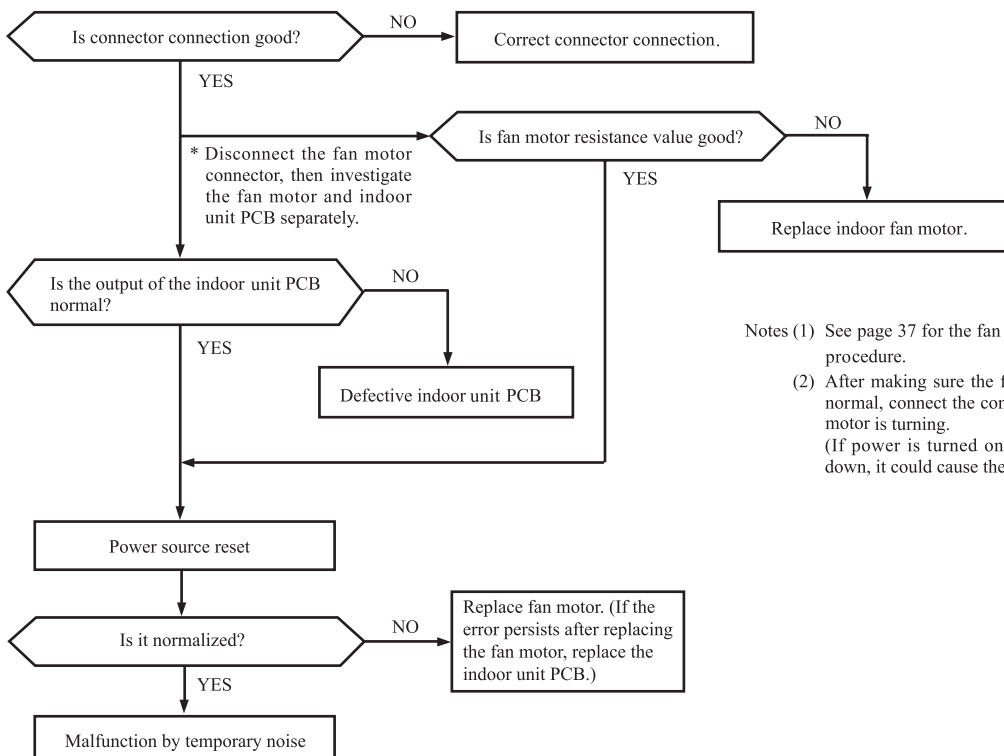

Notes (1) See page 37 for the fan motor and indoor unit PCB check procedure.  
 (2) After making sure the fan motor and indoor unit PCB are normal, connect the connectors and confirm that the fan motor is turning.  
 (If power is turned on while one or the other is broken down, it could cause the other to break down also.)

## Current cut

[Compressor lock, Compressor wiring short-circuit, Compressor output is open phase, Outdoor unit PCB is faulty, Service valve is closed, EEV is faulty, Compressor faulty.]

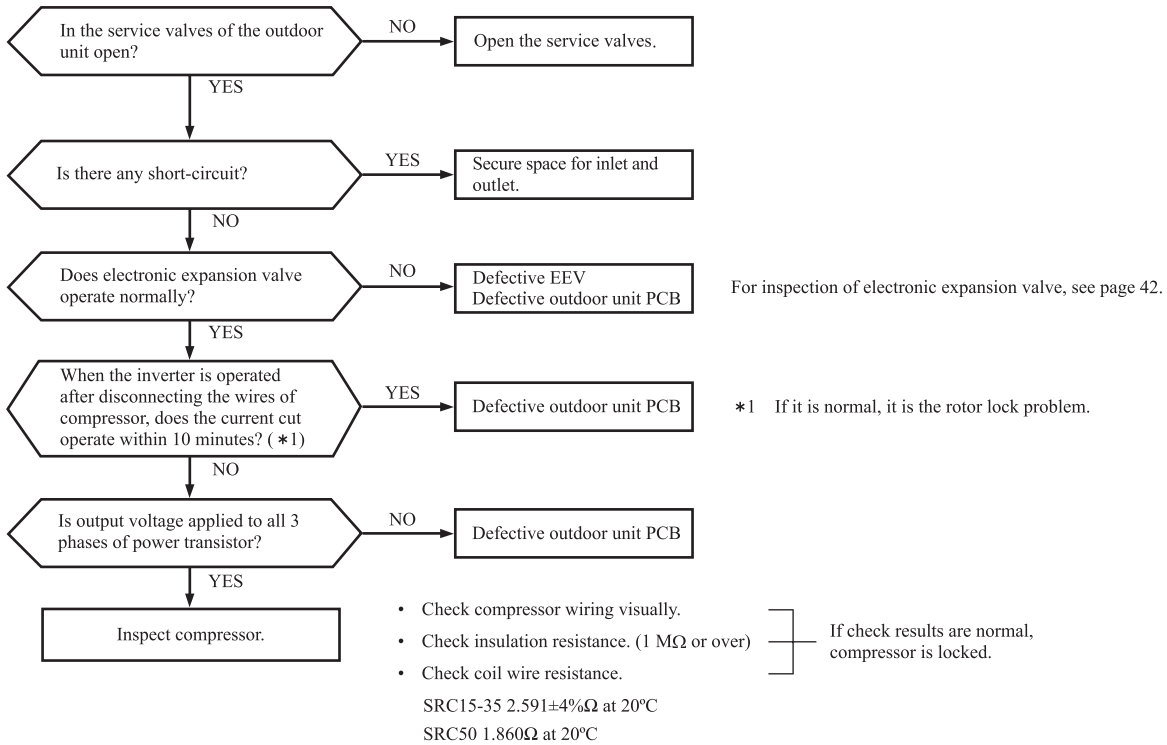

## Current safe stop

[Overload operation, compressor lock, overcharge]

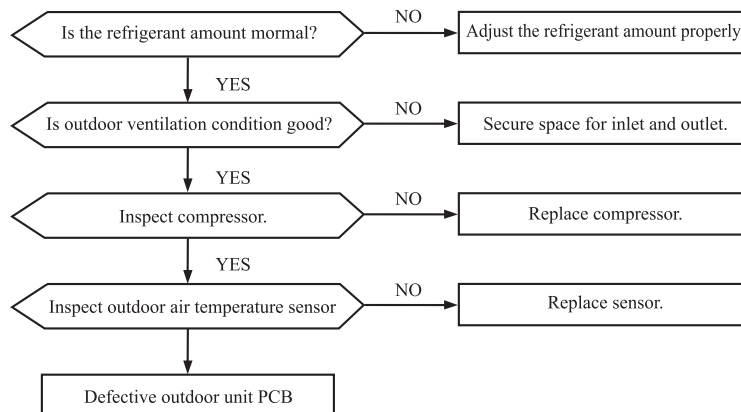

## Overheat of compressor

[ Gas shortage, defective discharge pipe temperature sensor ]

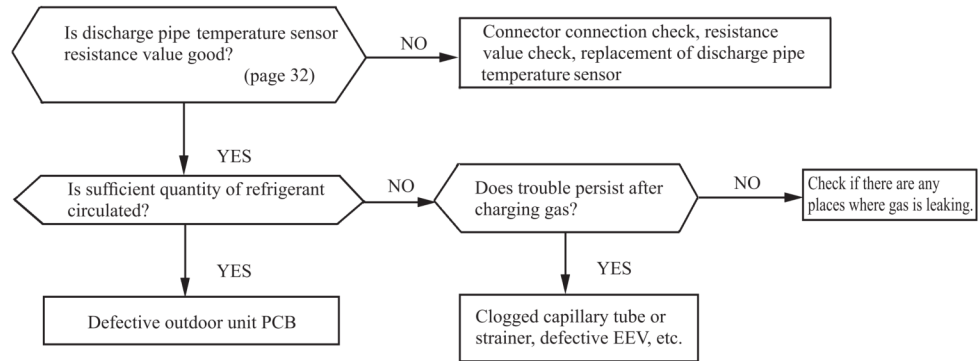

## Error of signal transmission

[ Wiring error including power cable, defective indoor/outdoor unit PCB ]

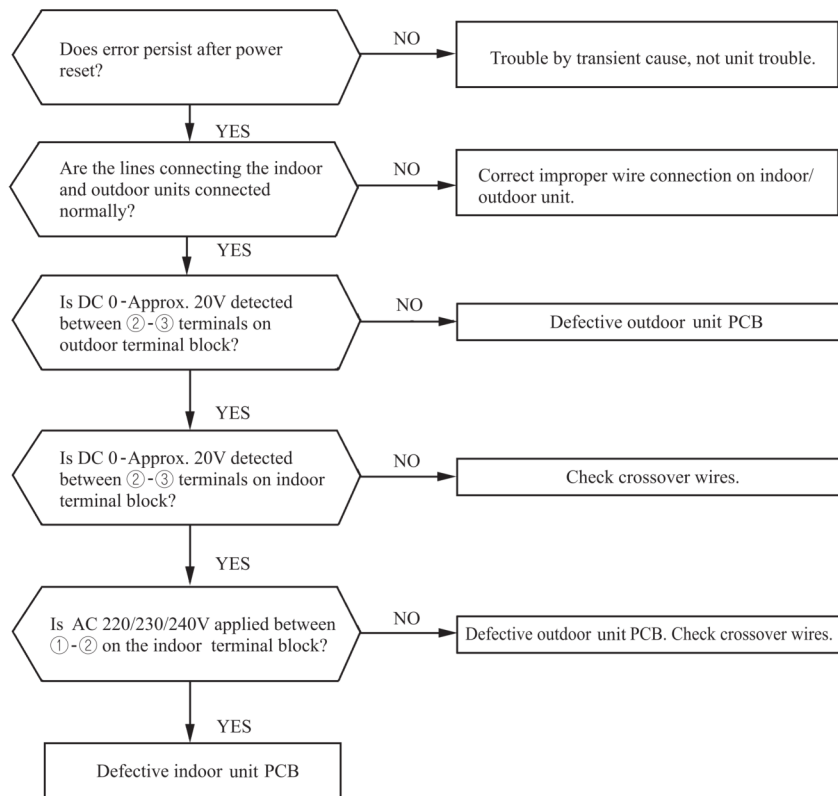

### Trouble of outdoor unit

[ Insufficient refrigerant amount, Faulty power transistor, Broken compressor wire ]  
 [ Service valve close, Defective EEV, Defective outdoor unit PCB ]

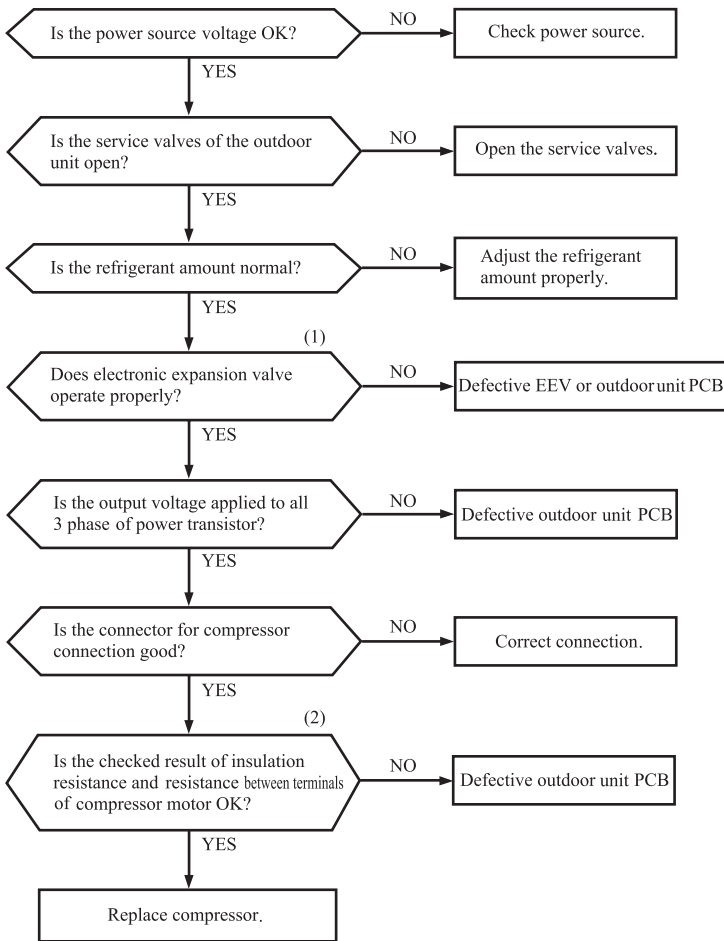

Proper power source voltages are as follows.  
 (At the power source outlet)  
 AC220V : AC 198-242V  
 AC230V : AC 207-253V  
 AC240V : AC 216-264V

- ◆ Judgment of refrigerant quantity
- (1) Phenomenon of insufficient refrigerant
    - (a) Loss of capacity
    - (b) Poor defrost operation  
(Frost is not removed completely.)
    - (c) Longer time of hot keep  
(5 minutes or more)  
(Normal time: Approx. 1 – 1 minute and 30 seconds)

Notes (1) For inspection of electronic expansion valve, see page 42.  
 (2) Check resistance between terminals, see page 33.

### Outdoor fan motor error

[ Defective fan motor, connector poor connection, defective outdoor unit PCB ]

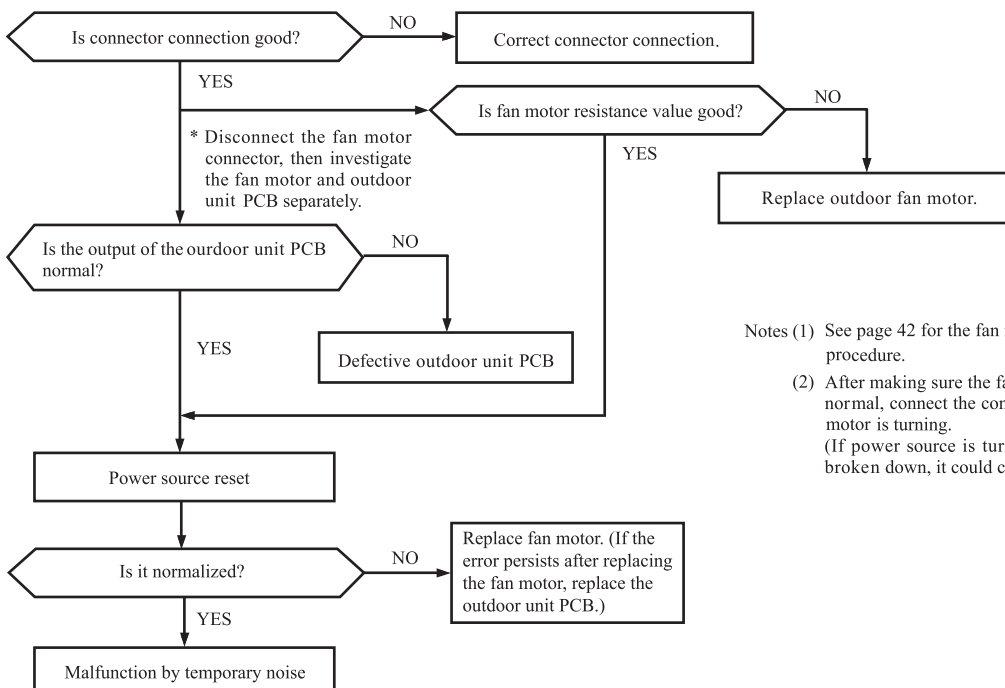

- Notes (1) See page 42 for the fan motor and outdoor unit PCB check procedure.  
 (2) After making sure the fan motor and outdoor unit PCB are normal, connect the connectors and confirm that the fan motor is turning.  
 (If power source is turned on while one or the other is broken down, it could cause the other to break down also.)



## Rotor lock

[ Defective compressor, defective outdoor unit PCB ]

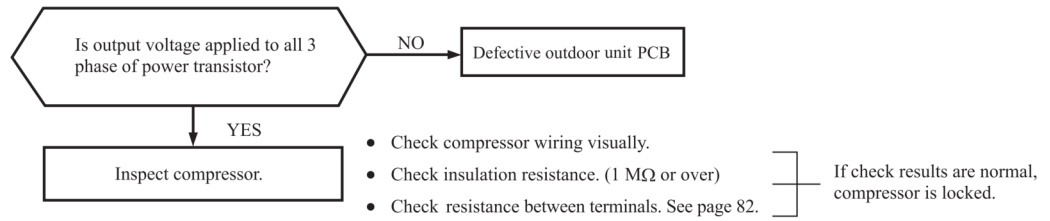

## Service valve (gas side) closed operation

[ Service valve (gas side) closed, Defective outdoor unit PCB ]

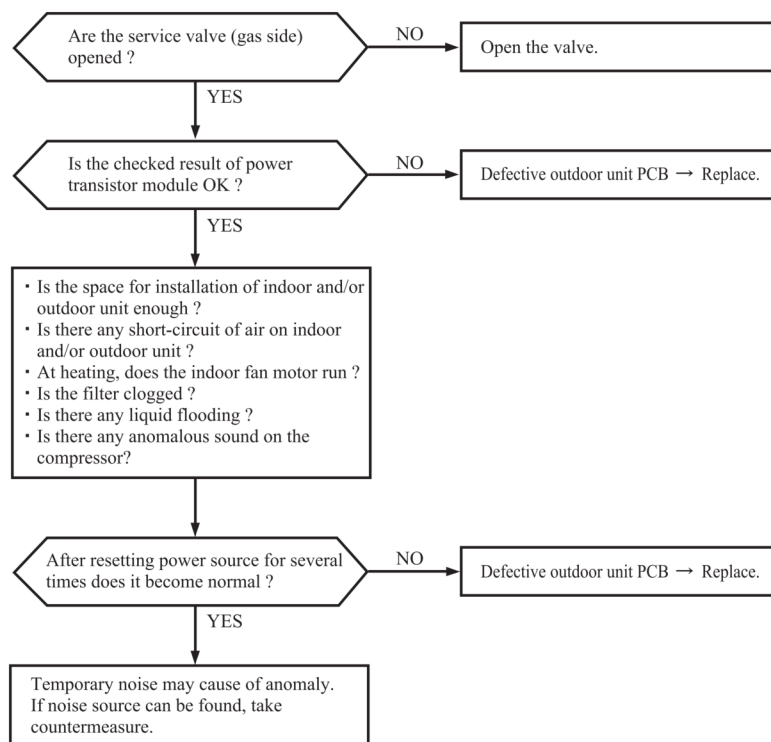

**(8) Phenomenon observed after short-circuit, wire breakage on sensor**

**(a) Indoor unit**

Sensor	Operation mode	Phenomenon	
		Short-circuit	Disconnected wire
Room air temperature sensor	Cooling	Release of continuous compressor operation command.	Continuous compressor operation command is not released.
	Heating	Continuous compressor operation command is not released.	Release of continuous compressor operation command.
Heat exchanger temperature sensor	Cooling	Freezing cycle system protection trips and stops the compressor.	Continuous compressor operation command is not released. (Anti-frosting)
	Heating	High pressure control mode (Compressor stop command)	Hot keep (Indoor fan stop)
Humidity sensor	Cooling	Refer to the table below.	Refer to the table below.
	Heating	Normal system operation is possible.	

**■ Humidity sensor operation**

Failure mode	Control input circuit reading	Air-conditioning system operation
Disconnected wire	① Disconnected wire	Humidity reading is 0%. Anti-condensation control is not done.
	② Disconnected wire	
	①② Disconnected wire	
Short-circuit	① and ② are short-circuited	Humidity reading is 100%. Anti-condensation control keep doing.

Remark: Do not perform a continuity check of the humidity sensor with a tester. If DC current is applied, it could damage the sensor.

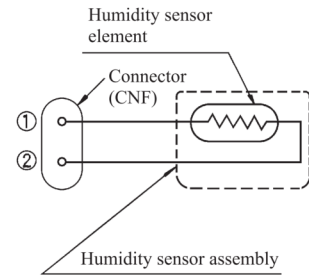

**(b) Outdoor unit**

Sensor	Operation mode	Phenomenon	
		Short-circuit	Disconnected wire
Heat exchanger temperature sensor	Cooling	Compressor stop.	Compressor stop.
	Heating	Defrost operation is not performed.	Defrost operation is performed for 10 minutes at approx. 35 minutes.
Outdoor air temperature sensor	Cooling	The compressor cannot pick up its speed owing to the current safe so that the designed capacity is not achieved.	Compressor stop.
	Heating	The compressor cannot pick up its speed owing to the heating overload protection so that the designed capacity is not achieved.	Defrost operation is performed for 10 minutes at approx. 35 minutes.
Discharge pipe temperature sensor	All modes	Compressor overload protection is disabled. (Can be operated.)	Compressor stop.

**(9) Checking the indoor electrical equipment**

**(a) Indoor unit PCB check procedure**

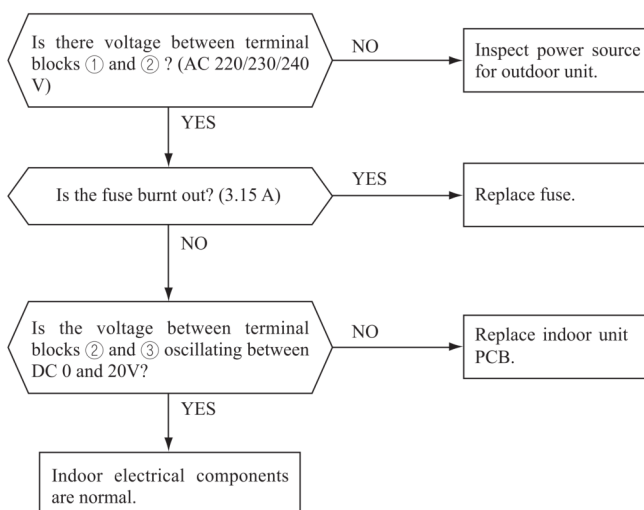

**(b) Indoor fan motor check procedure**

This is a diagnostic procedure for determining if the indoor fan motor or the indoor unit PCB is broken down.

**1) Indoor unit PCB output check**

- a) Turn off the power.
- b) Remove the front panel, then disconnect the fan motor lead wire connector.
- c) Turn on the power. If the unit operates when the ON/OFF button is pressed, if trouble is detected after the voltages in the following figure are output for approximately 30 seconds, it means that the indoor unit PCB is normal and the fan motor is broken down.

If the voltages in the following figure are not output at connector pins No. ①, ④ and ⑤, the indoor unit PCB has failed and the fan motor is normal.

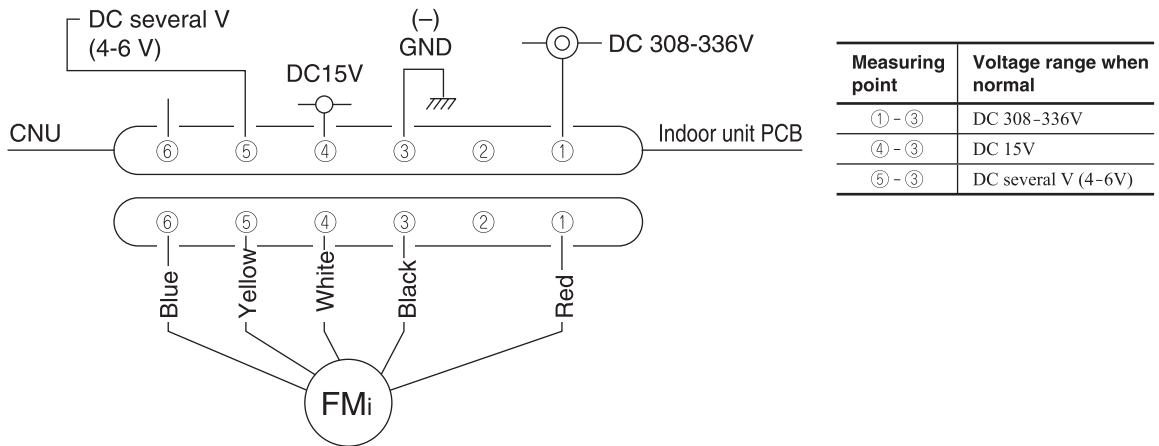

**2) Fan motor resistance check**

Measuring point	Resistance when normal
① - ③ (Red - Black)	20 MΩ or higher
④ - ③ (White - Black)	20 kΩ or higher

- Notes (1) Remove the fan motor and measure it without power connected to it.  
 (2) If the measured value is below the value when the motor is normal, it means that the fan motor is faulty.

**(10) How to make sure of wireless remote control**

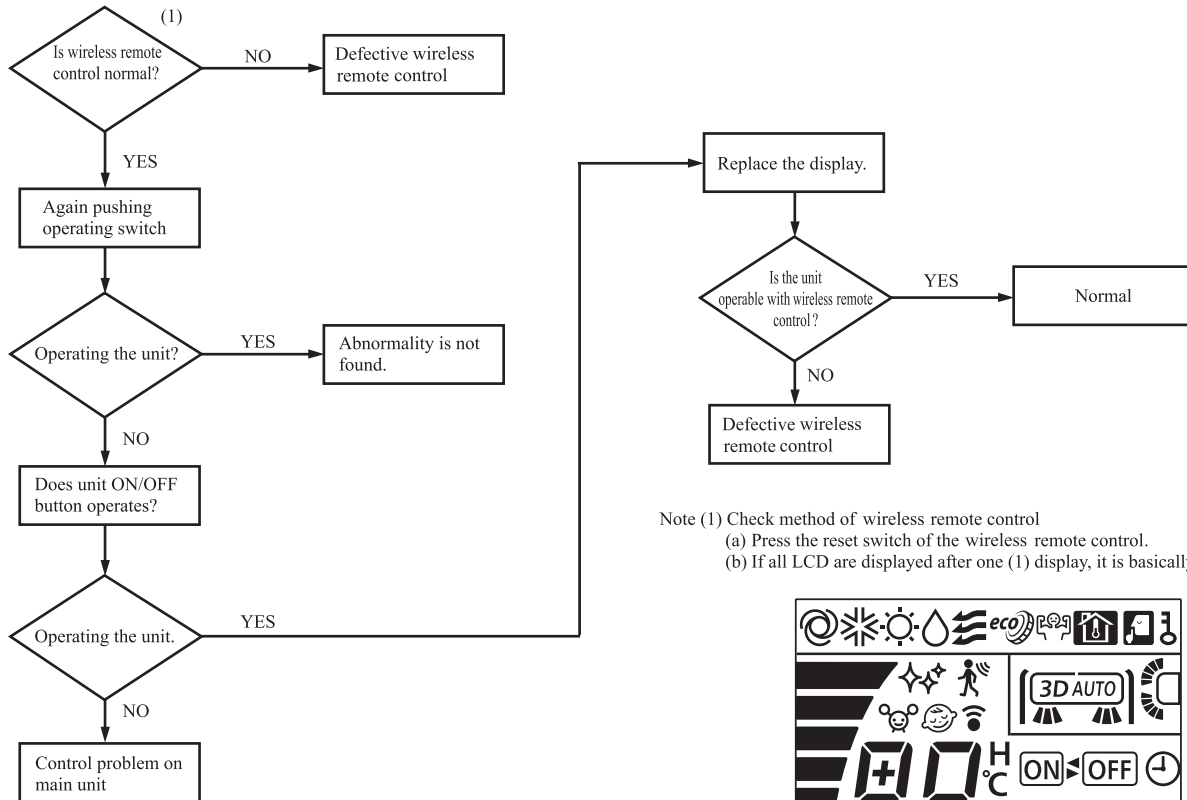

Note (1) Check method of wireless remote control  
 (a) Press the reset switch of the wireless remote control.  
 (b) If all LCD are displayed after one (1) display, it is basically normal.

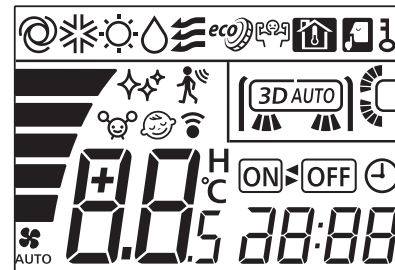

◆ Simplified check method of wireless remote control  
 It is normal if the signal transmission section of the wireless remote control emits a whitish light at each transmission on the monitor of digital camera.

**(11) Inspection procedure for blown fuse on the indoor and outdoor unit PCB**

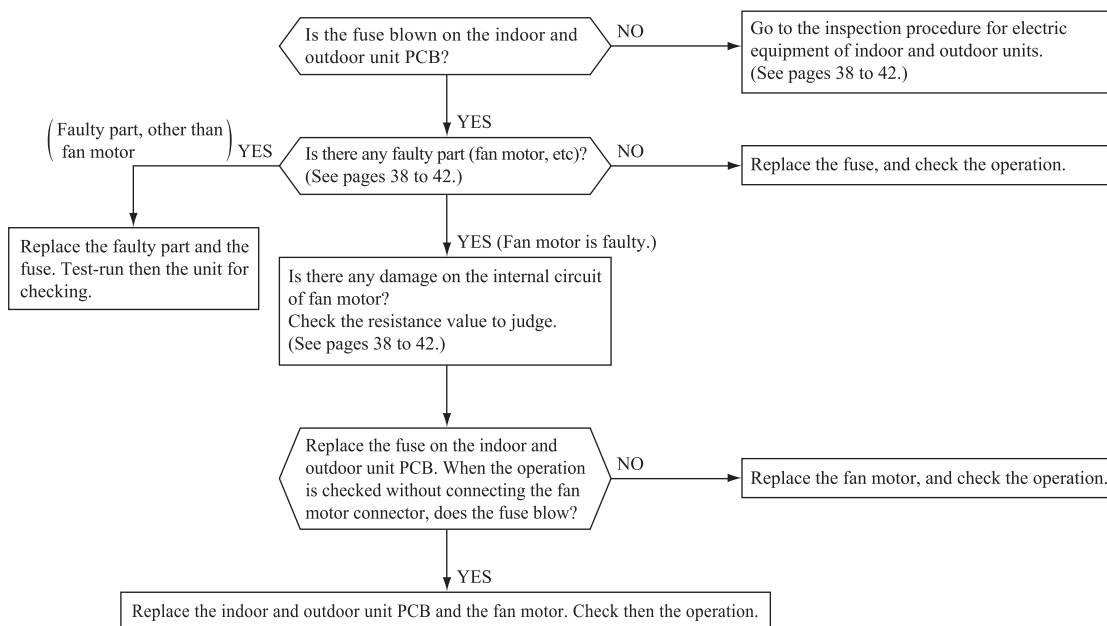

**(12) Outdoor unit inspection points**  
**Models SRC15ZTL-W, 20ZTL-W, 25ZTL-W, 35ZTL-W**

**◆ Check point of outdoor unit**

**⚠ WARNING – HIGH VOLTAGE**

High voltage is produced in the control box. Don't touch electrical parts in the control box for 5 minutes after the unit is stopped.

**◆ Power source and serial signal inspection**

- ① to ④ : AC 220/230/240V
- ① to ② : AC 220/230/240V
- ② to ③ : Normal if the voltage oscillates between DC 0 and approx. 20V

**Color symbol**

Mark	Color
BK	Black
BL	Blue
BR	Brown
OR	Orange
RD	Red
WH	White
YE	Yellow
YG	Yellow/Green

**◆ Voltage check in PCB**

The normal range is as follows.

- Display Voltage range
- ① DC280V DC230V - DC310V
  - ② DC 20V DC 18V - DC 22V
  - ③ DC 13V DC 12V - DC 14V
  - ④ DC 15V DC 14V - DC 16V
  - ⑤ DC 5V DC 4V - DC 6V
  - ⑥ DC 2.5V DC 2.3V - DC 2.5V

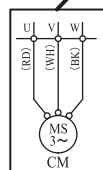
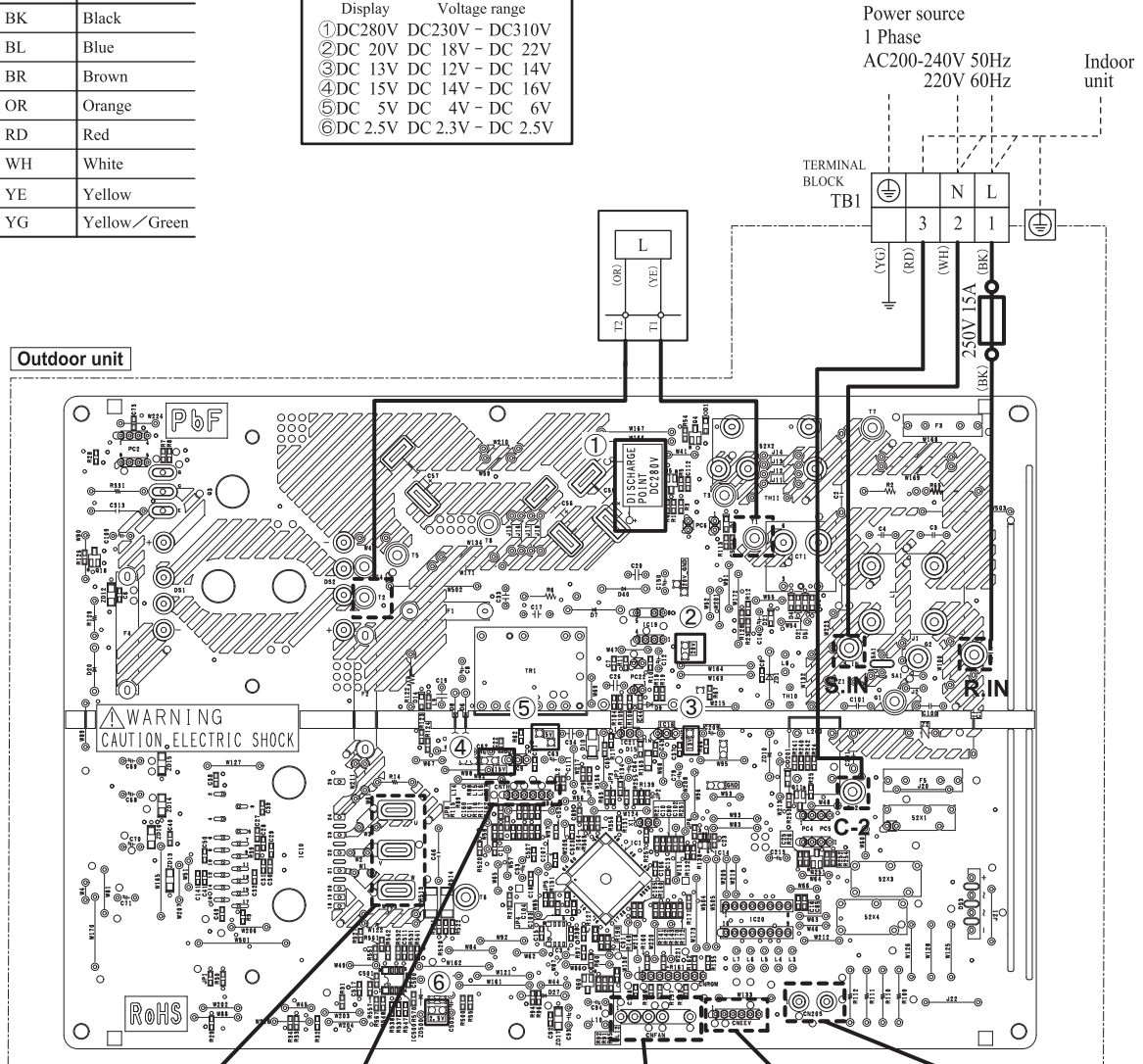

**◆ Inspection power transistor**  
 Remove the faston terminal and test output voltage

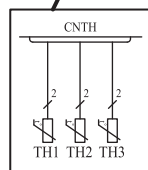

**◆ Inspection of resistance value of sensor**  
 Remove the connector and check the resistance value. See the section of sensor characteristics on page 32.

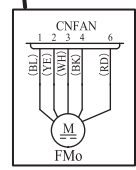

**◆ Inspection of outdoor fan motor**  
 See page 42.

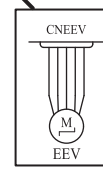

**◆ Inspection of electronic expansion valve**  
 See page 42.

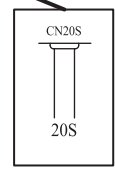

**Model SRC50ZTL-W**

**◆ Check point of outdoor unit**

**⚠ WARNING – HIGH VOLTAGE**

High voltage is produced in the control box. Don't touch electrical parts in the control box for 5 minutes after the unit is stopped.

**Color symbol**

Mark	Color
BK	Black
BL	Blue
RD	Red
WH	White
YE	Yellow
YG	Yellow/Green

**◆ Voltage check in PCB**

The normal range is as follows.

Display	Voltage range
① DC 280V	DC 230V – DC 310V
② DC 20V	DC 18V – DC 22V
③ DC 13V	DC 12V – DC 14V
④ DC 15V	DC 14V – DC 16V
⑤ DC 5V	DC 4V – DC 6V
⑥ DC 2.5V	DC 2.3V – DC 2.5V

**◆ Inspection power transistor**

Remove the faston terminal and test output voltage

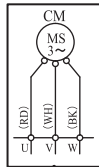

**◆ Power source and serial signal inspection**

- ① to ④ : AC 220/230/240V
- ① to ② : AC 220/230/240V
- ② to ③ : Normal if the voltage oscillates between DC 0 and approx. 20V

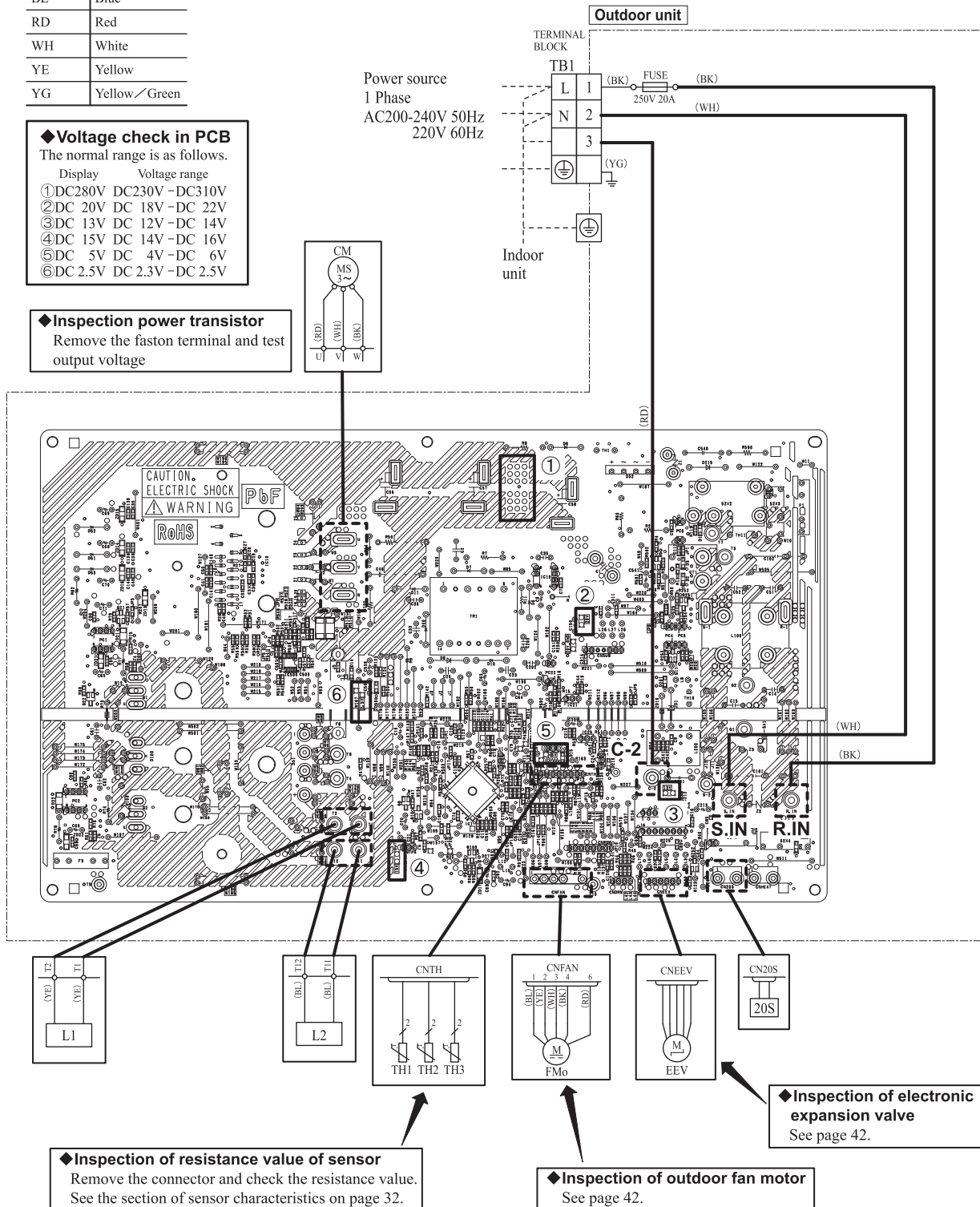

**◆ Inspection of resistance value of sensor**  
Remove the connector and check the resistance value. See the section of sensor characteristics on page 32.

**◆ Inspection of outdoor fan motor**  
See page 42.

**◆ Inspection of electronic expansion valve**  
See page 42.

**(a) Inspection of electronic expansion valve**

Electronic expansion valve operates for approx. 10 seconds after the power on, in order to determine its aperture. Check the operating sound and voltage during the period of time. (Voltage cannot be checked during operation in which only the aperture change occurs.)

- (i) If it is heard the sound of operating electronic expansion valve, it is almost normal.
- (ii) If the operating sound is not heard, check the output voltage.

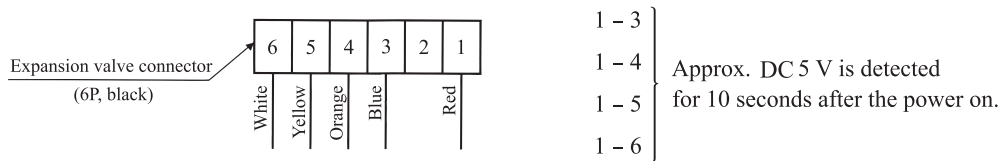

- (iii) If voltage is detected, the outdoor unit PCB is normal.
- (iv) If the expansion valve does not operate (no operating sound) while voltage is detected, the expansion valve is defective.

**• Inspection of electronic expansion valve as a separate unit**

Measure the resistance between terminals with an analog tester.

Measuring point	Resistance when normal
1-6	46 ± 4Ω (at 20°C)
1-5	
1-4	
1-3	

**(b) Outdoor fan motor check procedure**

- When the outdoor unit fan motor error is detected, diagnose which of the outdoor unit fan motor or outdoor unit PCB is defective.
- Diagnose this only after confirming that the indoor unit is normal.

(i) Outdoor unit PCB output check

- 1) Turn off the power.
- 2) Disconnect the outdoor fan motor connector CNFAN.
- 3) When the indoor unit is operated by inserting the power source plug and pressing (ON) the backup switch for more than 5 seconds, if the voltage of pin No. ② in the following figure is output for 30 seconds at 20 seconds after turning “ON” the backup switch, the outdoor unit PCB is normal but the fan motor is defective.

If the voltage is not detected, the outdoor unit PCB is defective but the fan motor is normal.

Note The voltage is output 3 times repeatedly. If it is not detected, the indoor unit displays the error message.

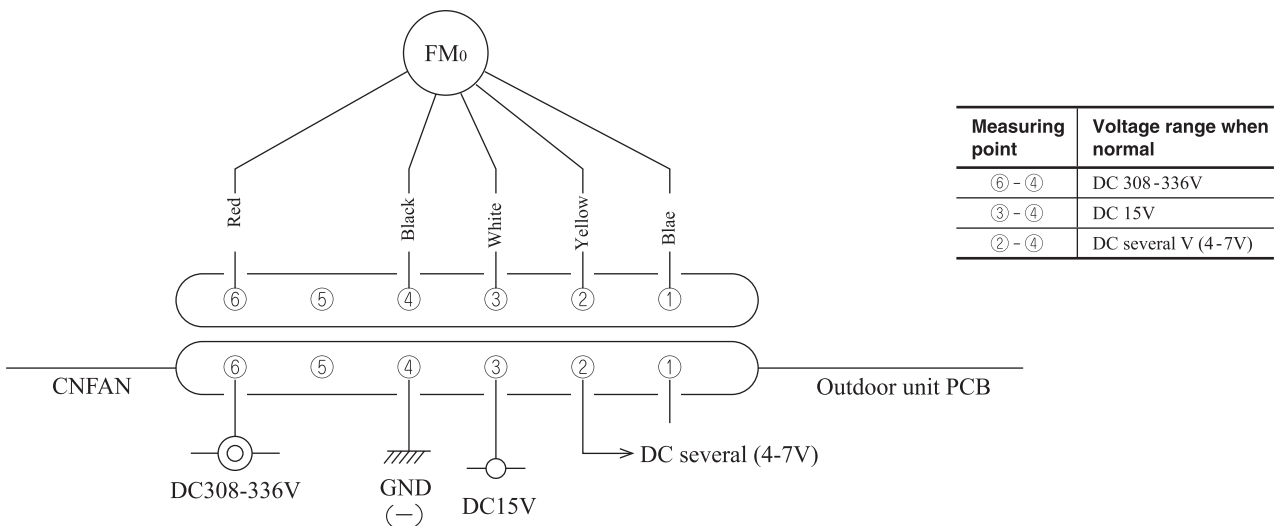

(ii) Fan motor resistance check

Measuring point	Resistance when normal
⑥ - ④ (Red - Black)	20 MΩ or higher
③ - ④ (White - Black)	20 kΩ or higher

- Notes (1) Remove the fan motor and measure it without power connected to it.
- (2) If the measured value is below the value when the motor is normal, it means that the fan motor is faulty.



### 3. ELECTRICAL WIRING

(1) Indoor units

Models SRK15ZTL-W, 20ZTL-W, 25ZTL-W, 35ZTL-W, 50ZTL-W

Item	Description
CNE	Connector
CNF	
CNG	
CNM	
CNS	
CNU	
CNX	
CNY	

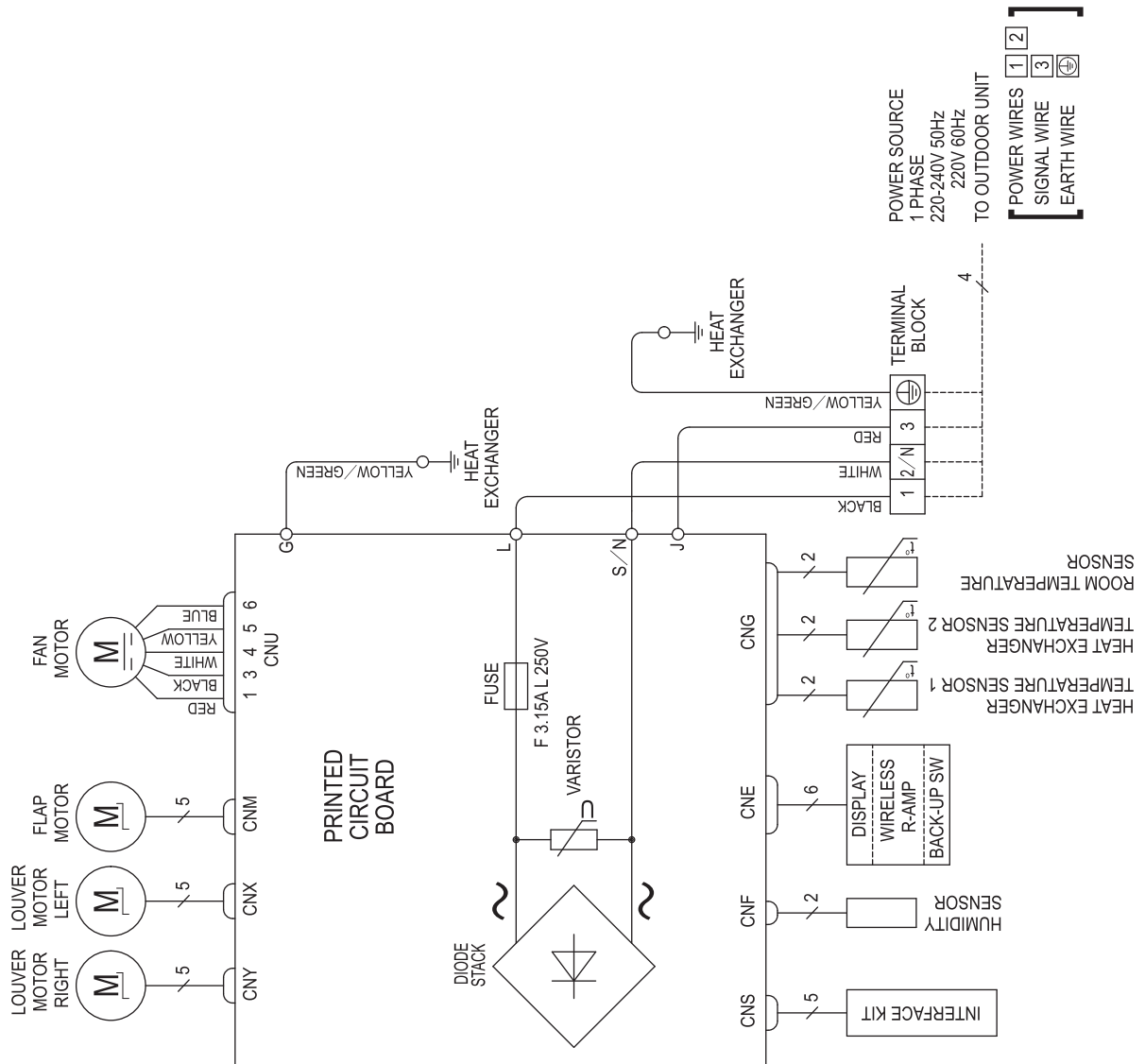

RWA000Z424



(2) Outdoor units

Models SRC15ZTL-W, 20ZTL-W, 25ZTL-W, 35ZTL-W

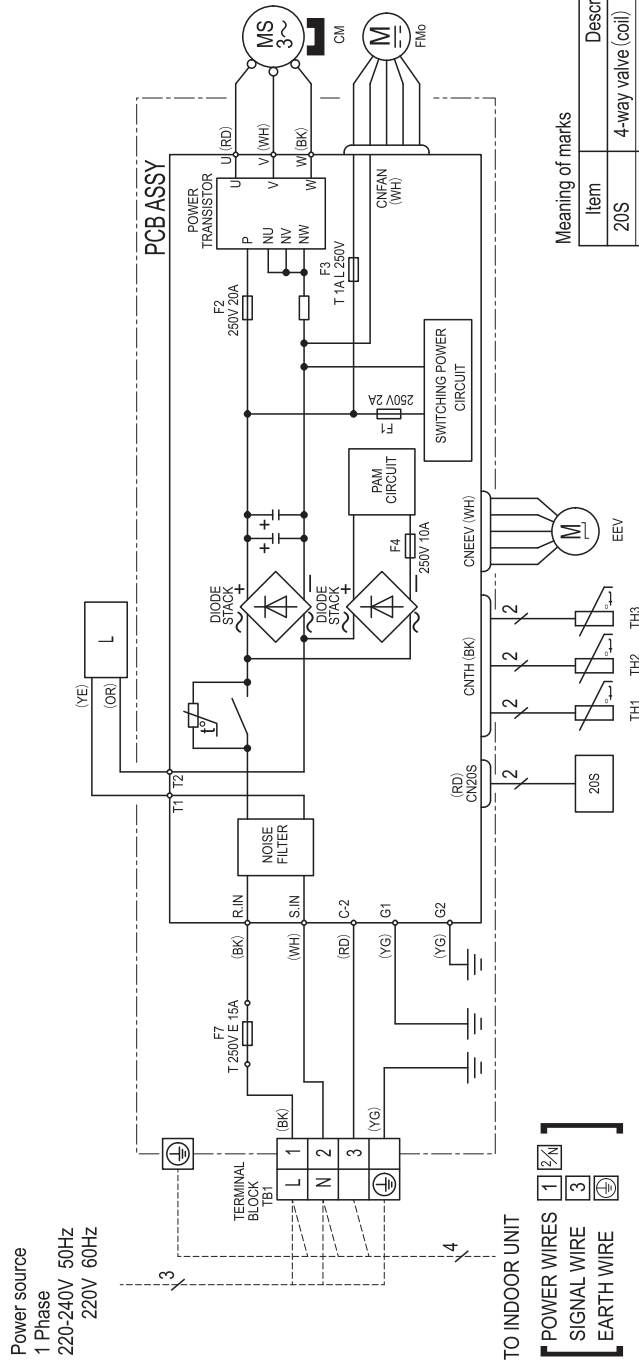

Color marks

Mark	Color
BK	Black
RD	Red
WH	White
OR	Orange
YE	Yellow
YG	Yellow / Green

Meaning of marks

Item	Description
20S	4-way valve (coil) Connector
CN20S	Connector
CNEEV	Compressor motor
CNFAN	Electric expansion valve (coil)
CNTH	Fan motor
CM	Reactor
EEV	Heat exchanger temperature sensor
FMo	Outdoor air temperature sensor
L	Discharge pipe temperature sensor
TH1	
TH2	
TH3	

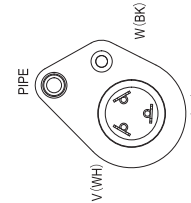

PIPE  
V (WH)  
U (RD)  
W (BK)  
COMPRESSOR  
TERMINAL BLOCK

Power cable, indoor-outdoor connecting wires

Model name	MAX running current (A)	Power cable wire size x number*	Power cable length (m)	Connecting cable wire size x number*
SRC15,20,25,35ZTL-W	9	2.5mm <sup>2</sup> x 3	28	1.5mm <sup>2</sup> x 4

- \* The wire numbers include Earth wire (Yellow / Green)
- Switchgear or circuit breaker capacity should be chosen according to national or regional electricity regulations.
- The power cable specifications are based on the assumption that a metal or plastic conduit is used with no more than three cables contained in a conduit and a voltage drop is 2%. For an installation falling outside of these conditions, please follow the national or regional electricity regulations.

Models SRC50ZTL-W

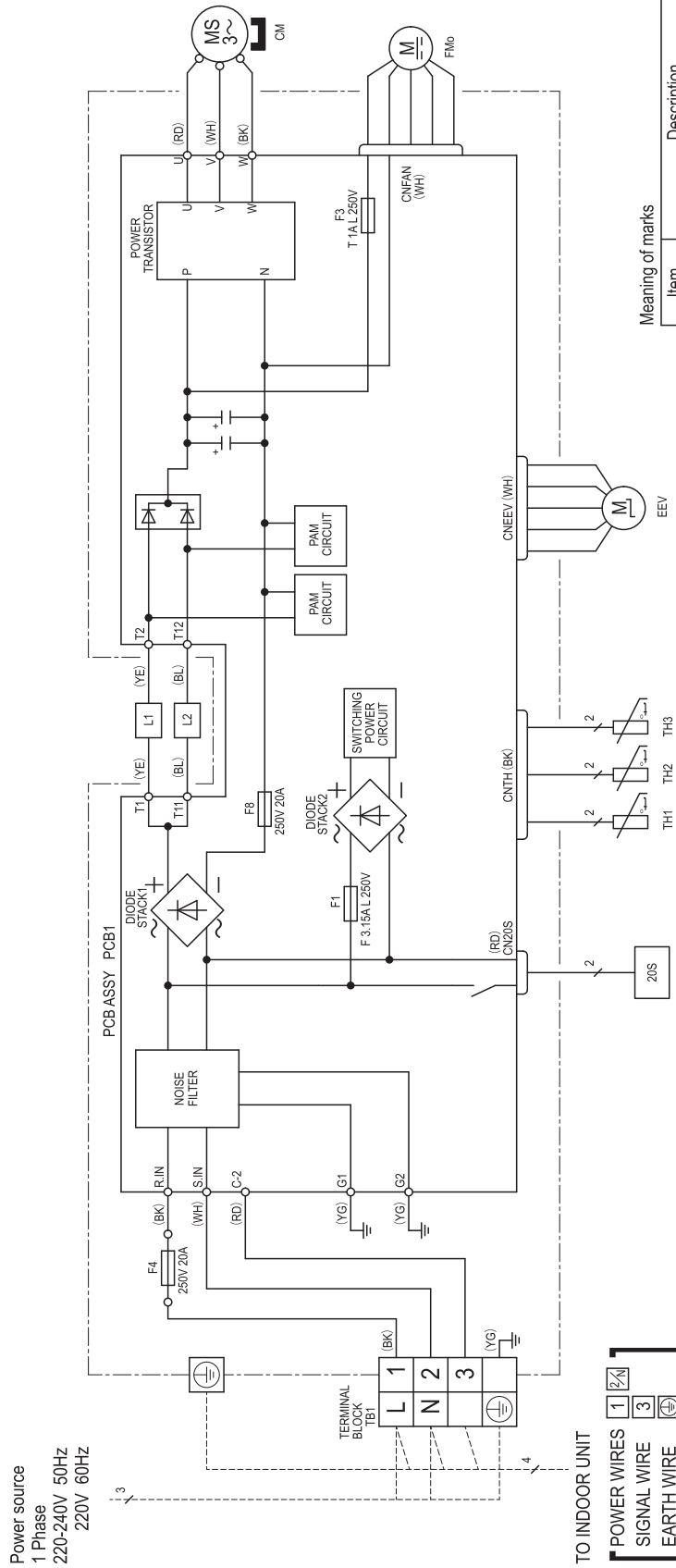

Power source  
1 Phase  
220-240V 50Hz  
220V 60Hz

TO INDOOR UNIT  
 [ POWER WIRES 1 2 3 ]  
 [ SIGNAL WIRE 3 ]  
 [ EARTH WIRE ]

Meaning of marks

Item	Description
20S	4-way valve (coil)
CN20S	Connector
CNEEV	Compressor motor
CNFAN	Electric expansion valve (coil)
CNTH	Fan motor
CM	Reactor
EEV	Heat exchanger temperature sensor
FMo	Outdoor air temperature sensor
L1,2	Discharge pipe temperature sensor
TH1	
TH2	
TH3	

Color marks

Mark	Color
BK	Black
BL	Blue
RD	Red
WH	White
YE	Yellow
YG	Yellow / Green

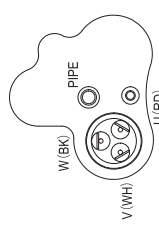

COMPRESSOR  
TERMINAL BLOCK

Power cable, indoor-outdoor connecting wires

Model name	MAX running current (A)	Power cable wire size x number*	Power cable length (m)	Connecting cable wire size x number*
SRC50ZTL-W	14.5	2.5mm <sup>2</sup> x 3	17	1.5mm <sup>2</sup> x 4

- \* The wire numbers include Earth wire (Yellow / Green)
- Switchgear or circuit breaker capacity should be chosen according to national or regional electricity regulations.
- The power cable specifications are based on the assumption that a metal or plastic conduit is used with no more than three cables contained in a conduit and a voltage drop is 2%. For an installation falling outside of these conditions, please follow the national or regional electricity regulations.

# 4. PIPING SYSTEM

Models SRK15ZTL-W, 20ZTL-W

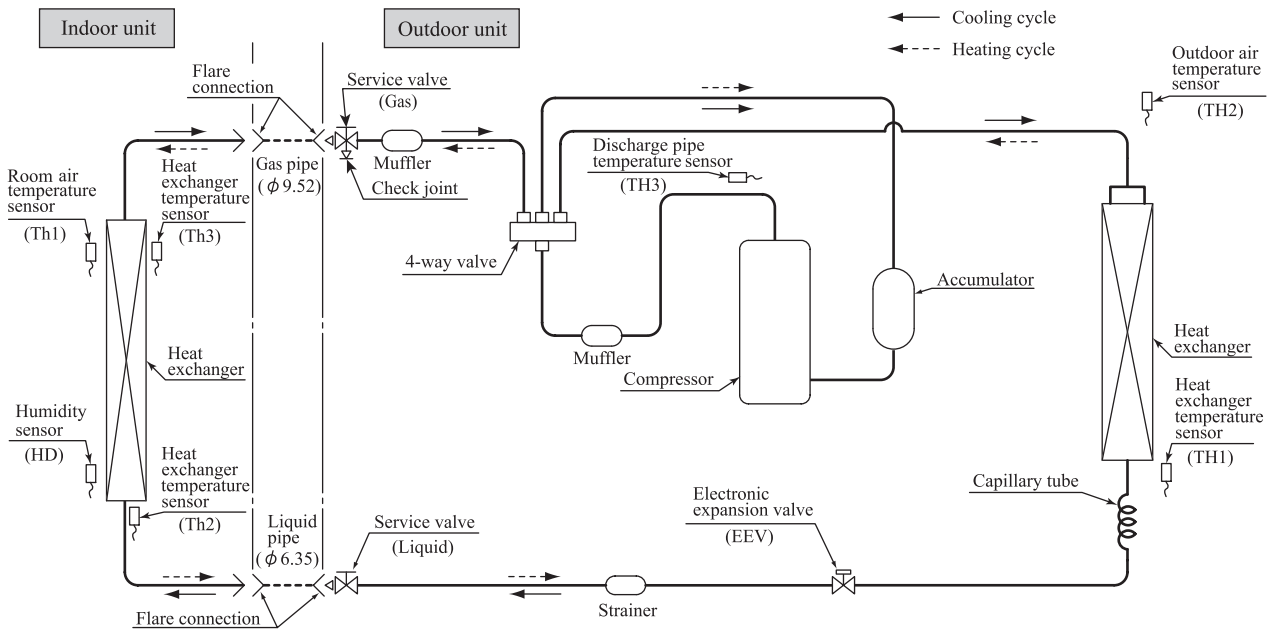

Models SRK25ZTL-W, 35ZTL-W

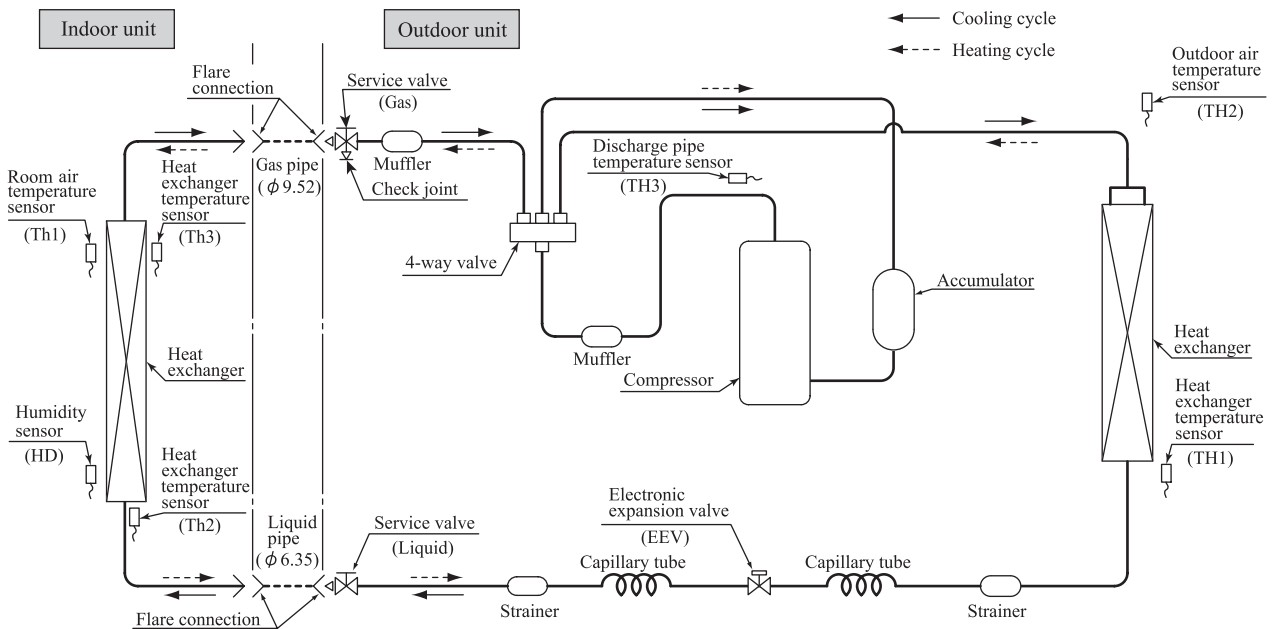

Model SRK50ZTL-W

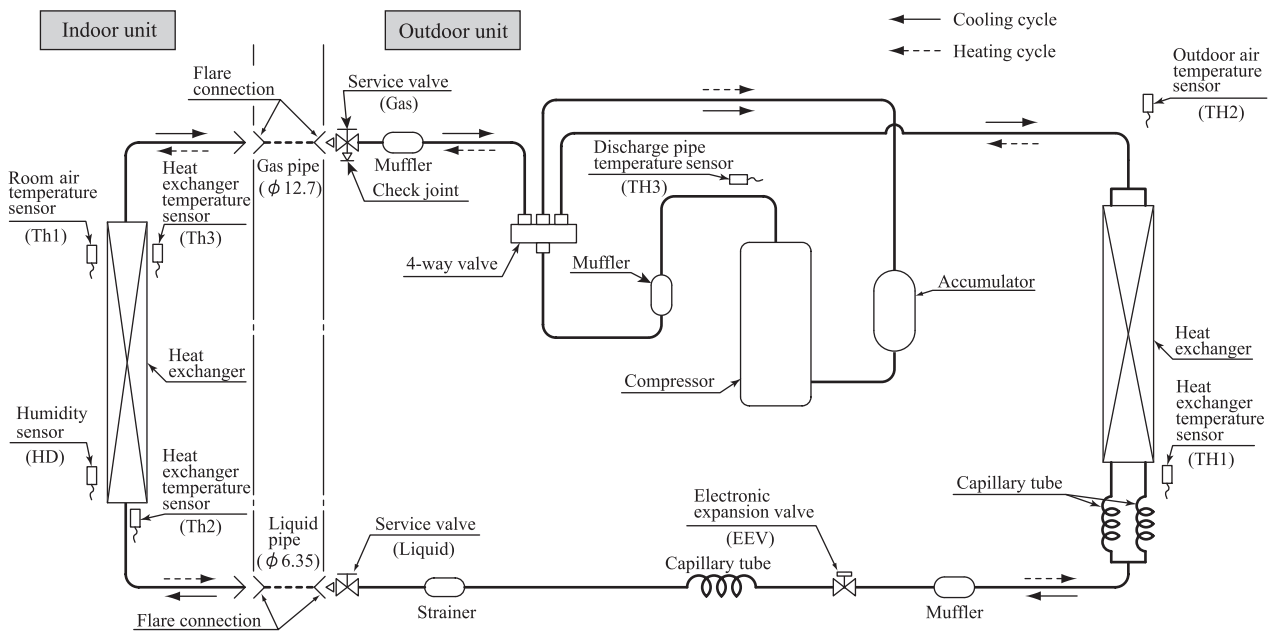

## 5. INDOOR UNIT DISASSEMBLY METHOD

(1) Remove the cover.

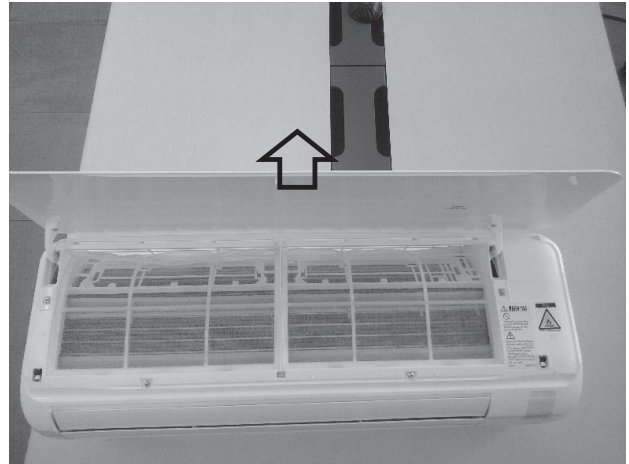

(2) Remove the screw (The following 2 places).



(3) Remove the end cover.

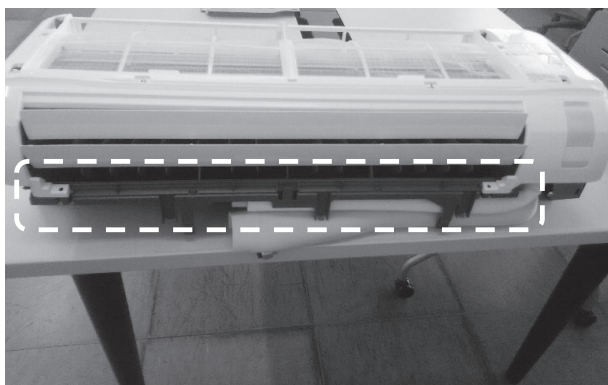

When removing the end cover,  
it is easier to remove it in the following order:  
center → left → right

(4) Remove nails (3 places).

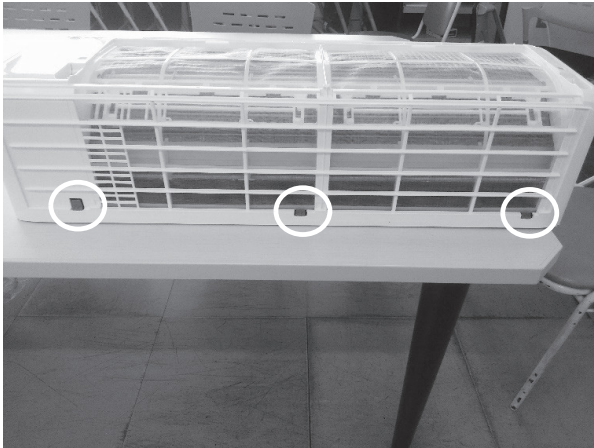

(5) Remove the cover.

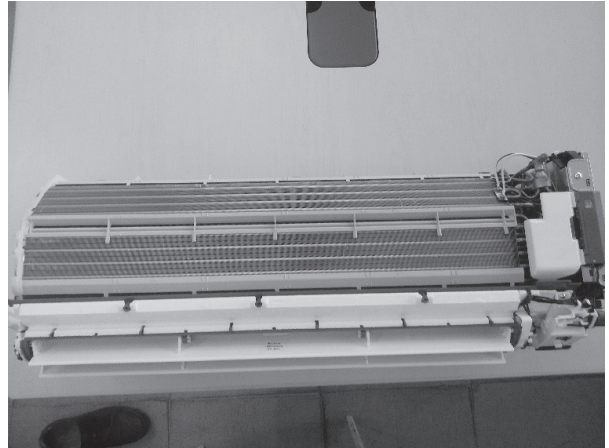

(6) Remove the control cover.

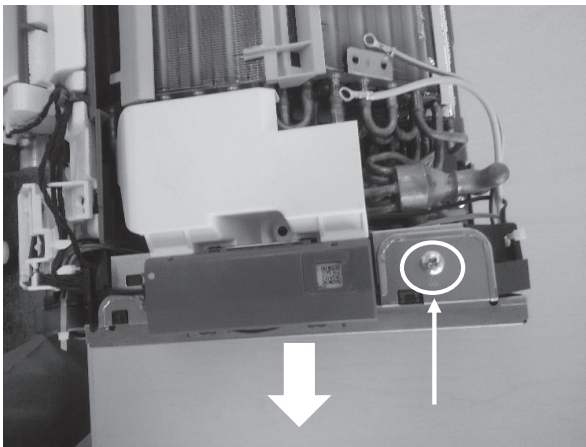

(7) Remove the screw (The following 3 places).

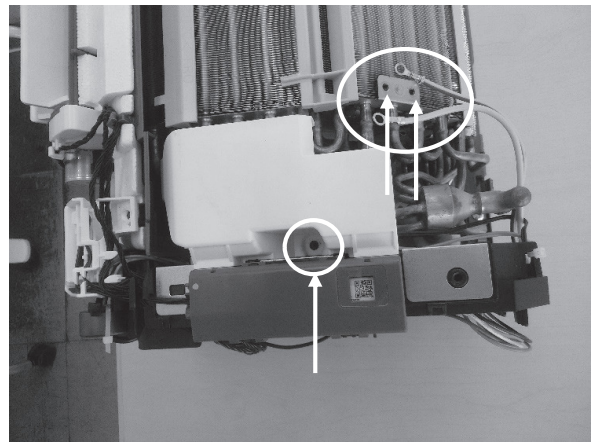

(8) Unplug the connector.

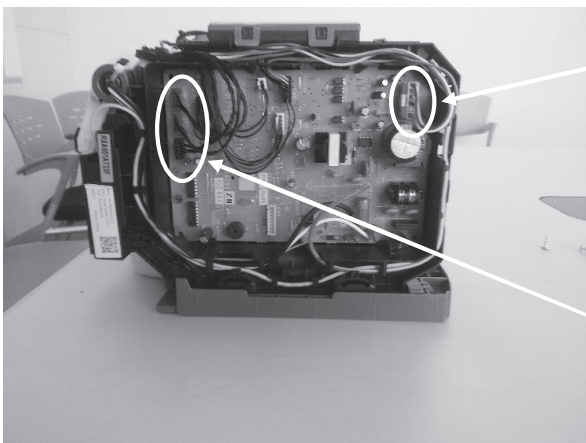

CNU

{ CNM  
CNY  
CNX



(9) Pull out control.

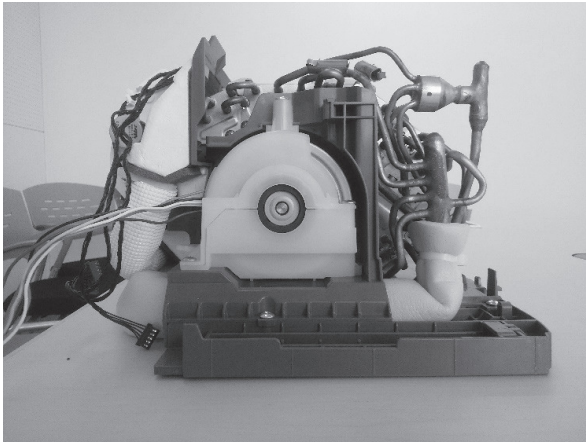

(10) Pull out the drain.

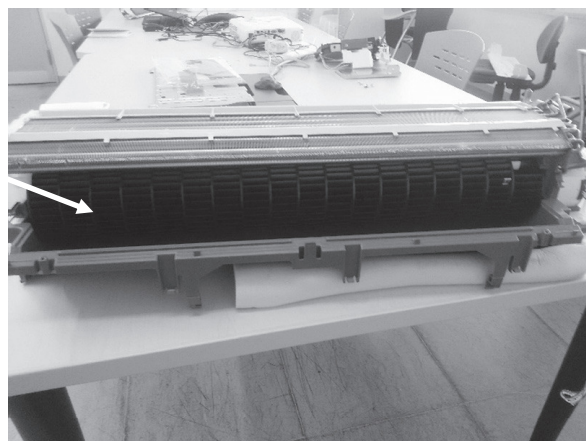
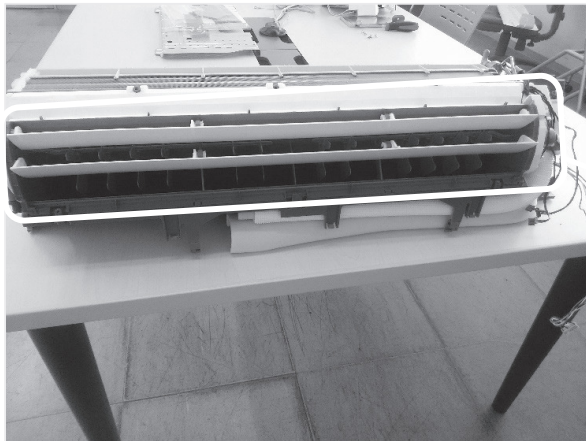

(11-1) Remove the screw (The following 3 places).

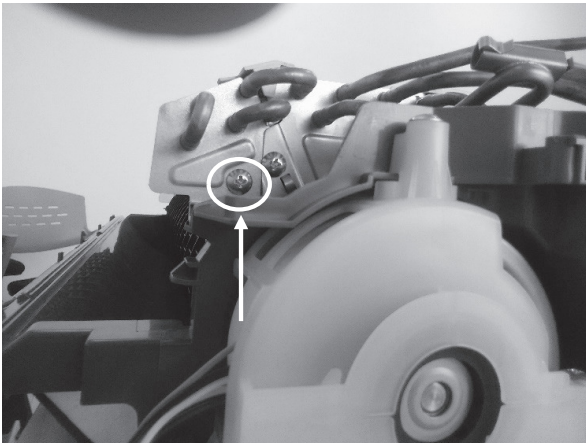
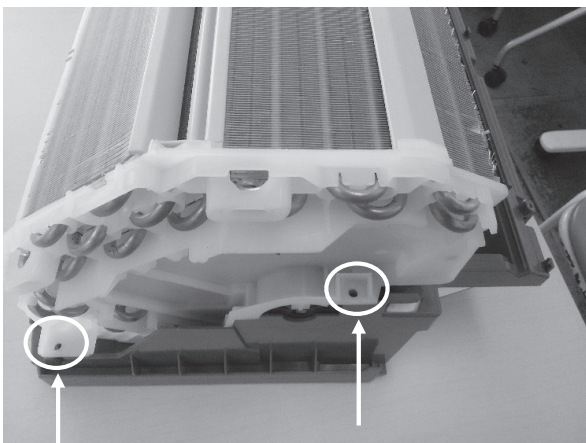

(11-2) Remove the screw (The following 3 places).

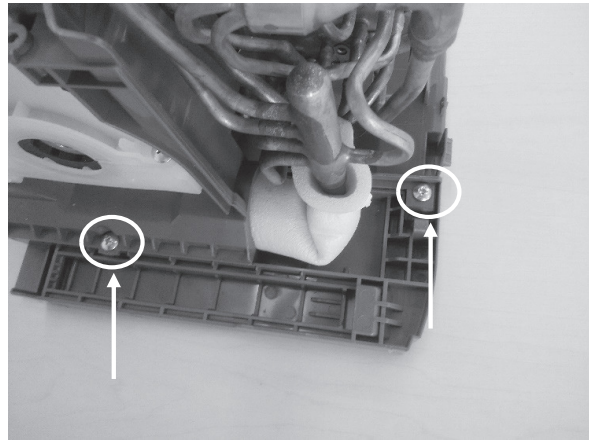
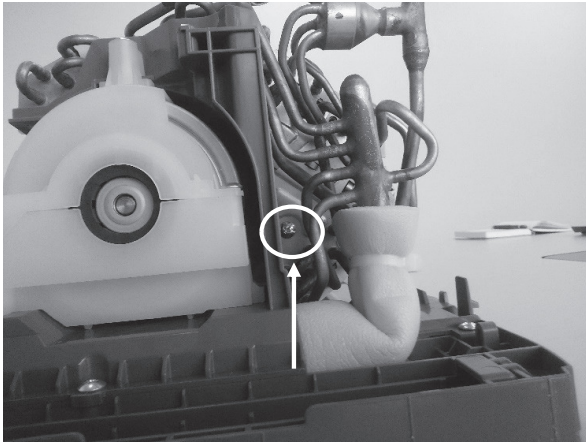

(12) Pull out heat exchanger.

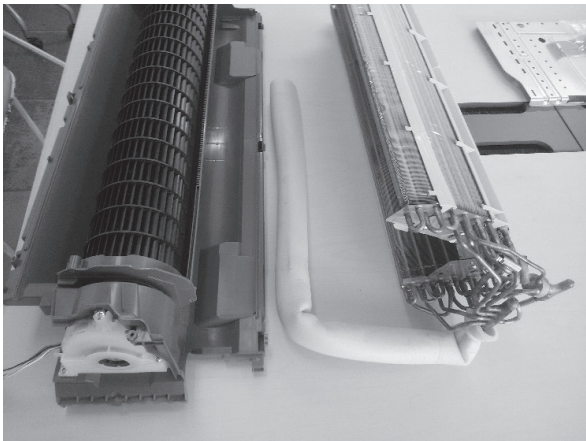

(13) Remove the fan motor fixing screw.

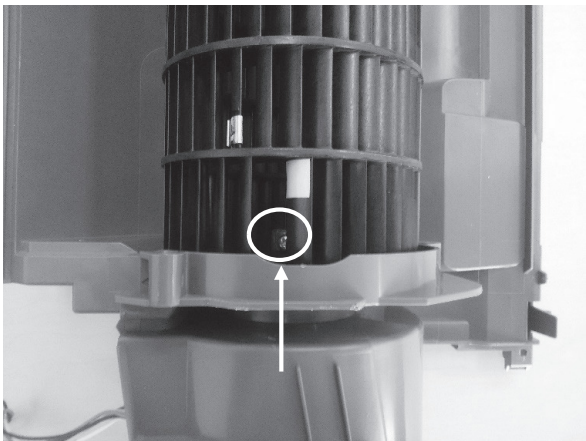

(14) Remove the screw (The following 2 places).

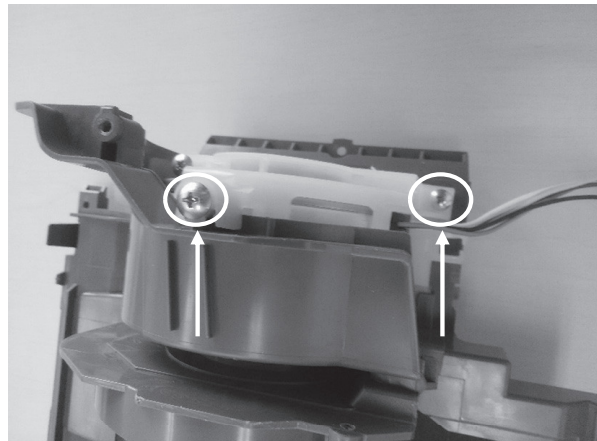



(15) The end

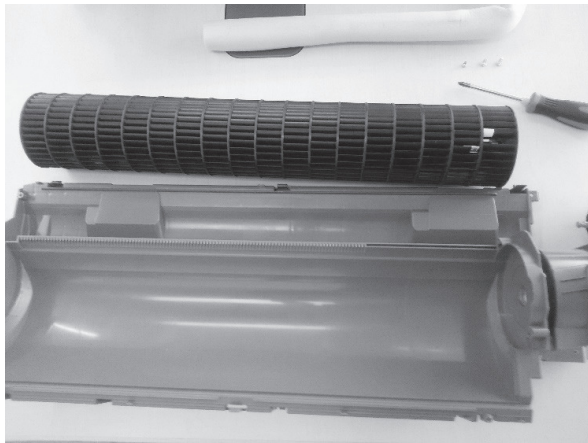

(16) Wireless LAN interface

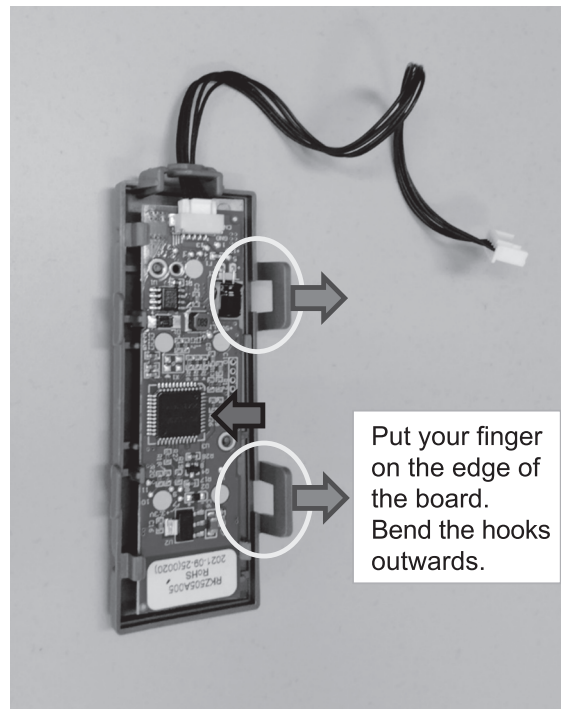
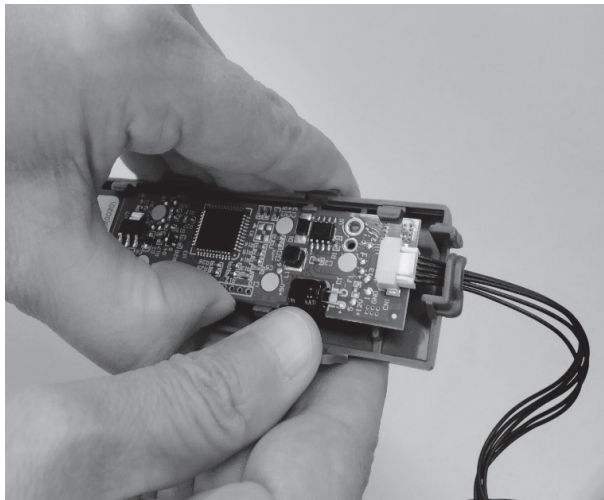

SRK15–50ZTL-W Operation table

Function	Setting	Operation by remote control	Operation by Smart M-Air	Operation by wired remote control (SC-BIKN2) *1
ON/OFF	ON	○	○	○
	OFF	○	○	○
OPERATION MODE select	AUTO	○	○	○
	COOL	○	○	○
	HEAT	○	○	○
	DRY	○	○	○
	FAN	○	○	○
	SELF CLEAN	○	○	× (Displayed as OFF)
	ALLERGEN CLEAR	○	× (Displayed as FAN)	× (Displayed as FAN)
	NIGHT SETBACK	○	× (Displayed as HEAT)	× (Displayed as HEAT)
	Home leave mode	–	○	○
	Vacant property mode	–	○	–
Temperature adjustment	18°C – 30°C	○	○	○
FAN SPEED	AUTO	○	○	○
	HIGH POWER	○	× (Displayed as ■■■■)	× (Displayed as Hi)
	Hi	○	○ (Displayed as ■■■■)	○ (Displayed as PHi)
	Me	○	○ (Displayed as ■■■)	○ (Displayed as Hi)
	Lo	○	○ (Displayed as ■■)	○ (Displayed as Me)
	ULo	○	○ (Displayed as ■)	○ (Displayed as Lo)
	ECONO	○	× (Displayed as ■)	× (Displayed as Lo)
Air flow direction adjustment	Up/down (1 step)	○	○	○
	Up/down (2 step)	○	○	○
	Up/down (3 step)	○	× (Displayed as 2 step)	× (Displayed as 2 step)
	Up/down (4 step)	○	○ (Displayed as 3 step)	○ (Displayed as 3 step)
	Up/down (5 step)	○	○ (Displayed as 4 step)	○ (Displayed as 4 step)
	Up/down (swing)	○	○	○
	Up/down (flap stopped)	○	× (Displayed as 2 step)	× (Displayed as 2 step)
	Left/right (leftmost)	○	○	○
	Left/right (left)	○	○	○
	Left/right (middle)	○	○	○
	Left/right (right)	○	○	○
	Left/right (rightmost)	○	○	○
	Left/right (wide)	○	○	○
	Left/right (spot)	○	○	○
	Left/right (swing)	○	○	○
	Left/right (louver stopped)	○	× (Displayed as middle)	× (Displayed as middle)
3D AUTO	○	○	○	
TIMER function	Various TIMERS	○	○	○
	WEEKLY TIMER	–	○	○
MENU function	Display brightness adjustment	○	–	–
	Fan control in heating thermo-OFF	○	○	○
	SELF CLEAN setting	○	–	–
	Silent setting (Silent Mode1/Mode2)	○	–	–
	Wireless LAN connection setting	○	–	–
	Wireless LAN communication	○	–	–
Other function	Installation location setting	○	–	–
	Silent *2	○	–	○
	Initialization of wireless LAN	○	–	–
	Electricity bill display	–	○	○
	Shut-off reminder alert	–	○	–

○ : Operation/Setting Available

× : Operation/Setting/Display N/A

– : No function

\*1 : Option part

\*2 : Default is mode1.

Mode1 and Mode2 cannot be set by wired remote control.

## 6. APPLICATION OPERATION MANUAL

# Smart M-Air

---

## Operation Manual

# Table of contents

(1) Application features .....	57
(2) Manipulation modes .....	59
Remote operation mode .....	59
Home restricted mode .....	59
Demo mode .....	59
(3) Preparation for use .....	60
Smartphone setting .....	60
Application initial setting .....	60
Creating user account .....	62
Registering air conditioner .....	65
Wireless LAN settings of air conditioner .....	66
Naming air conditioner .....	68
(4) Basic usage .....	70
Starting / Stopping air conditioner operation .....	70
Switching operation mode .....	70
Changing temperature .....	71
Changing fan speed and air flow direction .....	72
Switching Vacant Property Mode .....	73
(5) Using Favourites .....	74
(6) Using Options .....	78
Shut-off reminder alert .....	79
Air conditioner error notification .....	80
Hi temp/low temp alert .....	81
Watching function .....	82
Home leave mode .....	82
Cooling specific .....	84
LED ON .....	84
Number of smartphones .....	84

(7)	Setting Weekly Timer .....	85
(8)	Setting Timer by Specifying Date via Calendar .....	87
	Clear the timer set from the calendar .....	88
(9)	Displaying Electricity Bill Graph .....	90
(10)	Updating Firmware .....	91
(11)	Main Menu .....	93
	Canceling demo mode .....	94
(12)	Checking Alerts .....	95
(13)	Changing Application Settings .....	97
	Switch Operation Modes .....	98
	Switching to “Remote operation mode” .....	98
	Switching to “Home restricted mode” .....	99
	Reset Password .....	101
	Language/Time Zone Settings .....	103
	Application initialization .....	104
	Application Version Display .....	106
(14)	Troubleshooting .....	107
	When the air conditioner that you want to register does not appear in the air conditioner list screen .....	107
	How to delete a registered air conditioner .....	108
	When an abnormality notification appears in the air conditioner list .....	109
	When you forget your password and cannot log in .....	109
	When operation is performed by another account .....	110
	When "Shut-off reminder alert" does not turn on (For Android OS) .....	110

## (1) Application features

You can operate the air conditioner in each room at home or from outside.

- Setting operation reservation of every day of the week for each air conditioner
- Checking the power consumption of an air conditioner
- Setting the shut-off reminder alert
- Alerting if an air conditioner is abnormal

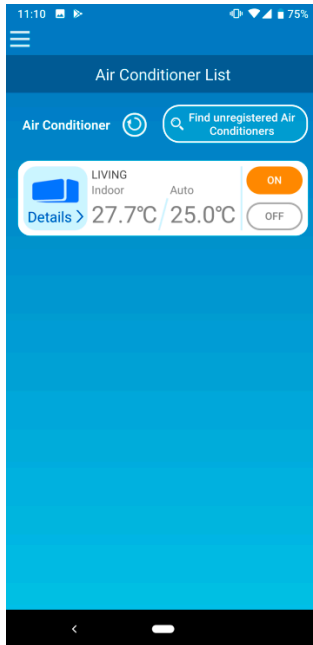

Figure 1-1



Figure 1-2

### Note

Depending on the function of the connected air conditioner, the following operation will not be reflected in the operation of the air conditioner.

- Left/Right, 3D AUTO, Home leave mode, Electricity Bill Graph

Depending on the function of the connected air conditioner, the following operation will not appear on the screen:

- Home leave mode setting, LED ON

When the wireless LAN interface is connected, the timer setting is disabled on your home remote control depending on your air conditioner.

Please use the timer function of the application to set the timer.

## (2) Manipulation modes

- Remote operation mode

This mode allows you to operate the registered air conditioner via the smartphone application when you are out of the office.

Also, you can register and operate the air conditioner at home through a smartphone application.

- Home restricted mode

This mode allows you to register and operate the air conditioner at home via the smartphone application.

You can operate without data communication to the server.

Operation is not available when you are out.

- Demo mode

If you don't have an air conditioner compatible with a smartphone app, This mode allows you to experience the operation feel of remote operation mode.



### (3) Preparation for use

- Smartphone setting

Turn on Wi-Fi of your smartphone.



Figure 3-1

- Application initial setting

Tap the Smart M-Air icon.



Figure 3-2



The application starts.

Figure 3-3



After startup, the “Language/Time Zone Settings” screen appears.

Select a language to use in the application.

Select a time zone. Select the time zone in which the air conditioner to operate via the application exists.

Choose the unit of temperature.

Finally, tap  on the top right to complete the setting.

Figure 3-4

The “Terms of Service” screen appears. Read the text to the bottom and check the description. If you agree it and use the application, tap [Agree]. When you tap [I don’t agree], the application exits.



Android

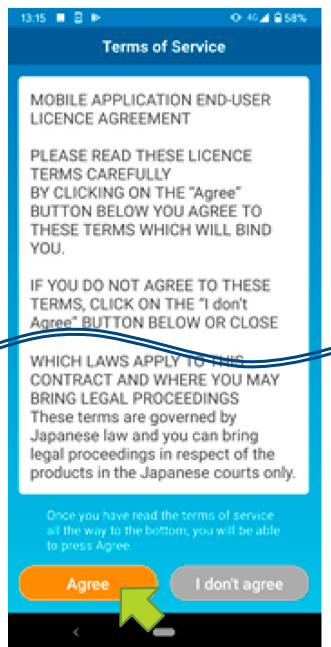
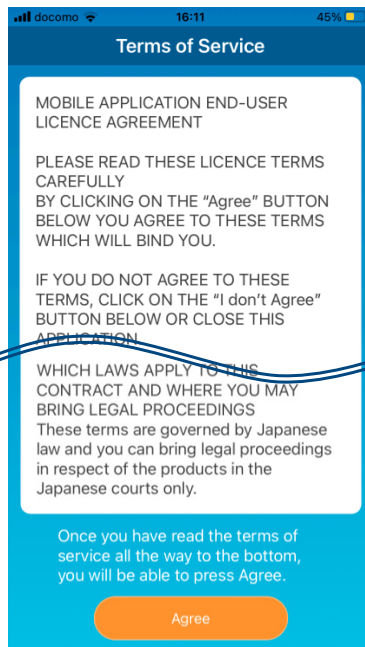

iOS

Figure 3-5

On the startup screen, select a mode to use.

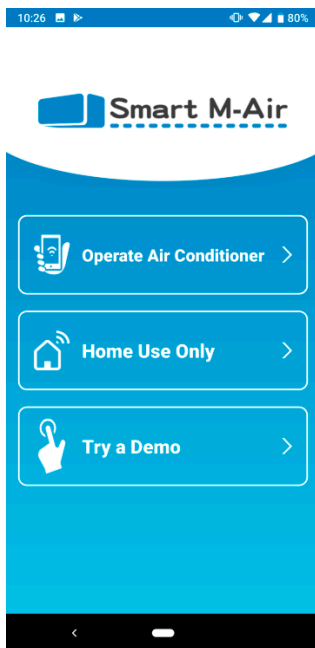

Figure 3-6

■ Operate Air Conditioner (Remote operation mode)

Tap "Operate Air conditioner" for remote control or to use optional functions such as weekly timer.

→ To ["Creating user account"](#)

■ Home Use Only (Home restricted mode)

Tap "Home Use Only" to operate only at home. Some functions are restricted, but you can change to remote operation mode at any time.

→ To ["Registering air conditioner"](#)

Switching operation mode

→ To ["Changing Application Settings"](#)

■ Try a Demo (Demo Mode)

Tap "Try a Demo" to try out the app's features. (Some features only)

→ To ["4. Basic Usage"](#)

• Creating user account

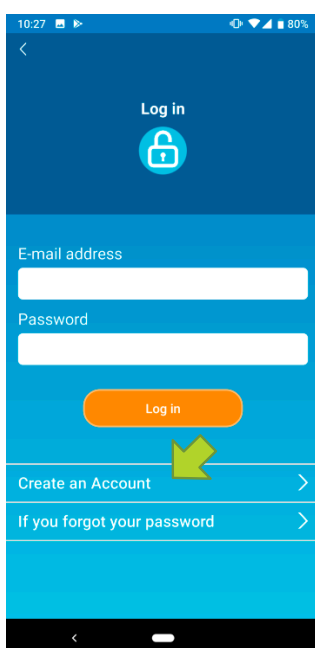

Figure 3-7

Tap [Create an Account].



Figure 3-8

Read the text of Handling of Personal Information to the bottom and check the description.  
If you agree it and use the application, tap [Agree].

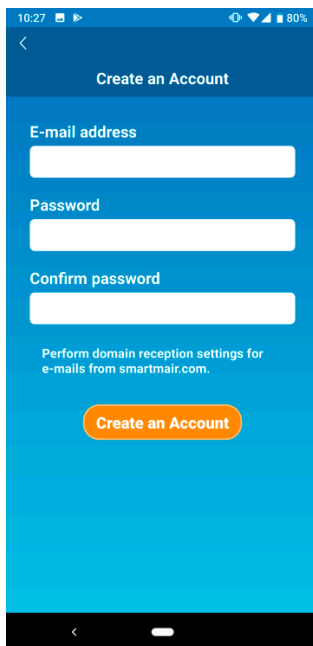

Figure 3-9

The “Create an Account” screen appears.  
Enter your e-mail address and password and tap the [Create an Account] button.

### Note

- A password must be between 8 to 16 characters including at least one alphabetic character and one numeric character.

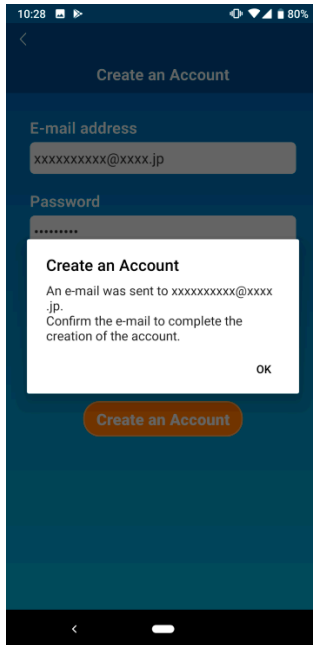

Figure 3-10

When the pop-up message “Create an Account” appears, tap [OK].

The email containing the URL of the authentication screen will be sent to the email address you entered, so please click the URL within 24 hours to complete the account creation.

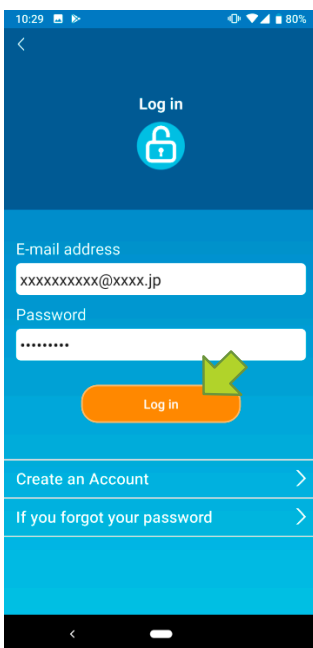

Figure 3-11

After the account is created, the “Log in” Screen appears on the application.

Click the URL written in the e-mail, enter the registered e-mail address and password, and tap the [Log in] button.

If you forget your password and cannot log in, tap "If you forgot your password" and set a new password.

→ To [“Reset Password”](#)

• Registering air conditioner

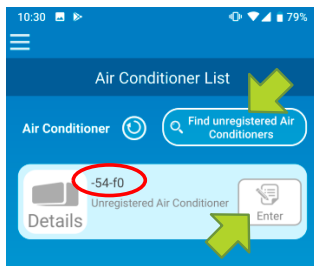

Figure 3-12

Use the “Air Conditioner List” screen to register an air conditioner to operate.

Tap the "Find unregistered Air Conditioners" button to display air conditioners that are not registered on your smartphone.

The air conditioner name ( -54-f0 locations) displays the last 6 digits of the SSID on the label of the wireless LAN interface.

Tap the [Enter] button.

- When the air conditioner is not displayed on the list screen  
→ To [“When the air conditioner that you want to register does not appear in the air conditioner list screen”](#)
- To delete a registered air conditioner  
→ To [“How to delete a registered air conditioner”](#)

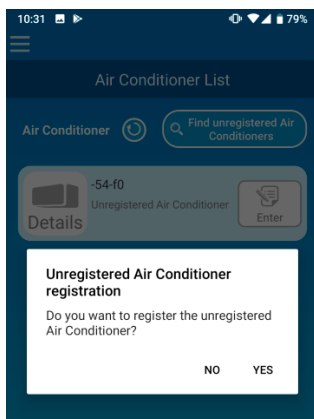

Figure 3-13

To register the air conditioner, tap [YES] on the pop-up message displayed.

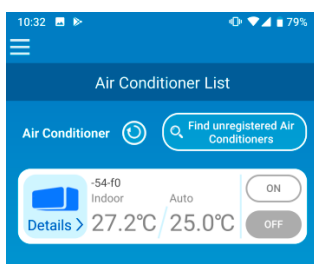

Figure 3-14

- Wireless LAN settings of air conditioner

If your wireless LAN router does not support WPS, manually make wireless LAN settings of your air conditioner.

Set the wireless LAN interface to the AP mode, and then change the Wi-Fi connection destination of your smartphone to “Smart-M-Air-XXXX”.

“XXXX” is the last 4 alphanumeric characters of the MAC address of the wireless LAN interface.

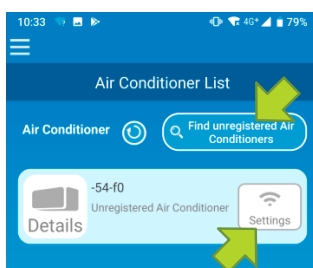

Figure 3-15

On the “Air Conditioner List” screen, tap the [Find unregistered Air Conditioners] button. The target air conditioner appears.

Tap the [Settings] button.

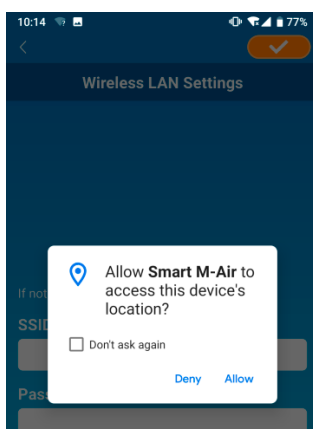



Figure 3-16

If you are prompted to permit access to location information, tap [Allow].

When you tap the network you want to set from the displayed list, the SSID appears in the "SSID" entry field at the bottom of the screen, enter "Your home Wi-Fi password" below it, and tap  in the top right.

If the network you want to set is not displayed in the list, enter "SSID" and "Your home Wi-Fi password" directly, then tap  on the top right to set.

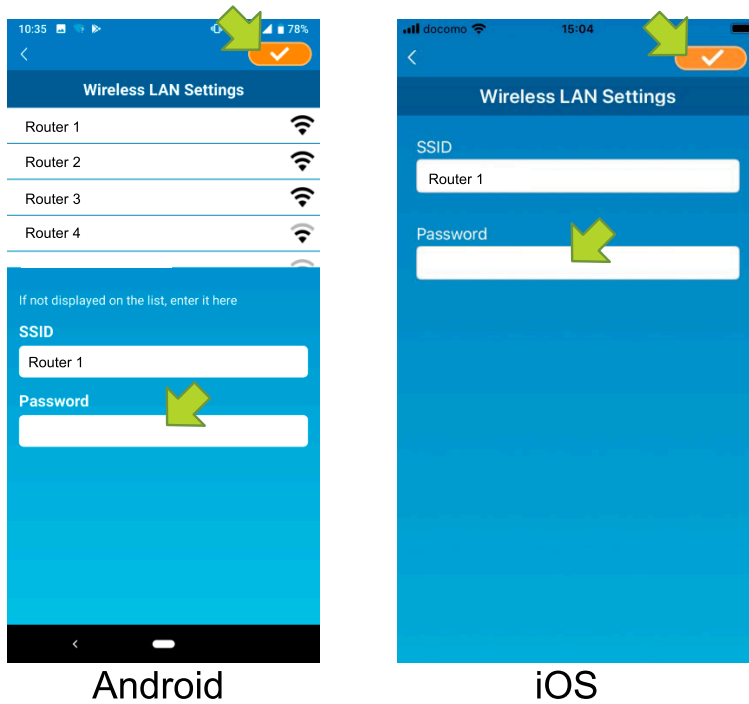

Figure 3-17

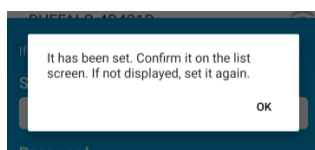

Figure 3-18

After the wireless LAN settings is completed, the air conditioner is registered.



- Naming air conditioner

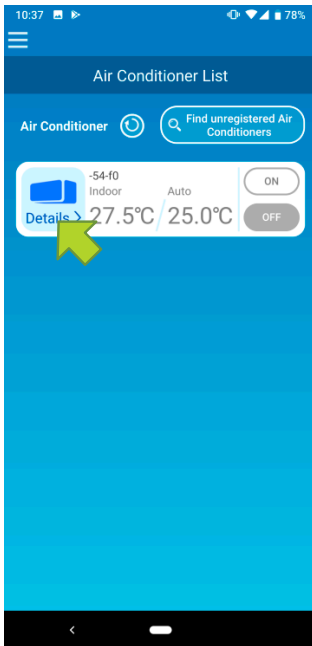

Figure 3-19

If you want to change the name of the air conditioner displayed in the application such as the air conditioner list screen, tap "Details" to display the detailed screen of the air conditioner.

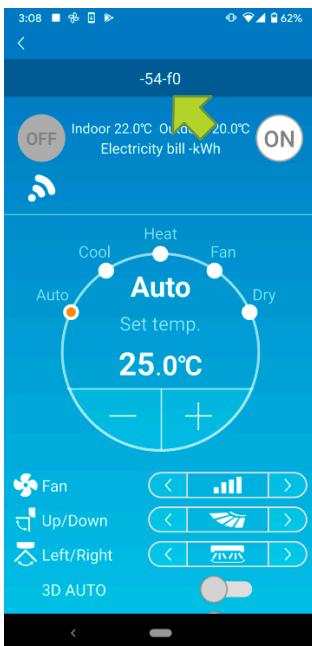

Figure 3-20

Press and hold down (1 second) an air conditioner name. The “Edit Air Conditioner name” dialog appears. Use this to change the name.

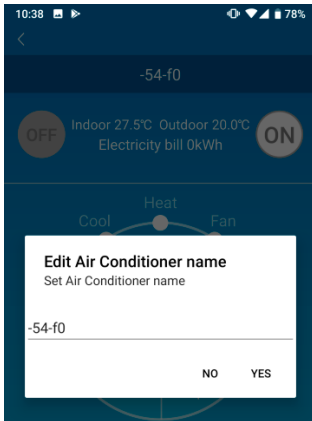

Figure 3-21

Enter a new air conditioner name and tap [YES].

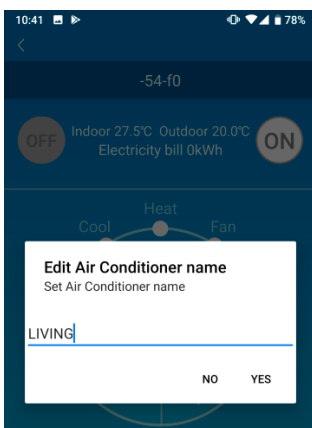

Figure 3-22

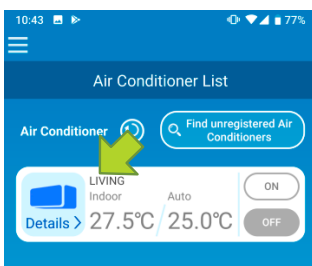

Figure 3-23

## (4) Basic usage

- Starting / Stopping air conditioner operation

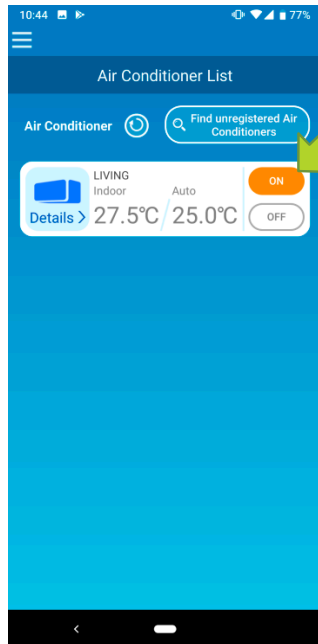

Figure 4-1

To start or stop the operation, tap the [ON] / [OFF] button of the air conditioner that you want to operate on the “Air Conditioner List” screen.

When the button color changes, switching is complete. (Grayed out when off)

To update to the latest information, tap  .

### Note

- When operating an air conditioner from an external location, it may take up to one minute to complete the air conditioner operation.

- Switching operation mode

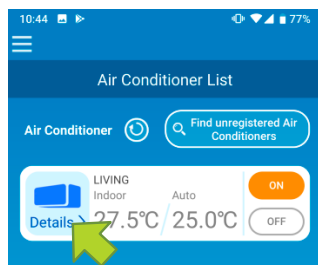

Figure 4-2

Tap an air conditioner that you want to switch the operation mode on the “Air Conditioner List” screen.

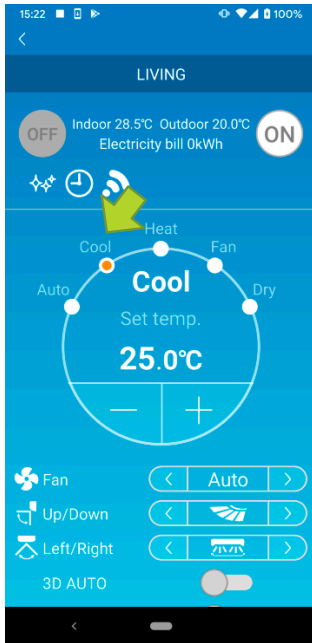





Figure 4-3

To change the “Operation mode”, tap each mode from “Auto” to “Dry”.

 appears when the air conditioner is in clean mode. To cancel clean mode, tap .

 appears when the weekly timer is set by this application.

 appears when the application is used at home where the air conditioner is set and connected to the application.

- Changing temperature

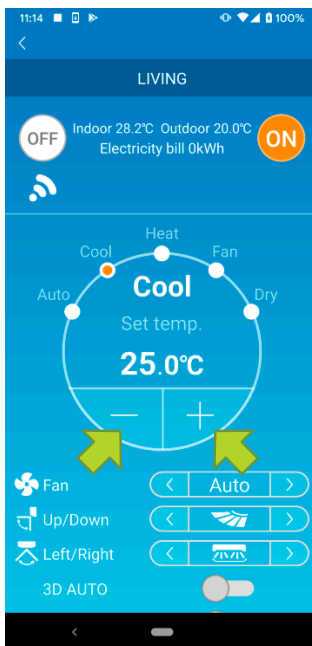

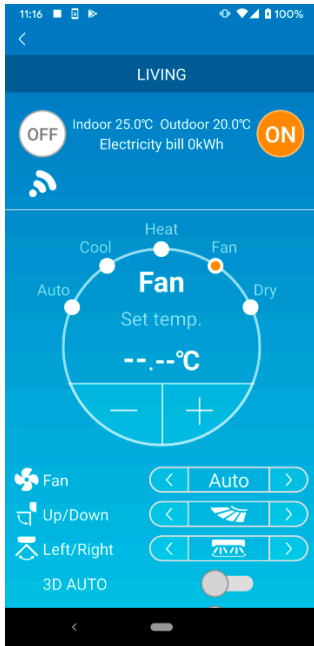

Figure 4-4

To set a desired temperature, tap  /  . The current set temperature appears in the circle.



When the operation mode is Fan, Set temp. shows "-".

Figure 4-5

- Changing fan speed and air flow direction

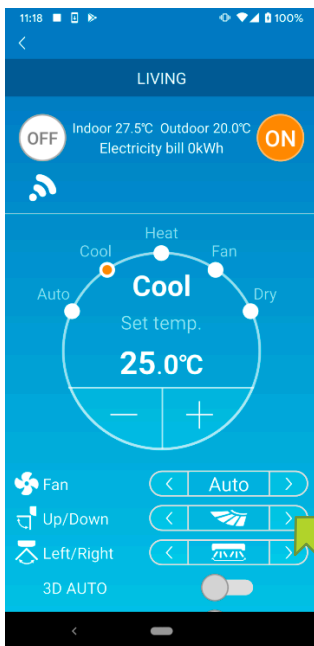

Tap < / > to change settings.

Figure 4-6

## • Switching Vacant Property Mode

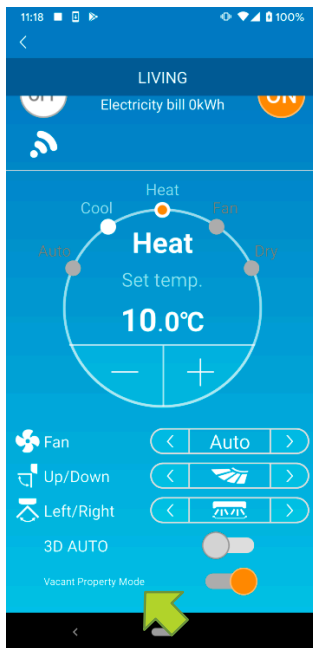

Figure 4-7

When Vacant Property Mode is ON, operation mode and Set temp. can be set as follows.

- Cool : Set temp. 31°C to 33°C (at 1°C intervals)
- Heat: Set temp. 10°C to 17°C (at 1°C intervals)

Only "Cool" or "Heat" can be set as an operation mode.

## (5) Using Favourites

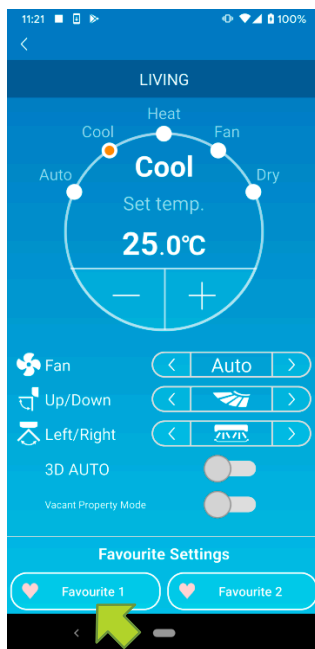



Figure 5-1

Register your desired settings of “Set temp”, “Operation mode”, “Fan”, “Up / Down” and “Left / Right” with Favourite. Tapping the [Favourite] button changes the current settings to the registered settings.

On the air conditioner details screen, press and hold down (1 sec) the [Favourite 1] or [Favourite 2] button. The “Favourite” screen appears.



Figure 5-2

Change each item to your favourite setting, and tap  on the top right to add it to Favourites.

Press  in the upper left of the screen to return to the operation screen.

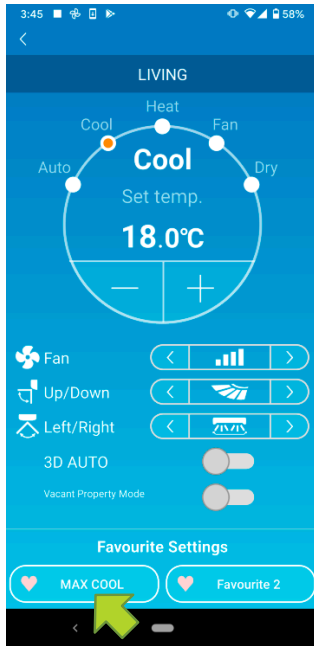

Figure 5-3

When you tap the [Favourite 1] or [Favourite 2] button, the current settings are changed to the favourite settings you tapped.



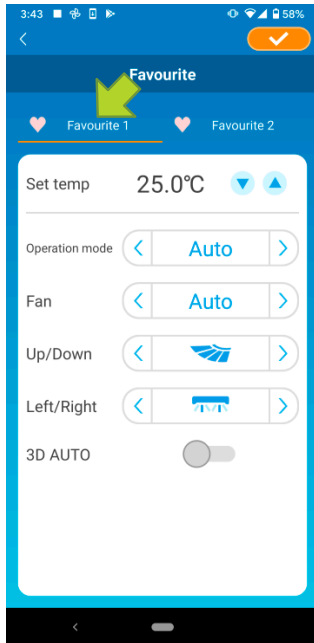

Figure 5-4

To change the name of the "Favourite" button, press and hold down the "Favourite" button for approximately 1 second. "Edit Favourite name" dialog appears to change the name.

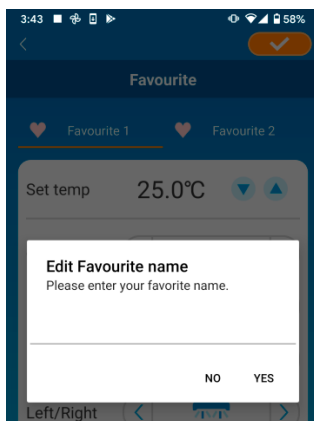

Figure 5-5

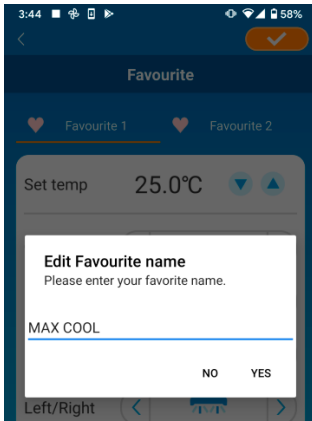

Figure 5-6

Enter the new favourite name and tap [YES].

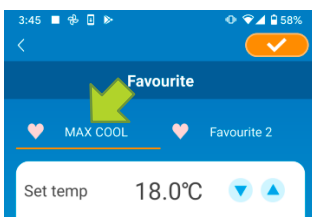

Figure 5-7

## (6) Using Options

You can make various option settings such as alerts and LED lighting, and check the number of accounts registered with an air conditioner.

Home restricted mode : Only “Home Leave Mode”, “Cooling specific” and “LED ON” are operable.

Demo mode : Options are not operable.

You can switch to remote operation mode using "Changing Application Settings" in the main menu.

→ To [“Changing Application Settings”](#)

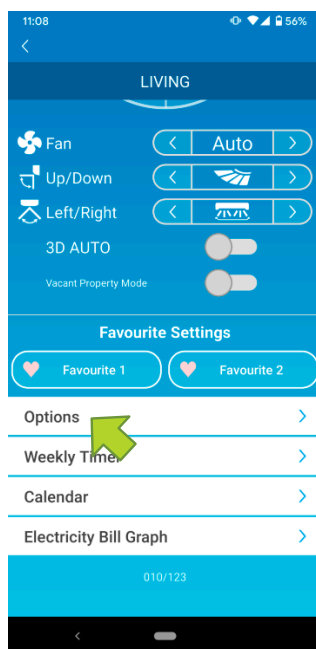

Tap [Options] on the lower part of the air conditioner details screen. The “Options” screen appears.

Figure 6-1

Only "LED ON" is ON by default.

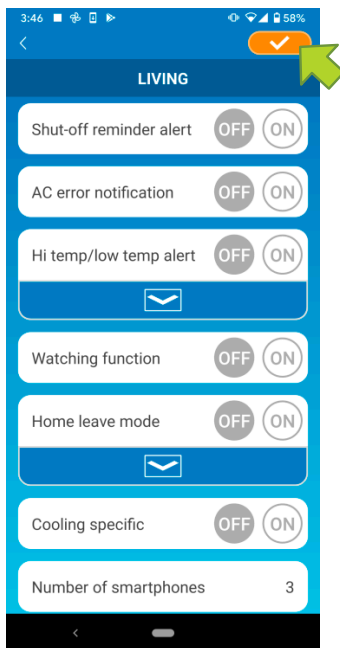



Figure 6-2

Switch between [ON] and [OFF], and tap  on the top right of the screen to save the settings you changed.

### Note

- Shut-off reminder alert, AC error notification, Hi temp/low temp alert, Watching function can be used with "Remote operation mode".

## • Shut-off reminder alert

If you are more than 1 km away from the air conditioner you are driving, you can receive a push notification to the smartphone application.

- To receive alerts, tap [ON].

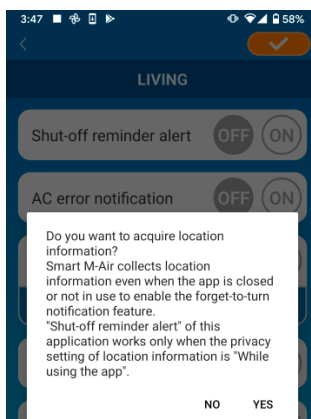



Figure 6-3

When the pop-up message appears, tap [YES] and then tap  on the top right.

- To not to receive alerts, tap [OFF].

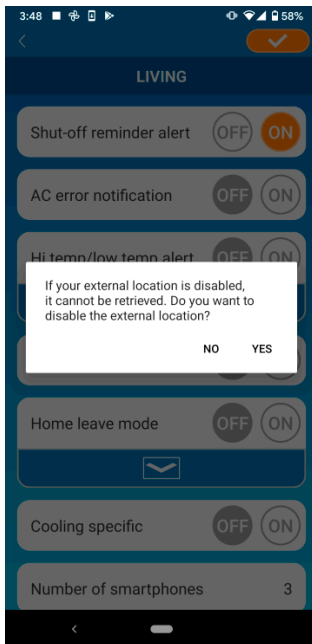



Figure 6-4

When the pop-up message “If your external location is disabled, it cannot be retrieved. Do you want to disable the external location?” appears, tap [YES] and then tap  on the top right.



### Note

- Acquisition of location information is performed by using the location of your smartphone as the location of the air conditioner. Perform location information acquisition near your air conditioner.

- AC error notification (Air conditioner error notification)



If any abnormality is detected in your air conditioner, an e-mail is sent to the registered e-mail address.

→ To “[When an abnormality notification appears in the air conditioner list](#)”

- To receive notifications, tap [ON] and then tap  on the top right.
- To not to receive notifications, tap [OFF] and then tap  on the top right.

- Hi temp/low temp alert

When the air conditioner reaches the specified high/low temperature condition, a push notification is sent to the smartphone application.

- To receive alerts, tap [ON] and enter the high and low temperatures and then tap  on the top right.
- To display the high and low temperatures input area, tap . To hide it, tap .

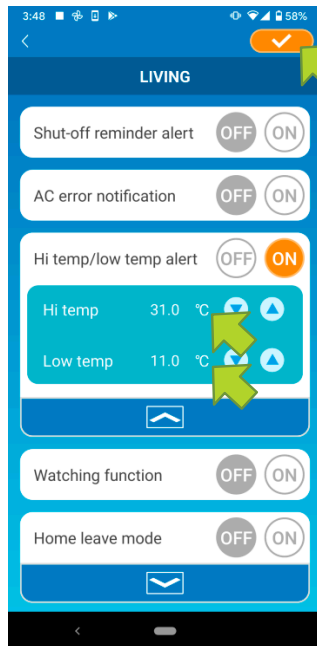



Figure 6-5

### Note

- When the room temperature is higher / lower than the temperature specified here, alerts are sent. If you set the high temperature at 31°C, an alert is sent when the room temperature exceeds 31°C. No alert is sent at 31°C.
- Setting only either of high or low temperature receives alerts only for high or low temperature.

- To not to receive alerts, tap [OFF] and then tap  on the top right.



- Watching function

When the air conditioner is controlled other than your smartphone, an e-mail is sent to the registered e-mail address.

---

**Note**

- The notification also applies to the operation with the timer of the air conditioner itself and the end of internal clean operation.
- 

- To receive alerts, tap [ON] and then tap  on the top right.
- To not to receive alerts, tap [OFF] and then tap  on the top right.

- Home leave mode

When the room temperature is lower than a setting temperature, heating is turned on automatically.

When the room temperature is higher than a setting temperature, cooling is turned on automatically.

- To use “Home leave mode”, tap [ON].

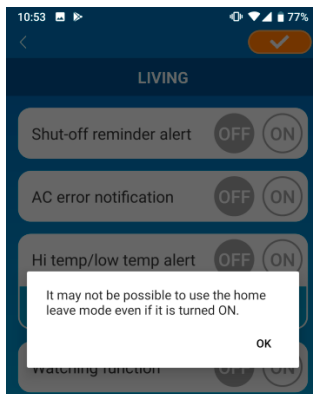



Figure 6-6



When the pop-up message “It may not be Possible to use the Home leave mode even if it is turned ON.” appears, tap [OK] and then tap  on the top right.

---

**Note**

- There is no "Home leave mode" depending on the air conditioner connected. In this case, "ON" has no effect.
- 

- To not to use “Home leave mode”, tap [OFF] and then tap  on the top right.

- To change the setting of home leave mode, tap . To hide them, tap . The following settings can be changed.

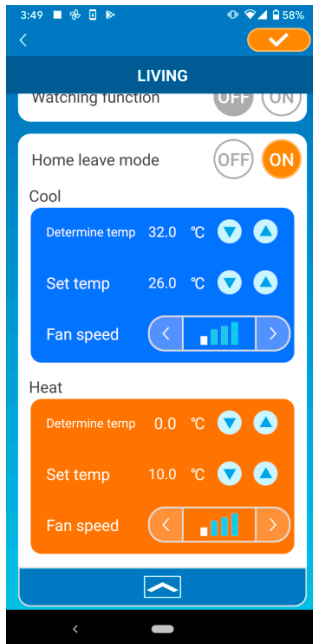

Figure 6-7

- Determine temp : Set the preferred outside temperature to start the operation of the air conditioner in cooling/heating mode.

Allowable setting range in cooling :  
26°C to 35°C (at 3°C intervals)

Allowable setting range in heating :  
0°C to 15°C (at 5°C intervals)

- Set temp : Set the preferred indoor temperature to operate in cooling/heating mode.

Allowable setting range in cooling :  
26°C to 33°C (at 1°C intervals)

Allowable setting range in heating :  
10°C to 18°C (at 1°C intervals)

- Fan speed : Set the fan speed in cooling/heating mode.

[example]

Cooling → When you input the determine temp. as 32°C, set temp. as 26°C and the fan speed at the slowest, the air conditioner will start operating at 26°C with the slowest fan speed when the outside temperature reaches to 32°C.



- Cooling specific

If you set it as an air conditioner for cooling only, you won't be able to use the heating in the smartphone application.

- To use “Cooling specific”, tap [ON] and then tap  on the top right.

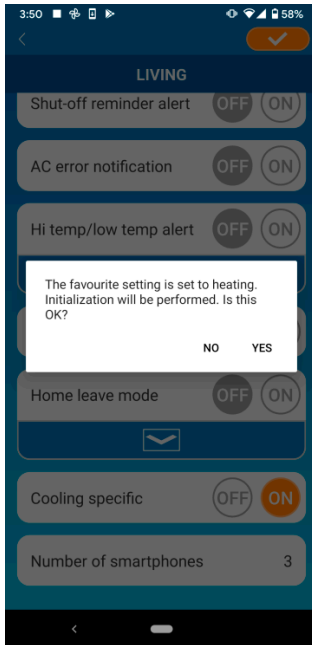



Figure 6-8



- When “ON” is set or “Heat” is set to favourites, the pop-up message asking whether to initialize favourites appears.

If you tap [YES] on the pop-up message, the “Cooling specific” setting is turned “ON” to initialize the favourite with heating set.

- To not to use “Cooling specific”, tap [OFF] and then tap  on the top right.

- LED ON

Lights up the LED of the wireless LAN interface.

- To use LED lighting, tap [ON] and then tap .
- To not to use LED lighting, tap [OFF] and then tap .

- Number of smartphones

Displays the number of smartphones registered with the air conditioner.

## (7) Setting Weekly Timer

Makes the timer setting for every day of the week.

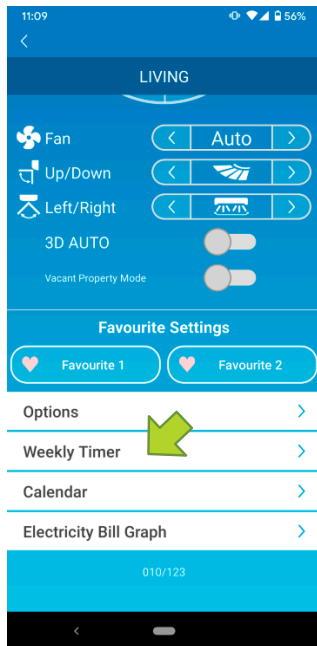

Tap [Weekly Timer] on the lower part of the air conditioner details screen.

The “Weekly Timer” screen appears.

Figure 7-1

Tap  on the top right of the screen to save the settings you changed.

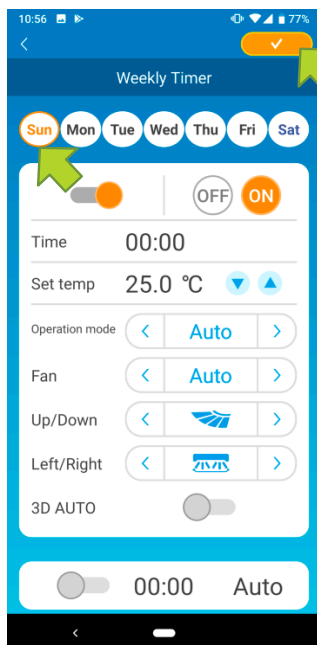

Tap the day of the week you want to set to display the timer list for that day of the week.

You can set up to six timers for each day of the week, but you cannot set the same time for the same day.

Figure 7-2

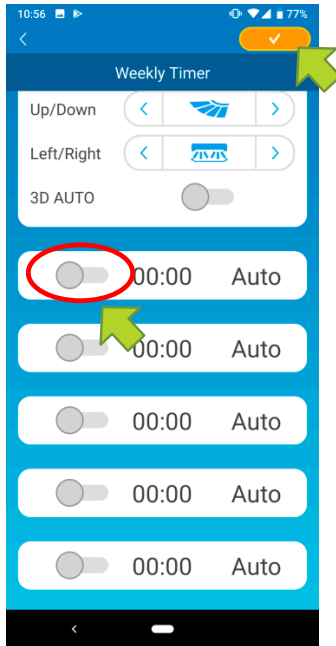

Figure 7-3

A disabled timer shows the time and operation mode only.

Tap the switch at  to enable and edit.

Edit each item and tap  on the top right to set the timer on the target day.

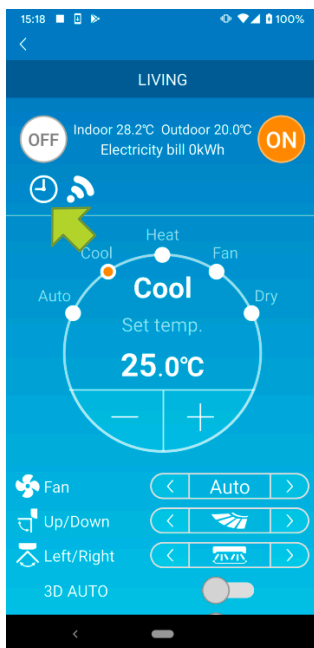

Figure 7-4

When at least one timer setting is ON, the timer icon appears on the air conditioner detail screen.

The timer you set here is applied to every week on that day.

To turn off the timer only on a certain day, or to apply the timer of another day, set individually from the “Calendar” screen.

## (8) Setting Timer by Specifying Date via Calendar

When you set the weekly timer, the same timer is applied to the same day every week. To turn off the timer or set the timer of a different day on a certain day, set individually from the “Calendar” screen.

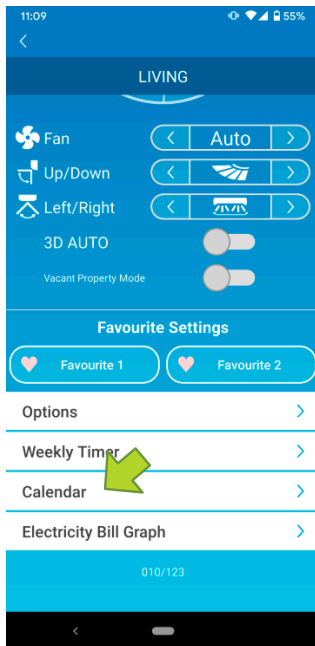

Figure 8-1

Tap [Calendar] on the lower part of the air conditioner details screen.

The [Calendar] screen appears.

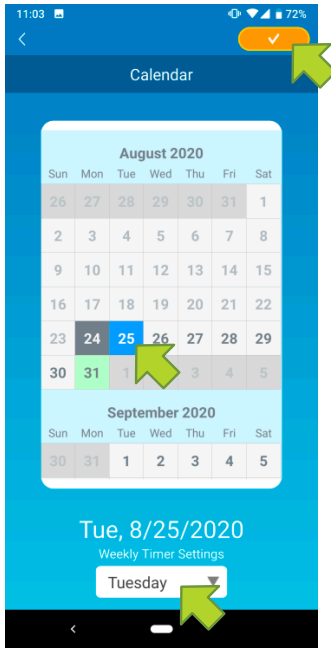



Figure 8-2

Tap the date of the calendar. Select the timer of the day of the week that you want to apply from “Weekly Timer Settings” and tap  on the top right of the screen.

If you select “OFF” from “Weekly Timer Settings”, the weekly timer is not applied.

When the timer of a different day of the week is applied or the timer is turned off, the date appears in green.

- Clear the timer set from the calendar

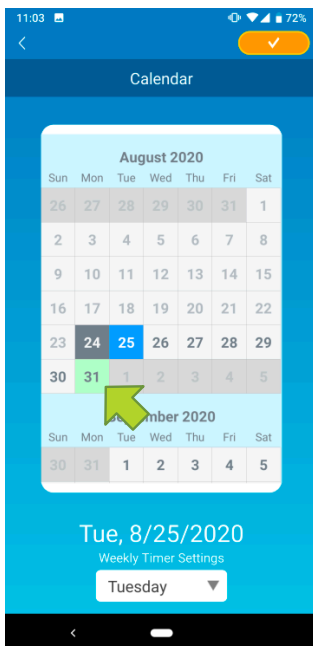
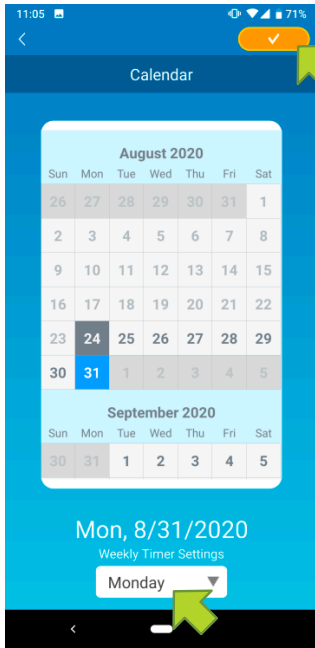

Figure 8-3

Tap the date whose timer you want to clear.



From “Weekly Timer Settings”, select the same day of the week as the date to clear and tap



Figure 8-4

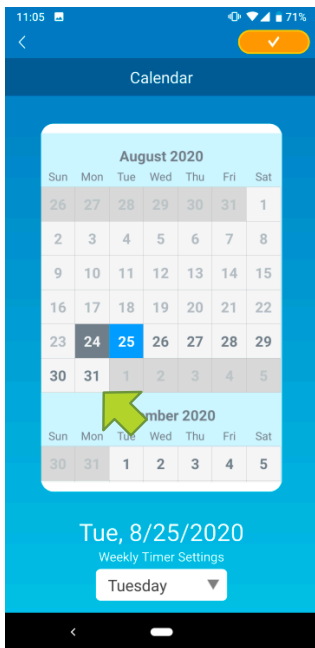

When cleared, the background of the date is displayed in white.

Figure 8-5

## (9) Displaying Electricity Bill Graph

Displays an electricity bill by month on a graph. You can also set the electricity unit cost.

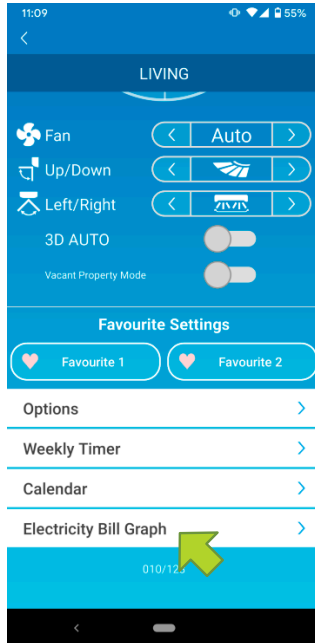

Figure 9-1

### Note

Depending on the type of air conditioner you connect, the function may be disabled.

Tap [Electricity Bill Graph] on the lower part of the air conditioner details screen.

The “Electricity Bill Graph” screen appears.

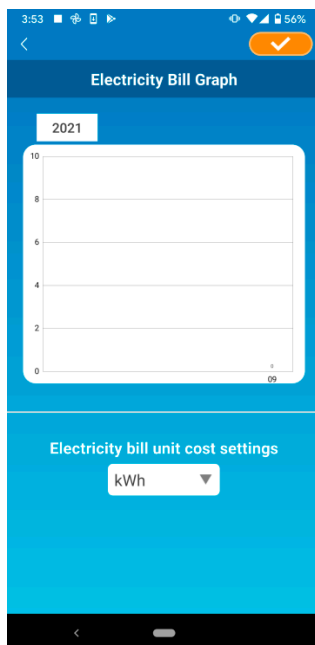

Figure 9-2

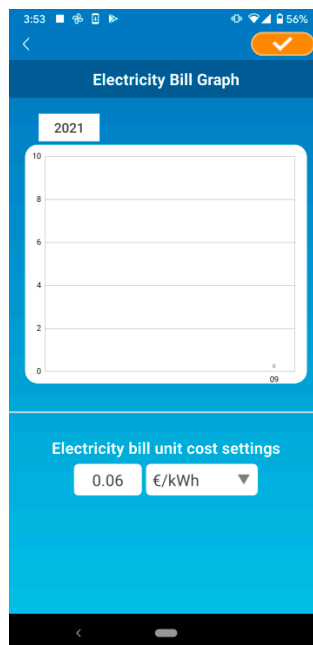



Figure 9-3

If you change the electricity bill unit cost settings, you can enter a unit price by changing the unit of measure.

After editing, tap  to save the setting.

## (10) Updating Firmware

If the firmware of your wireless LAN interface is not up to date, an exclamation mark **!** appears on the “Air Conditioner List” screen.

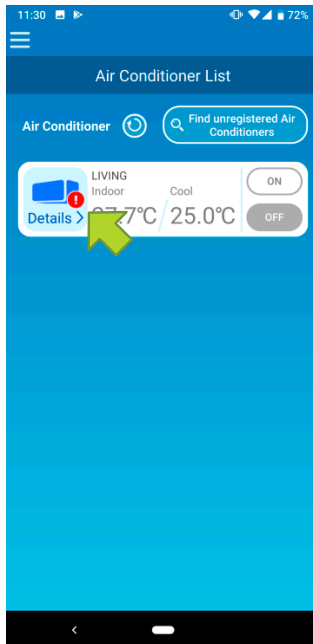

Figure 10-1

Tap [Details] to display the air conditioner details screen.

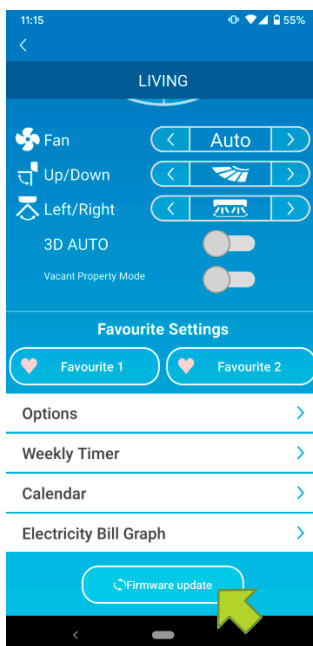

Figure 10-2

Tap the [Firmware update] button.

### Note

- Perform the firmware update in the same wireless LAN area as the air conditioner.
- Please turn off the air conditioner in advance.
- If firmware update is disabled, the button is not enabled.



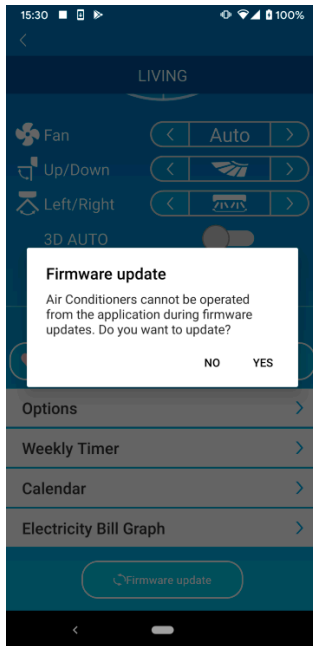

Figure 10-3

Tap [YES] to update the firmware to the latest one.

The firmware update takes 10 minutes (Max). The operation from the application is not accepted during that period.

If after 10 minutes (Max) the "Firmware update" button appears, retry the firmware update.

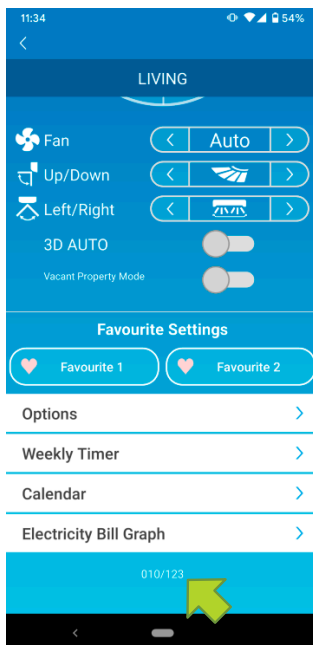

Figure 10-4

When the firmware becomes up to date, the firmware version appears instead of the [Firmware update] button.

## (11) Main Menu

Tap the menu button (☰) that appears on the top left in the screen such as “Air Conditioner List”, to display the main menu.

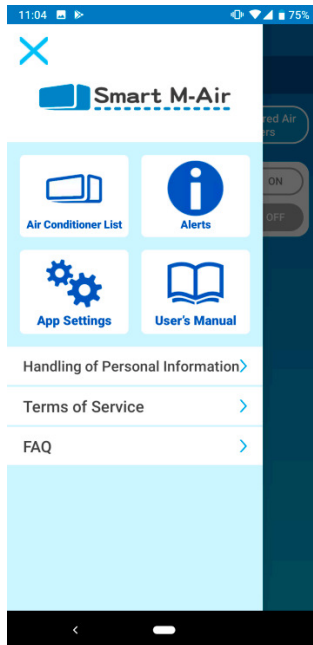
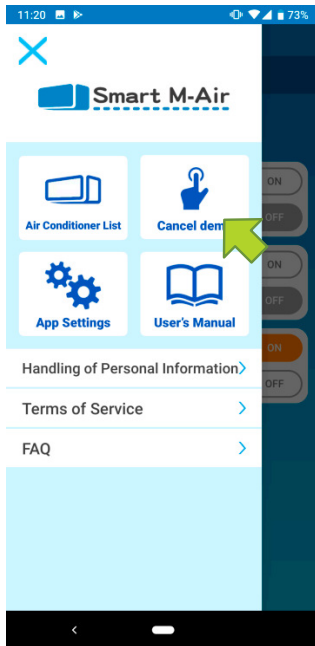

Figure 11-1

- Air Conditioner List : Operates or sets an Air conditioner.
- Alerts : Checks alerts.
- App Settings : Switches the operation mode or sets the password.
- User's Manual : Displays the user's manual.
- Handling of Personal Information : Displays the handling of personal information.
- Terms of Service : Displays the terms of service.
- FAQ : Displays the FAQ.

- Canceling demo mode



In the demo mode  
Cancel demo : Exits the demo mode.

Figure 11-2

## (12) Checking Alerts

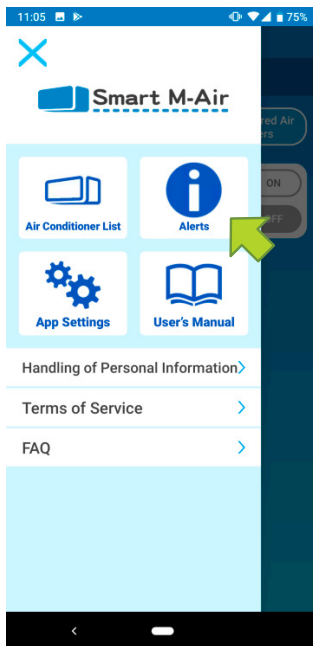

Open the main menu and tap [Alerts].

Figure 12-1

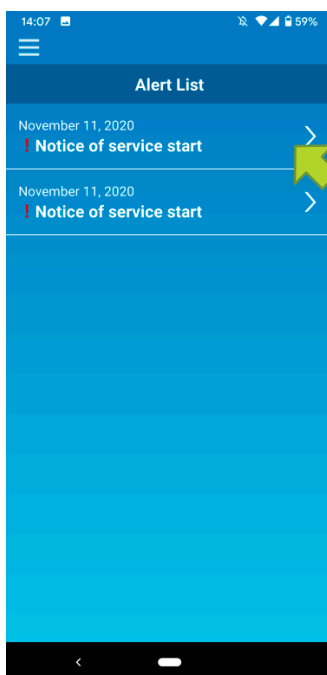

A list of alerts appears.

Tap each alert to display the alert details screen and check it.

**!** appears to the alert that is not checked in the alert details screen.

Figure 12-2

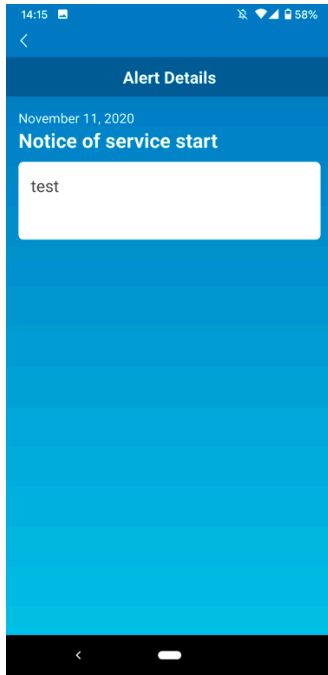

Figure 12-3

## (13) Changing Application Settings

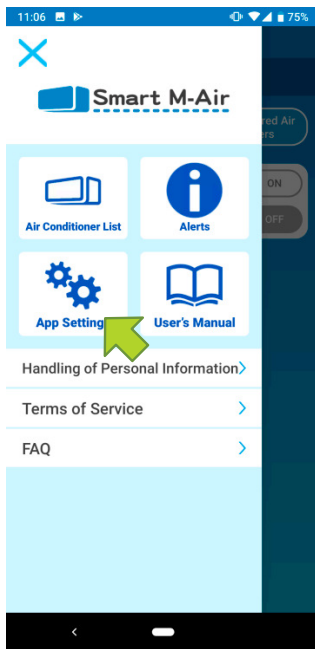

Figure 13-1

Open the main menu and tap [App Settings].

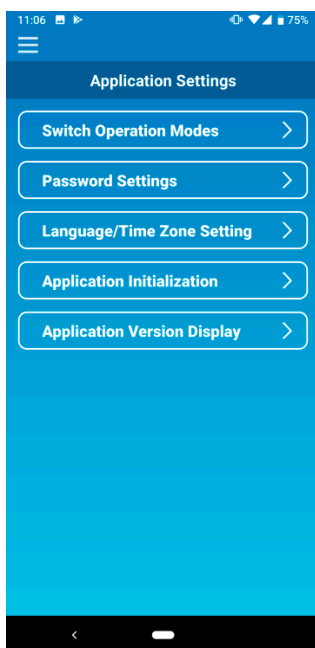

Figure 13-2

The “Application Settings” screen appears.

- **Switch Operation Modes:** Switches between the remote operation mode and home restricted mode.
  - To [“Switch Operation Modes”](#)
- **Password Settings:** Sets a password.
  - To [“Reset Password”](#)
- **Language/Time Zone Settings:** Sets a language to use in the smartphone application and a time zone for an air conditioner.
  - To [“Language/Time Zone Settings”](#)
- **Application Initialization:** Initializes the smartphone application.
  - To [“Application Initialization”](#)
- **Application Version Display:** Displays the version of your smartphone application.
  - To [“Application Version Display”](#)

## Note

- In "Home restricted mode", you cannot operate "Password Settings". In "Try a Demo", only "Language/Time Zone Settings" and "Application Version Display" can be operated. Functions that cannot be operated are displayed in gray, and nothing is displayed even if you tap them.

## • Switch Operation Modes

You can see the current operation mode.

To switch the operation mode, select the desired mode and tap  .

## • Switching to “Remote operation mode”

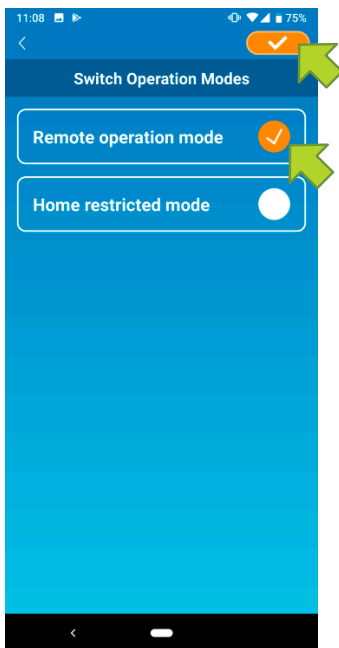

Tap [Remote operation mode] → Tap  on the top right to switch the mode.

Figure 13-3

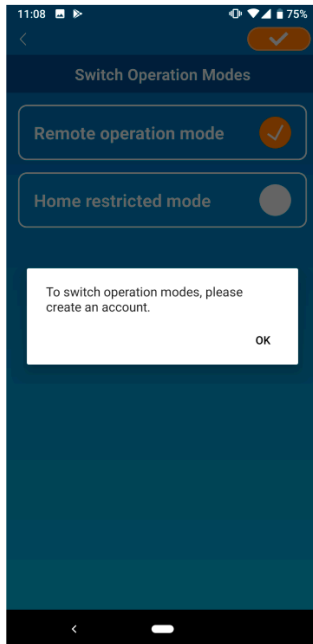

Figure 13-4

When the account creation pop-up message appears, tap [OK], agree with the handling of personal information, and create an account.

→ To [“Creating user account”](#)

- Switching to “Home restricted mode”

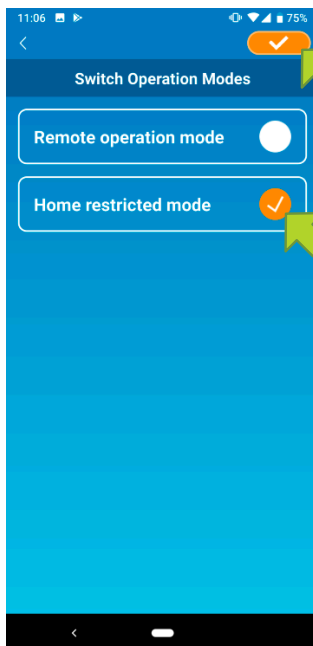



Figure 13-5

Tap [Home restricted mode] → Tap  on the top right to switch the mode.

### Note

- Note that if you switch the mode to “Home restricted mode”, the account information used in “Remote operation mode” is deleted.



The popup for remote control disabled and the popup for deleting server data will appear, so tap [YES].

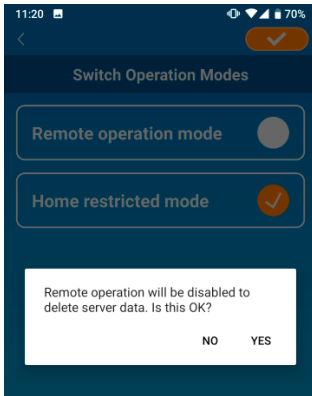

Figure 13-6

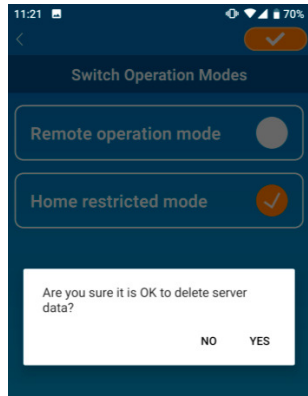

Figure 13-7

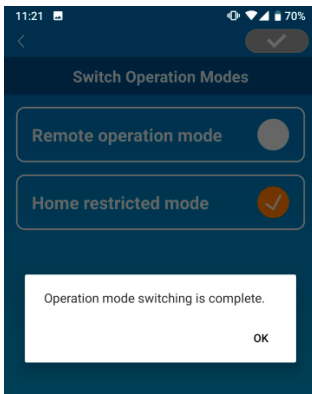

Figure 13-8

When the operation mode switching completion pop-up message appears, tap [OK].

## • Reset Password

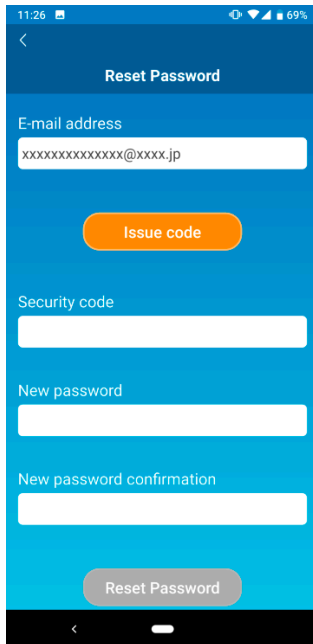



Figure 13-9

Enter the registered e-mail address and tap the [Issue code] button.

### Note

- After tapping the [Issue code] button, keep this screen displayed until the password resetting is completed. If you tap  and return to the previous screen, these operations are canceled.

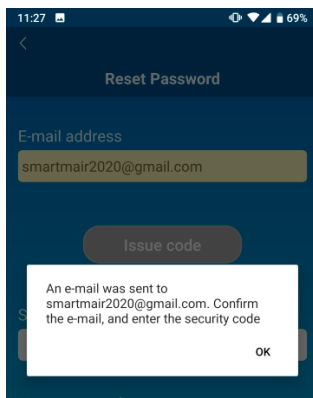

Figure 13-10

When the e-mail sending pop-up message appears, tap [OK].

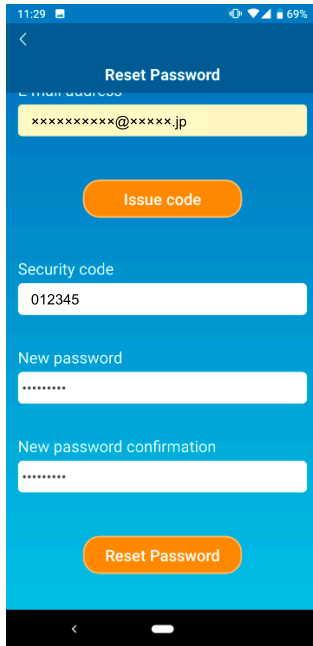

Figure 13-11

An e-mail with a security code will be sent to the e-mail address you entered. Enter “Security code” and “New password” and tap [Reset Password] to update your password.

### Note

- A password must be between 8 to 16 characters including at least one alphabetic character and one numeric character.

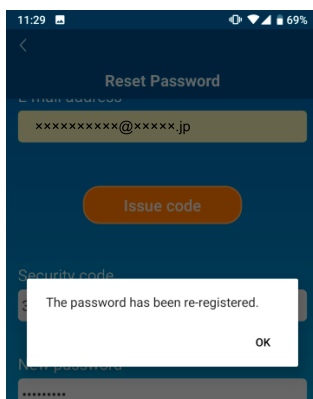

Figure 13-12

- Language/Time Zone Settings

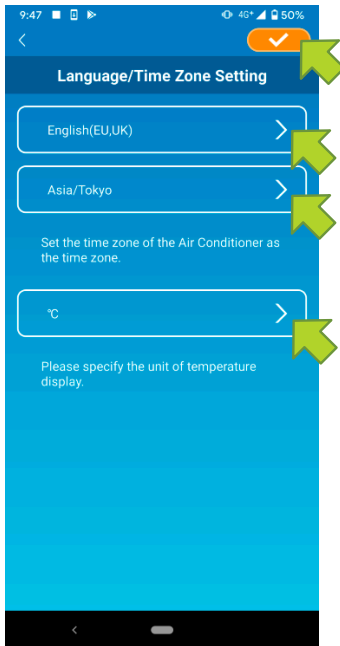



Figure 13-13

The “Language/Time Zone Settings” screen appears.

Select a language to use in the application.

Select a time zone. Select the time zone in which the air conditioner to operate via the application exists.

Choose the unit of temperature.

Finally, tap  on the top right to complete the setting.

- Application Initialization

Initializes the smartphone application.

---

**Note**

- Note that if you initialize the application in “Remote operation mode”, the information of the account logged in is deleted.
- 

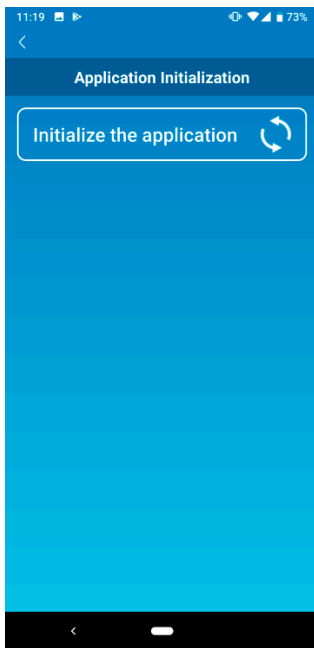

Tap [Initialize the application].

Figure 13-14

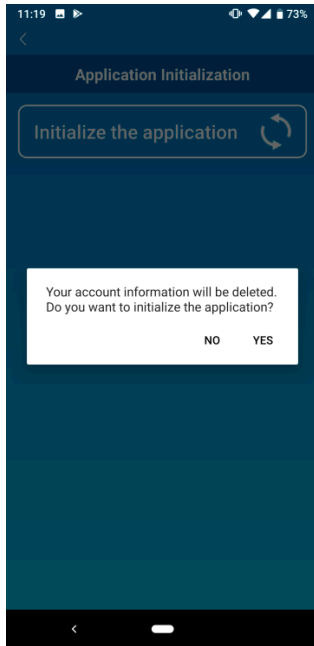

When the pop-up message “Your account information will be deleted. Do you want to initialize the application?” appears, tap [YES].

Figure 13-15

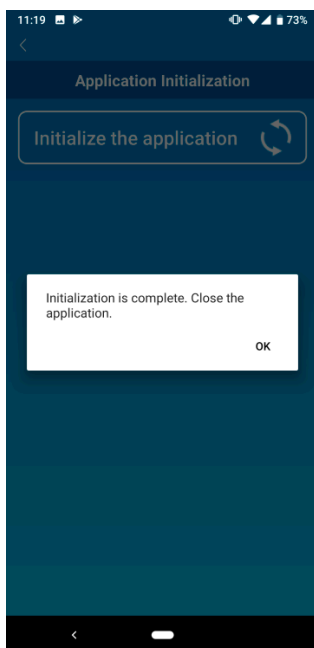

When the pop-up message "Initialization is complete. Close the application." appears, tap [OK] to close the application.

Figure 13-16

- Application Version Display

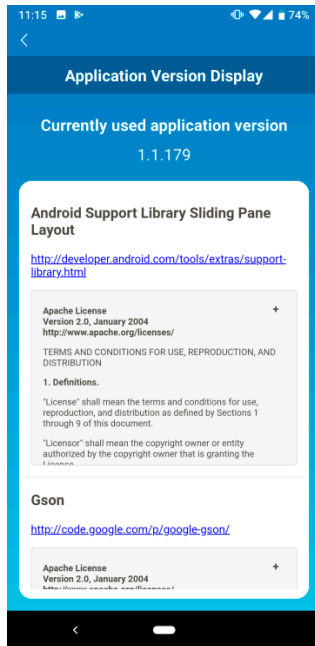

Displays the version of your smartphone application.

Figure 13-17

## (14) Troubleshooting

- When the air conditioner that you want to register does not appear in the air conditioner list screen

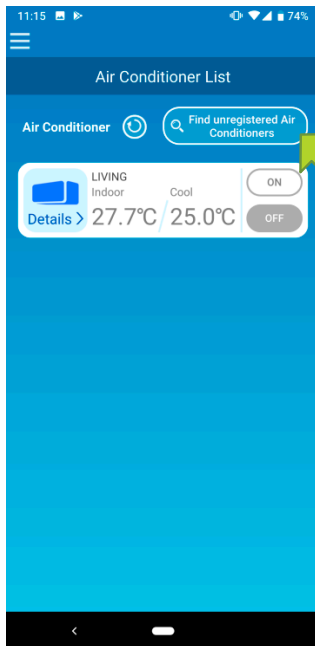

Figure 14-1

Tap the [Find unregistered Air Conditioners]

Button to search unregistered air conditioners and update the "Air Conditioner List" screen.

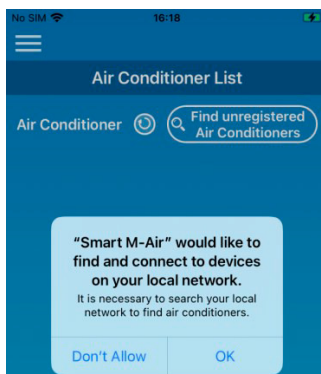

Figure 14-2

When asked for "search your local network" on iOS, tap the "OK" button.

If you accidentally tap the "Don't Allow" button, change the Smart M-Air's "local network" in the iOS app permission settings to "ON", then tap the " Find unregistered Air Conditioner" button again.



- How to delete a registered air conditioner

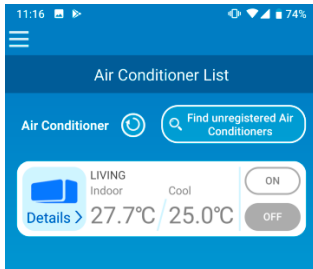

Figure 14-3

To delete a registered air conditioner, press and hold down (2 seconds) the icon of the target air conditioner.

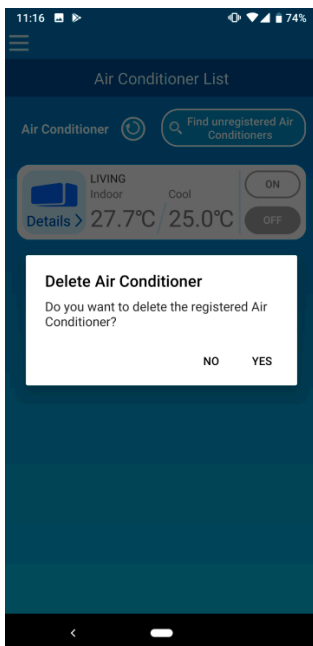

Figure 14-4

When the deleting air conditioner pop-up Message appears, tap [YES].

- When an abnormality notification appears in the air conditioner list

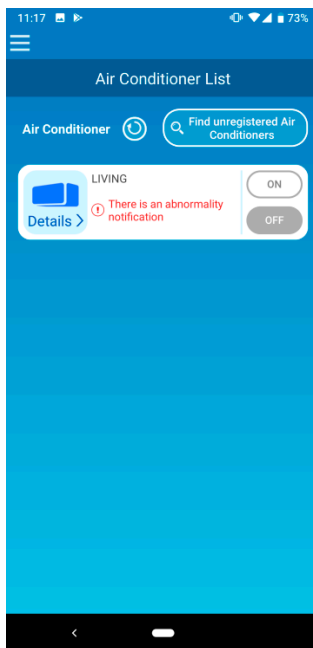

Figure 14-5

When an abnormality notification appears, air conditioner abnormality has been detected. Contact your dealer.

When “AC error notification” of the option settings is enabled, an e-mail is sent to the registered e-mail address.

- When you forget your password and cannot log in

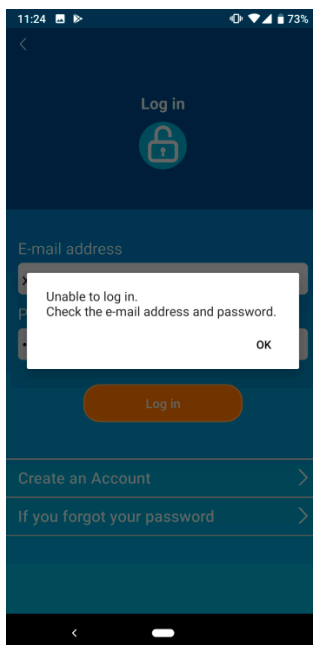

Figure 14-6

If you forgot your password and failed to log in, tap [OK] on the pop-up message, tap [If you forgot your password] to display the “Reset Password” screen, and set a new password.

→ To [“Reset Password”](#)

- When operation is performed by another account

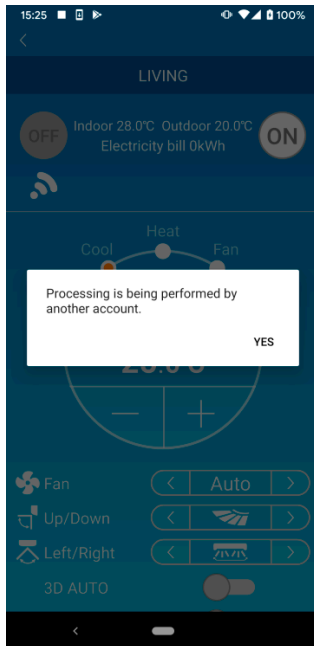

Figure 14-7

The message shows in the following cases:

- When the application is operated from other smartphones at the same time
- When the air conditioner is changing its operation status by its set control

The equipment is not malfunctioning, so please try again after a while.

(Approximately 1 minute)

- When "Shut-off reminder alert" does not turn on  
(For Android OS)

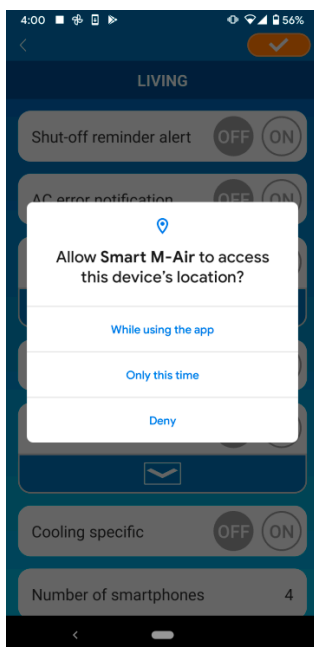

Figure 14-8

You must select "While using the app" when there is a request to allow access to your device information for this application.

If you accidentally tap other buttons such as "Only this time" or "Deny", you can change it to "While using the app" in Android OS Setting Screen.

---

# **INVERTER WALL MOUNTED TYPE RESIDENTIAL AIR-CONDITIONERS**

---



---

**MITSUBISHI HEAVY INDUSTRIES THERMAL SYSTEMS, LTD.**

2-3, Marunouchi 3-chome, Chiyoda-ku, Tokyo, 100-8332, Japan  
<http://www.mhi-mth.co.jp/en/>

Because of our policy of continuous improvement, we reserve the right to make changes in all specifications without notice.

© Copyright MITSUBISHI HEAVY INDUSTRIES THERMAL SYSTEMS, LTD.