

9. OUTLINE OF OPERATION CONTROL BY MICROCOMPUTER

(1) Operation control function by wireless remote control

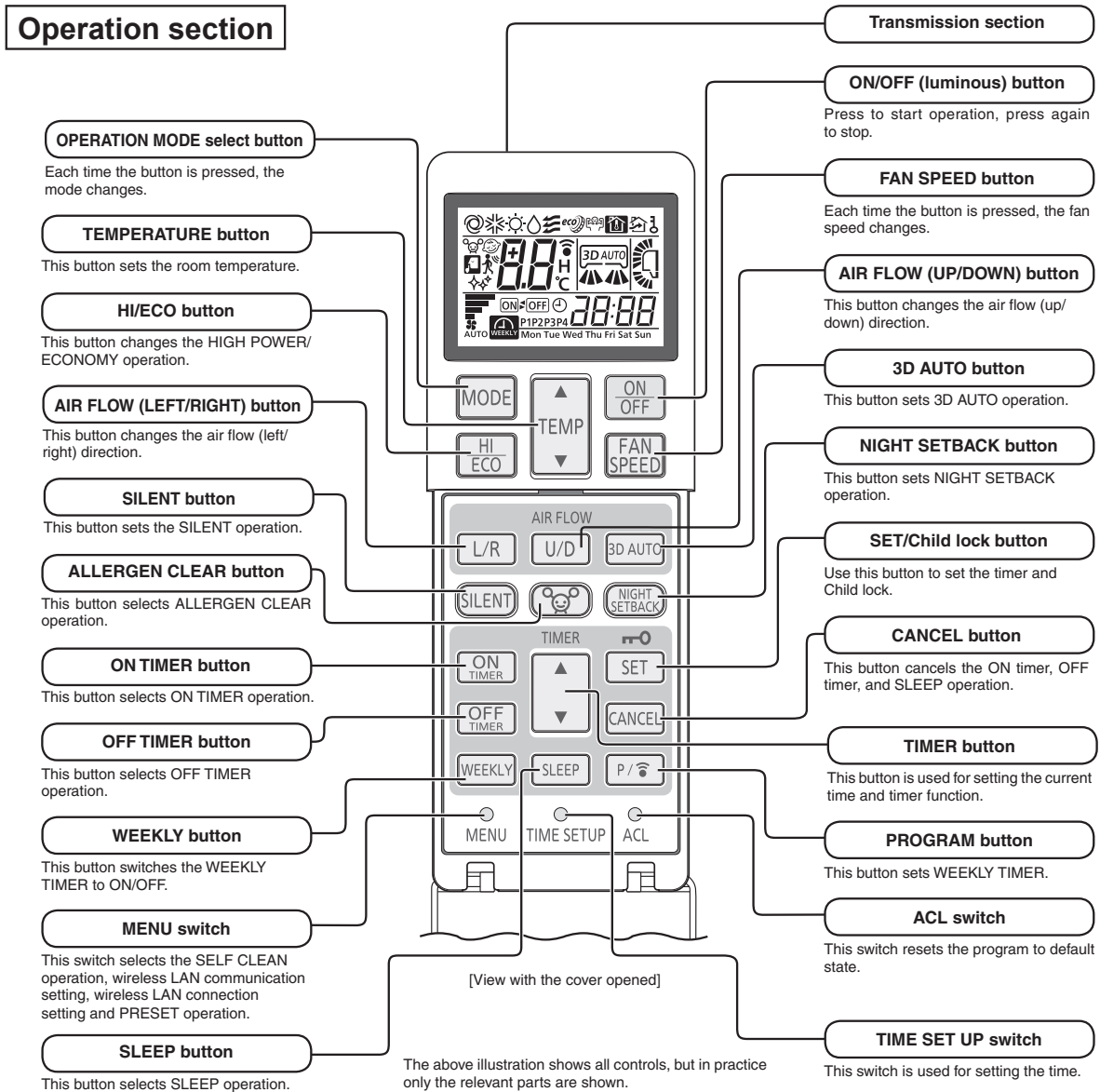

Unit display section

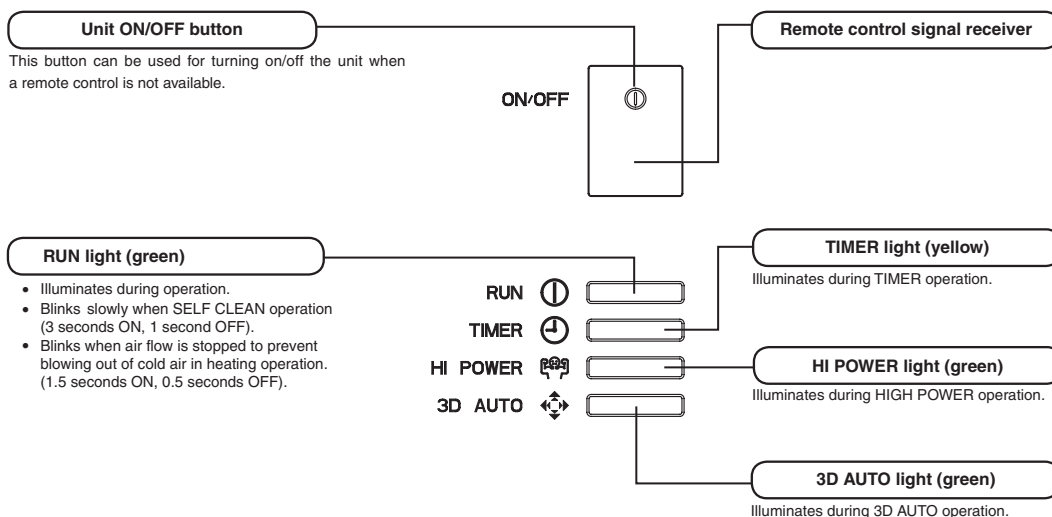

(2) Unit ON/OFF button

When the wireless remote control batteries become weak, or if the wireless remote control is lost or malfunctioning, this button may be used to turn the unit on and off.

(a) Operation

Push the button once to place the unit in the automatic mode. Push it once more to turn the unit off.

(b) Details of operation

The unit will go into the automatic mode in which it automatically determines, from room temperature (as detected by sensor), whether to go into COOL or HEAT modes.

Function	Indoor temperature setting	Fan speed	Flap/Louver	Timer Switch
Operation mode				
COOL	About 24°C	Auto	Auto	Continuous
HEAT	About 26°C			

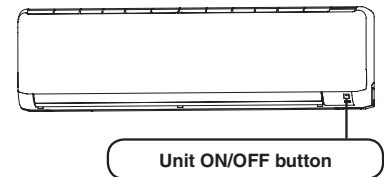

(3) Auto restart function

(a) Auto restart function records the operational status of the air-conditioner immediately prior to be switched off by a power cut, and then automatically resumes operations after the power has been restored.

(b) The following settings will be cancelled:

- (i) Timer settings
- (ii) HIGH POWER operations

- Notes
- (1) Auto restart function is set at on when the air-conditioner is shipped from the factory. Consult with your dealer if this function needs to be switched off.
 - (2) When power failure occurs, the timer setting is cancelled. Once power is resumed, reset the timer.
 - (3) If the jumper wire (JA1) "AUTO RESTART" is cut, auto restart is disabled. (See the diagram at right.)

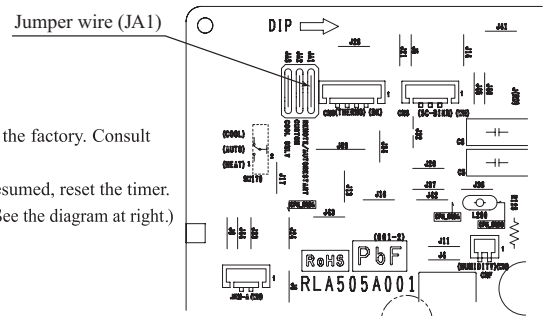

(4) Installing two air-conditioners in the same room

When two air-conditioners are installed in the room, use setting when the two air-conditioners are not operated with one wireless remote control. Set the wireless remote control and indoor unit.

(a) Setting the wireless remote control

- (i) Pull out the cover and take out batteries.
- (ii) Disconnect the switching line next to the battery with wire cutters.
- (iii) Insert batteries, Close the cover.

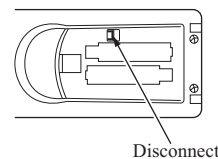

(b) Setting an indoor unit

- (i) Turn off the power source and turn it on after 1 minute.
- (ii) Point the wireless remote control (that was set according to the procedure described on the left side) at the indoor unit and send a signal by pressing the ACL switch on the wireless remote control.
Since the signal is sent in about 6 seconds after the ACL switch is pressed, point the wireless remote control at the indoor unit for some time.
- (iii) Check that the reception buzzer sound "Peep" is emitted from the indoor unit. At completion of the setting, the indoor unit emits a buzzer sound "Peep". (If no reception tone is emitted, start the setting from the beginning again.)

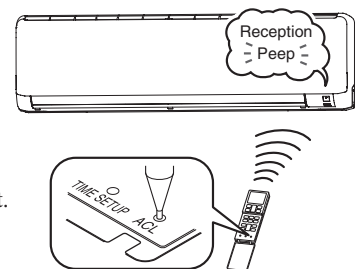

(5) Selection of the annual cooling function

(a) The annual cooling control is valid from factory default setting. It is possible to disable by cutting jumper wire (JA3), or changing the setting of DIP switch (SW2-4) on the interface kit (Option) PCB if it is connected.

Jumper wire (JA3)	Interface kit (SC-BIKN2-E) SW2-4	Function
Shorted	ON	Enabled factory default setting
Shorted	OFF	Disabled
Open	ON	Disabled
Open	OFF	Disabled

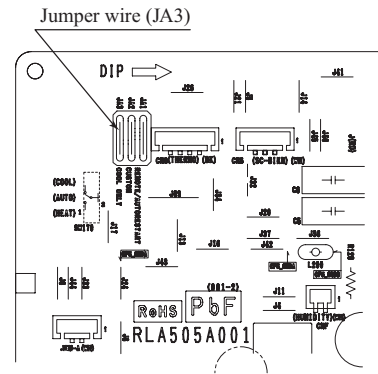

Notes: (1) Default states of the jumper wire (JA3) and the interface kit at the shipping from factory –On the PCB, the DIP switch (SW2-4) is set to enable the annual cooling function.

(2) To cancel the annual cooling setting, consult your dealer.

(b) Content of control

- (i) If the outdoor air temperature sensor (TH2) detects below 5°C, the indoor fan speed is switched to 8th step. (It is not possible to change.)
- (ii) If the outdoor air temperature sensor (TH2) detects higher than 7°C, the indoor fan speed is changed to the normal control speed.

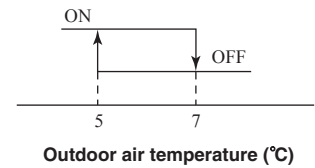

(6) High power operation

Pressing the HI/ECO button intensifies the operating power and initiates powerful cooling or heating operation for 15 minutes continuously. The wireless remote control displays HIGH POWER mark and the FAN SPEED display disappears.

- (a) During the HIGH POWER operation, the room temperature is not controlled. When it causes an excessive cooling or heating, press the HI/ECO button again to cancel the HIGH POWER operation.
- (b) HIGH POWER operation is not available during dehumidifying and the program timer operations.
- (c) When HIGH POWER operation is set after setting ON TIMER operation, HIGH POWER operation will start from the set time.
- (d) When the following operation are set, HIGH POWER operation will be canceled.
 - ① When the HI/ECO button is pressed again (The operation mode will be changed to the ECONOMY operation.)
 - ② When the operation mode is changed
 - ③ When it has been 15 minutes since HIGH POWER operation has started
 - ④ When the 3D AUTO button is pressed
 - ⑤ When the SILENT button is pressed
 - ⑥ When the NIGHT SETBACK button is pressed
- (e) Not operable while the air-conditioner is OFF.
- (f) After HIGH POWER operation, the sound of refrigerant flowing may be heard.

(7) Economy operation

Pressing the HI/ECO button initiate a soft operation with the power suppressed in order to avoid an excessive cooling or heating. The unit operates 1.5°C higher than the setting temperature during cooling or 2.5°C lower than that during heating. The wireless remote control displays ECONO mark and the FAN SPEED display disappears.

- (a) It will go into ECONOMY operation at the next time the air-conditioner runs in the following cases.
 - ① When the air-conditioner is stopped by ON/OFF button during ECONOMY operation
 - ② When the air-conditioner is stopped in SLEEP or OFF TIMER operation during ECONOMY operation
 - ③ When the operation is retrieved from SELF CLEAN or ALLERGEN CLEAR operation
- (b) When the following operation are set, ECONOMY operation will be canceled.
 - ① When the HI/ECO button is pressed again
 - ② When the operation mode is changed from DRY to FAN
 - ③ When the NIGHT SETBACK button is pressed
- (c) Not operable while the air-conditioner is OFF.

(d) The setting temperature is adjusted according to the following table.

(Unit : deg°C)

Item \ Mode		Cooling	Heating
Temperature adjustment	①	+0.5	-1.0
	②	+1.0	-2.0
	③	1.0 + Figure A	-2.0 + Figure B

- ① at the start of operation.
- ② one hour after the start of operation.
- ③ two hours after the start of operation.

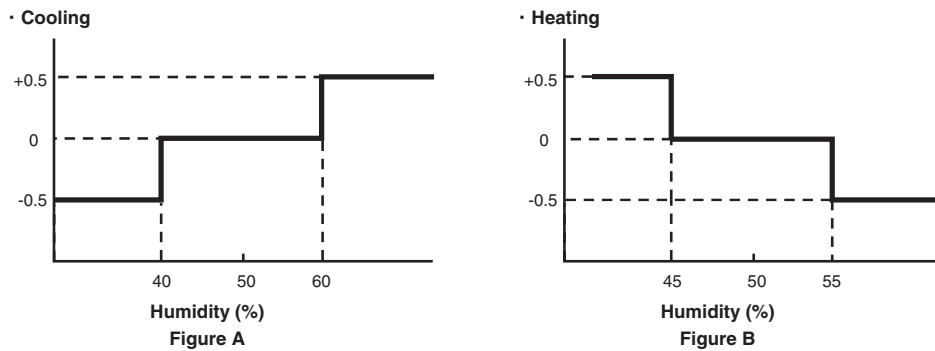

(8) Air flow direction adjustment

Air flow direction can be adjusted with by AIR FLOW U/D (UP/DOWN) and L/R (LEFT/RIGHT) button on the wireless remote control.

(a) Flap

Each time when you press the AIR FLOW U/D (UP/DOWN) button the mode changes as follows.

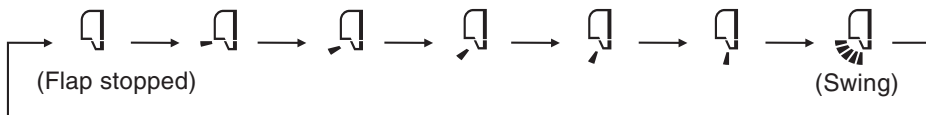

• Angle of Flap from Horizontal

Remote control display					
COOL , DRY, FAN	Approx. 5°	Approx. 20°	Approx. 35°	Approx. 50°	Approx. 70°
HEAT	Approx. 20°	Approx. 35°	Approx. 45°	Approx. 60°	Approx. 70°

(b) Louver

Each time when you press the AIR FLOW L/R (LEFT/RIGHT) button the mode changes as follows.

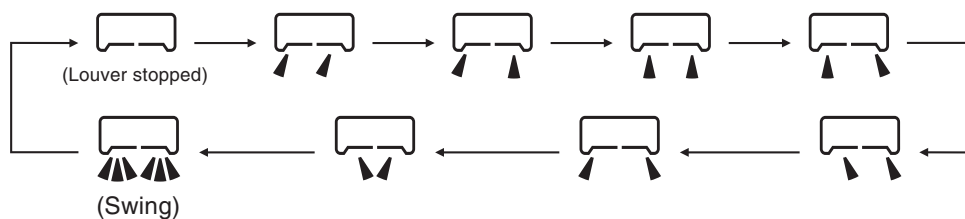

• Angle of Louver

Remote control display					
Center installation	Left approx. 50°	Left approx. 20°	Center	Right approx. 20°	Right approx. 50°
Right end installation	Left approx. 50°	Left approx. 45°	Left approx. 30°	Center	Right approx. 20°
Left end installation	Left approx. 20°	Center	Right approx. 30°	Right approx. 45°	Right approx. 50°

(c) Swing

(i) Swing flap

Flap moves in upward and downward directions continuously.

◆ In HEAT operation

◆ In COOL, DRY, FAN operation

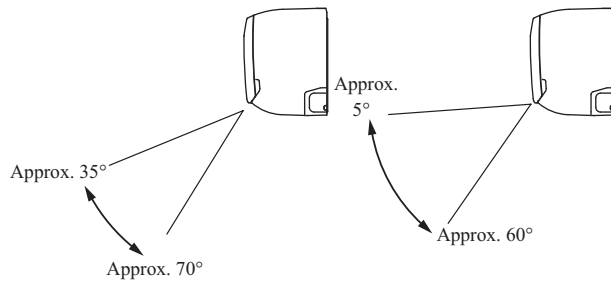

(ii) Swing louver

Louver moves in left and right directions continuously.



(d) Memory flap (Flap or Louver stopped)

When you press the AIR FLOW (UP/DOWN or LEFT/RIGHT) button once while the flap or louver is operating, it stops swinging at the position. Since this angle is memorized in the microcomputer, the flap or louver will automatically be set at this angle when the next operation is started.

(e) When not operating

The flap returns to the position of air flow directly below, when operation has stopped.

(9) 3D auto operation

Control the flap and louver by 3D AUTO button on the wireless remote control.

Fan speed and air flow direction are automatically controlled, allowing the entire room to efficiently conditioned.

(a) During cooling and heating (Including auto cooling and heating)

(i) Air flow selection is determined according to indoor temperature and setting temperature.

Operation mode	Air flow selection					
	AUTO		HI	MED	LO	ULO
Cooling	Room temp. – Setting temp. >5°C	Room temp. – Setting temp. ≤ 5°C	HI	MED	LO	ULO
	HIGH POWER	AUTO				
Heating	Setting temp. – Room temp. >5°C	Setting temp. – Room temp. ≤ 5°C				
	HIGH POWER	AUTO				

(ii) Air flow direction is controlled according to the room temperature and setting temperature.

1) When 3D auto operation starts

	Cooling	Heating
Flap	Up/down swing	
Louver	Wide (Fixed)	Center (Fixed)

2) When Room temp. – Setting temp. is ≤ 5°C during cooling and when Setting temp. – Room temp. is ≤ 5°C during heating, the system switches to the following air flow direction control. After the louver swings left and right symmetrically for 3 cycles, control is switched to the control in 3).

	Cooling	Heating
Flap	Horizontal blowing (Fixed)	Slant forward blowing (Fixed)
Louver	Left/right swing	

3) After the flap swings for 5 cycles, control is switched to the control in 4).

	Cooling	Heating
Flap	Up/down swing	
Louver	Center (Fixed)	

- 4) For 5 minutes, the following air flow direction control is carried out.

	Cooling	Heating
Flap	Horizontal blowing (Fixed)	Slant forward blowing (Fixed)
Louver	Wide (Fixed)	

- 5) After 5 minutes have passed, the air flow direction is determined according to the indoor temperature and setting temperature.

Operation mode	Air flow direction control		
Cooling	Room temp. – Setting temp. $\leq 2^{\circ}\text{C}$	$2^{\circ}\text{C} < \text{Room temp.} - \text{Setting temp.} \leq 5^{\circ}\text{C}$	Room temp. – Setting temp. $> 5^{\circ}\text{C}$
	The control in 4) continues.	Control returns to the control in 2).	Control returns to the control in 1).
Heating	Setting temp. – Room temp. $\leq 2^{\circ}\text{C}$	$2^{\circ}\text{C} < \text{Setting temp.} - \text{Room temp.} \leq 5^{\circ}\text{C}$	Setting temp. – Room temp. $> 5^{\circ}\text{C}$
	The control in 4) continues.	Control returns to the control in 2).	Control returns to the control in 1).

- (b) During dehumidifying operation (including auto dehumidifying operation)

Flap	Horizontal blowing (Fixed)
Louver	Wide (Fixed)

(10) Timer operation

(a) Comfortable timer setting (ON timer)

The unit starts the operation 5 to 60 minutes earlier so that the room can approach optimum temperature at ON timer.

(b) Sleep timer operation

Pressing the SLEEP button causes the temperature to be controlled with respect to the set temperature.

(c) OFF timer operation

The Off timer can be set at a specific time (in 10-minute units) within a 24-hour period.

(d) Weekly timer operation

Timer operation (ON timer, OFF timer) can be set up to 4 times a day for each weekday.

Note Timer operation from wireless remote control becomes invalid when you connect the interface kit (such as SC-BIKN2-E).

(e) Combination of patterns which can be set for the timer operations

Item	Sleep timer	OFF timer	ON timer	Weekly timer
Sleep timer		×	○	×
OFF timer	×		○	×
ON timer	○	○		×
Weekly timer	×	×	×	

Notes (1) ○: Allowed ×: Not

(2) Since the ON timer, Sleep timer and OFF timer are set in parallel, when the times to turn ON and OFF the air-conditioner are duplicated, the setting of the OFF timer has priority.

(11) Silent operation

As “Silent mode start” signal is received from the wireless remote control, it operates by dropping the outdoor fan tap and the compressor command speed.

	SRK63ZR-WF	SRK71ZR-WF	SRK80ZR-WF
Outdoor fan tap (Upper limit)	5th speed	3rd speed	3rd speed
Compressor command speed	48 rps	50 rps	54 rps

(12) Night setback operation

As “Night setback” signal is received from the wireless remote control, the heating operation starts with the setting temperature at 10°C .

(13) Air flow range setting

When the indoor unit is installed at the end of a room, control the air flow direction so that it is not toward the side walls. If you set the wireless remote control installation position, keep it so that the air flow is within the range shown in the following figure.

(a) Setting

- (i) If the air-conditioning unit is running, press the ON/OFF button to stop.**

The air flow range setting cannot be made while the unit is running.

- (ii) Press the AIR FLOW U/D (UP/DOWN) button and the AIR FLOW L/R (LEFT/RIGHT) button together for 5 seconds or more.**

The air flow range setting display illuminates.

- (iii) Setting the air-conditioning installation location.**

Press the AIR FLOW L/R (LEFT/RIGHT) button and adjust to the desired location.

Each time the AIR FLOW L/R (LEFT/RIGHT) button is pressed, the display is switched in the order of:

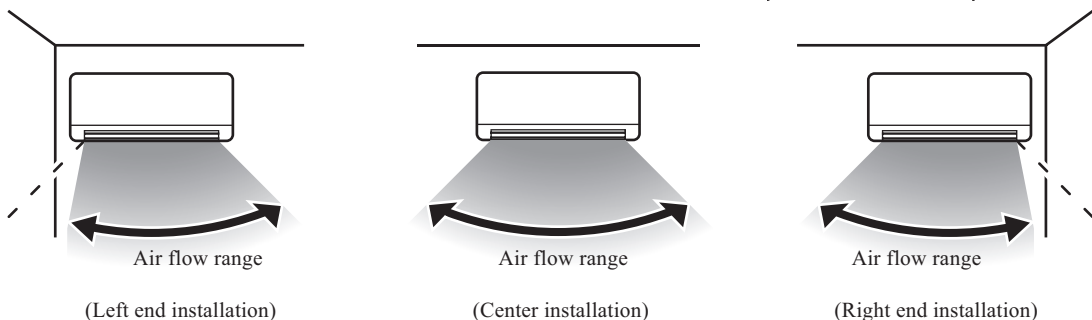
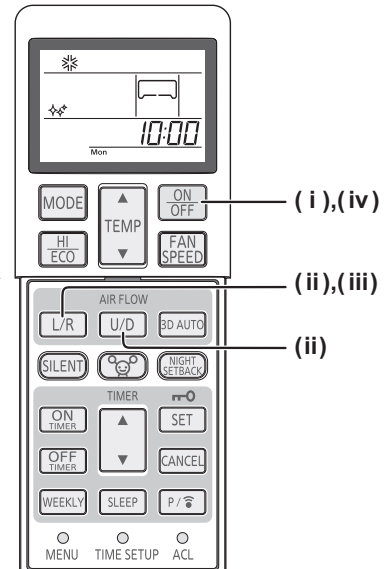

- (iv) Press the ON/OFF button.**

The air-conditioner's air flow range is set.

Press within 60 seconds of setting the air flow range (while the air flow range setting display illuminates).

(14) Wireless LAN connection function

(a) Operating conditions

When a signal of wireless LAN connection setting was received from a remote control during all air-conditioners stop

(b) Detail of operation

- (i) A signal which corresponds to the signal received from a remote control is sent to air-conditioner.
- (ii) A buzzer for confirmation of receipt rings.

(c) Reset conditions

When either of the following conditions is satisfied

- (i) When a reception complete signal was received from interface
- (ii) When an interface communication setting OFF signal was received from a remote control

(15) Outline of heating operation

(a) Operation of major functional components in heating mode

	Heating		
	Thermostat ON	Thermostat OFF	Failure
Compressor	ON	OFF	OFF
Indoor fan motor	ON	ON(HOT KEEP)	OFF
Outdoor fan motor	ON	OFF (few minutes ON)	OFF
4-way valve	ON	ON	OFF (3 minutes ON)

(b) Details of control at each operation mode (pattern)

(i) Fuzzy operation

Deviation between the indoor temperature setting correction temperature and the return air temperature is calculated in accordance with the fuzzy rule, and used for control of the air capacity and the compressor speed.

Model	SRK63ZR-WF	SRK71ZR-WF	SRK80ZR-WF
Fan speed			
AUTO	12-120rps	20-116rps	20-120rps
HI	12-120rps	20-116rps	20-120rps
MED	12-120rps	20-116rps	20-120rps
LO	12-94rps	20-78rps	20-86rps
ULO	12-54rps	20-46rps	20-52rps

When the defrost operation, protection device, etc. is actuated, operation is performed in the corresponding mode.

(ii) Hot keep operation

If the hot keep operation is selected during the heating operation, the indoor fan motor is controlled based on the temperature of the indoor heat exchanger (Th2) to prevent blowing of cool wind.

(c) Defrost operation

(i) Starting conditions (Defrost operation can be started only when all of the following conditions are satisfied.)

- 1) After start of heating operation
When it elapsed 35 minutes (Accumulated compressor operation time)
- 2) After end of defrost operation
When it elapsed 35 minutes (Accumulated compressor operation time)
- 3) Outdoor heat exchanger sensor (TH1) temperature
When the temperature has been below -5°C for 3 minutes continuously
- 4) The difference between the outdoor air sensor temperature and the outdoor heat exchanger sensor temperature (TH2-TH1)
 - The outdoor air temperature $\geq -2^\circ\text{C} : 7^\circ\text{C}$ or higher
 - $-15^\circ\text{C} \leq$ The outdoor air temperature $< -2^\circ\text{C} : 4/15 \times$ The outdoor air temperature $+ 7^\circ\text{C}$ or higher
 - The outdoor air temperature $< -15^\circ\text{C} : -5^\circ\text{C}$ or higher

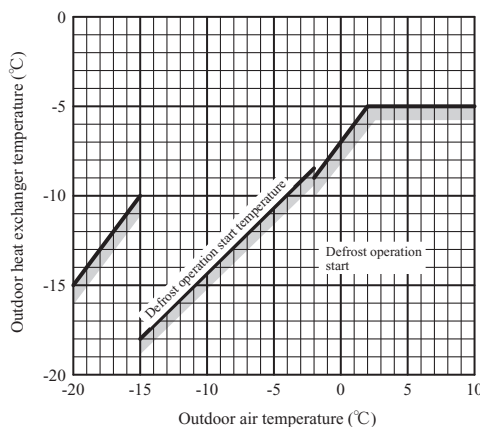

5) During continuous compressor operation

In addition, when the speed command from the indoor control of the indoor unit during heating operation has counted 0 rps 10 times or more and all conditions of 1), 2) above and the outdoor air temperature is 3°C or less are satisfied (note that when the temperature for outdoor heat exchanger sensor (TH1) is -5°C or less: 62 rps or more, -4°C or less: less than 62 rps), defrost operation is started.

(ii) Ending conditions (Operation returns to the heating cycle when either one of the following is satisfied.)

- 1) Outdoor heat exchanger sensor (TH1) temperature: 13°C (model SRK63 : 10°C) or higher
- 2) Continued operation time of defrost operation → For more than 15 minutes.

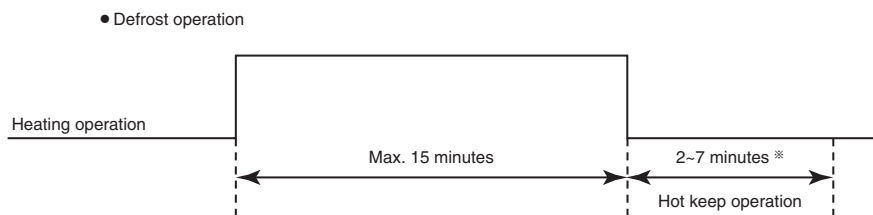

※Depends on an operation condition, the time can be longer than 7 minutes.

(16) Outline of cooling operation

(a) Operation of major functional components in cooling mode

	Cooling		
	Thermostat ON	Thermostat OFF	Failure
Compressor	ON	OFF	OFF
Indoor fan motor	ON	ON	OFF
Outdoor fan motor	ON	OFF (few minutes ON)	OFF (few minutes ON)
4-way valve	OFF	OFF	OFF

(b) Detail of control in each mode (Pattern)

1) Fuzzy operation

During the fuzzy operation, the air flow and the compressor speed are controlled by calculating the difference between the indoor temperature setting correction temperature and the return air temperature.

Fan speed	Model	SRK63ZR-WF	SRK71ZR-WF	SRK80ZR-WF
	AUTO		12-106rps	20-76rps
HI		12-106rps	20-76rps	20-98rps
MED		12-68rps	20-56rps	20-64rps
LO		12-50rps	20-40rps	20-46rps
ULO		12-32rps	20-26rps	20-26rps

(17) Outline of dehumidifying (DRY) operation

(a) Purpose of DRY mode

The purpose is "Dehumidification", and not to control the humidity to the target condition.

Indoor/outdoor unit control the operation condition to reduce the humidity, and also prevent over cooling.

(b) Outline of control

(i) Indoor fan speed and compressor are controlled by the area which is selected by the temperature difference.

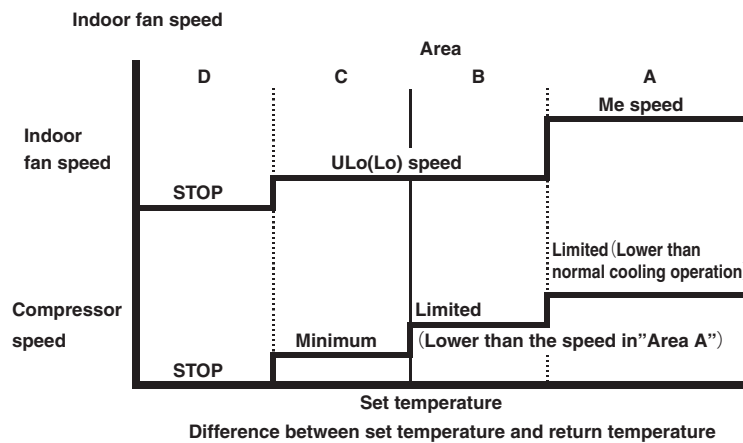

(ii) The indoor unit check the current area by every 5 minutes, and operate by the next checking.

(c) Other

When the outside temperature and room temperature is low for cooling operation, indoor unit can not operate in cooling, and dehumidifying. In this case, the units operate in heating to rise the room temperature and after that start dehumidifying operation.

(18) Outline of automatic operation

(a) Determination of operation mode

Operation mode is determined by indoor air temperature and outdoor air temperature as following.

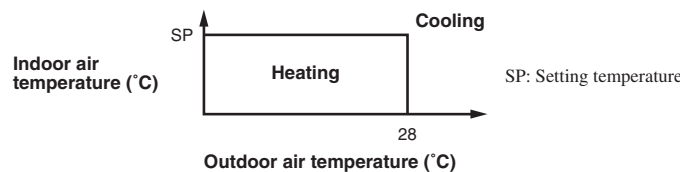

(b) Operation mode is changes when keep cooling and heating thermostat off 20 minutes and be satisfied with following conditions. If the setting temperature is changed with the remote control, the operation mode is judged immediately.

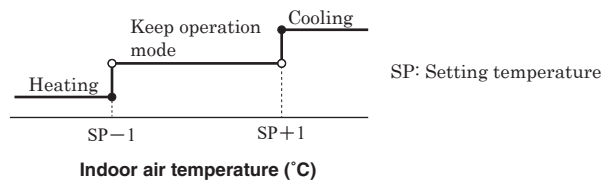

※It can not be changed to heating mode if outdoor air temperature is 28°C or higher.

- (c) When the unit is started again within one hour after the stop of automatic operation or when the automatic operation is selected during heating, cooling or DRY mode, the unit is operated in the previous operation mode.
- (d) Setting temperature can be adjusted within the following range. There is the relationship as shown below between the signals of the wireless remote control and the setting temperature.

Unit : °C

		Signals of wireless remote control (Display)												
		18	19	20	21	22	23	24	25	26	27	28	29	30
Setting temperature	Cooling	20	21	22	23	24	25	26	27	28	29	30	31	32
	Heating	19	20	21	22	23	24	25	26	27	28	29	30	31

(19) Protection control function

(a) Dew prevention control [Cooling]: Prevents dewing on the indoor unit.

(i) Operating conditions

When the following conditions have been satisfied for more than 30 minutes after starting operation.

- 1) Compressor's command speed is 28 rps or higher.
- 2) Detected value of humidity is 68% or higher.

(ii) Contents of operation

1) Air capacity control

Item	Model	SRK63ZR-WF	SRK71ZR-WF	SRK80ZR-WF
Upper limit of compressor's command speed ⁽¹⁾	Range A	Follow the table below		
	Range B	40rps	40rps	45rps

Note (1) Ranges A and B are as shown below.

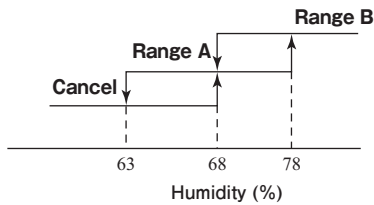

● Condition for Range A

Compressor's command speed is controlled according to the indoor unit heat exchanger temperature (Th2) and the indoor unit room temperature (Th1).

Condition	Compressor's command speed
$Th2 \leq Th1 - 10$	<ul style="list-style-type: none"> Decreases the compressor's target max speed by 4 rps. If the condition is satisfied still 20 seconds later, the speed is decreased further by 4 rps. This process is repeated further so far as the condition is met. (Lower limit is 30 rps.)
$Th1 - 10 < Th2 \leq Th1 - 6$	Compressor's target max. speed or changed value of the same is maintained.
$Th1 - 6 < Th2$	Changed compressor's target max. speed is increased at a rate of 1 rps/20 seconds.

- 2) When this control has continued for more than 30 minutes continuously, the following wind direction control is performed.
- When the vertical wind direction is set at other than the vertical swing, the flaps change to the horizontal position.
 - When the horizontal wind direction is set at other than the horizontal swing, the louver changes to the vertical position.

(iii) Reset conditions

When any of followings is satisfied

- Compressor's command speed is less than 28 rps.
- Detected value of humidity is less than 63%.

(b) Frost prevention control (During cooling or dehumidifying)

(i) Operating conditions

- Indoor heat exchanger temperature (Th2) is lower than 5°C.
- 5 minutes after reaching the compressor command speed except 0 rps.

(ii) Detail of anti-frost operation

Item	Indoor heat exchanger temperature	5°C or lower	2.5°C or lower
Lower limit of compressor command speed		22 rps (model SRK63 : 25rps)	0 rps
Indoor fan		Depends on operation mode	Protects the fan tap just before frost prevention control
Outdoor fan		Depends on command speed	Depends on stop mode
4-way valve		OFF	

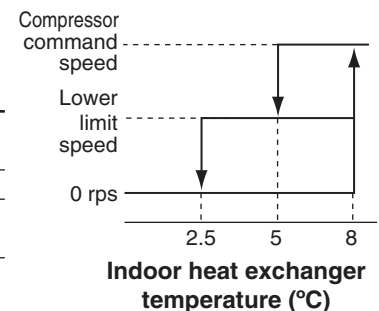

- Notes
- When the indoor heat exchanger temperature is in the range of 2.5-5°C, the speed is reduced by 4 rps at each 20 seconds.
 - When the temperature is lower than 2.5°C, the compressor is stopped.
 - When the indoor heat exchanger temperature is in the range of 5-8°C, the compressor command speed is been maintained.

(iii) Reset conditions

When either of the following condition is satisfied

- The indoor heat exchanger temperature (Th2) is 8°C or higher.
- The compressor command speed is 0 rps.

(c) Cooling overload protective control

(i) Operating conditions:Reset conditions

When the outdoor air temperature (TH2) has become continuously for 30 seconds at 38(37)°C or more, with the compressor running, the lower limit speed of compressor is brought up.

Item	Model	SRK63ZR-WF		
Outdoor air temperature		38°C or more	41°C or more	47°C or more
Lower limit speed		25 rps	30 rps	40 rps

Item	Model	SRK71, 80ZR-WF		
Outdoor air temperature		37°C or more	41°C or more	47°C or more
Lower limit speed		30 rps	35 rps	40 rps

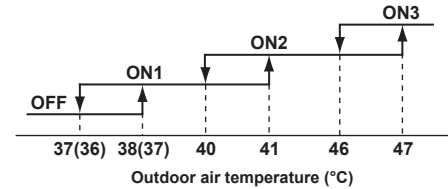

Note(1) Values in () are for the models 71, 80.

(ii) Detail of operation

The lower limit of compressor command speed is set to 25(30), 30(35) or 40 rps and even if the calculated result becomes lower than that after fuzzy calculation, the speed is kept to 25(30), 30(35) or 40 rps. However, when the thermo OFF, the speed is reduced to 0 rps.

(iii) Reset conditions

When either of the following condition is satisfied

- 1) The outdoor air temperature is lower than 37(36) °C.
- 2) The compressor command speed is 0 rps.

(d) Cooling high pressure control

(i) Purpose

Prevents anomalous high pressure operation during cooling

(ii) Detector

Outdoor heat exchanger temperature (TH1)

(iii) Detail of operation

(Example) Fuzzy

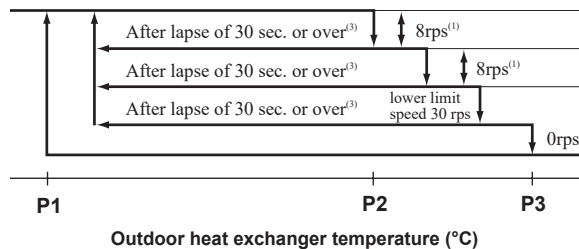

• Model 63 Unit : °C

	P1	P2	P3
Range A	53	58	62
Range B	48	52	55
Range C	44	45.5	47

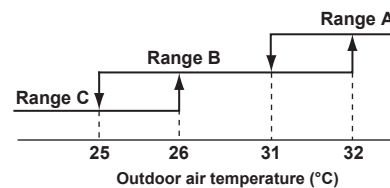

• Model 71 Unit : °C

	P1	P2	P3
Range A	53	58	61
Range B	51	53	56
Range C	48	50	56

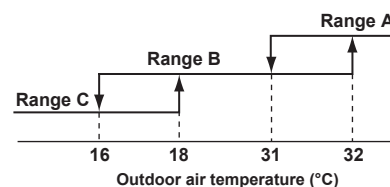

• Model 80 Unit : °C

	P1	P2	P3
Range A	53	58	60
Range B	51	53	56

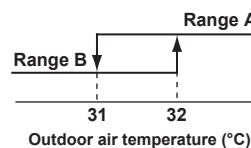

- Notes(1) When the outdoor heat exchanger temperature is in the range of P2 -P3, the speed is reduced by 8 rps at each 20 seconds.
 (2) When the temperature is P3 or higher, the compressor is stopped.
 (3) When the outdoor heat exchanger temperature is in the range of P1 -P2, if the compressor command speed is been maintained and the operation has continued for more than 30 seconds at the same speed, it returns to the normal cooling operation.

(e) Cooling low outdoor air temperature protective control

(i) Operating conditions

When the outdoor air temperature (TH2) is 22°C or lower continues for 20 seconds while the compressor command speed is other than 0 rps.

(ii) Detail of operation

- 1) The lower limit of the compressor command speed is set to B (D) rps and even if the speed becomes lower than 40 (30) rps, the speed is kept to 40 (30) rps. However, when the thermo OFF, the speed is reduced to 0 rps.
- 2) The upper limit of the compressor command speed is set to A (C) rps and even if the calculated result becomes higher than that after fuzzy calculation, the speed is kept to A (C) rps.

Note(1) Values () are for outdoor air temperature is 0°C.

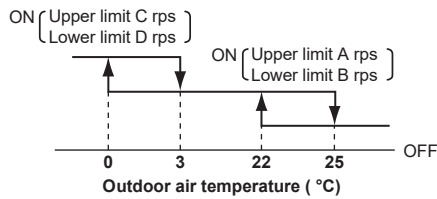

● Compressor command speed (Unit : rps)

	A	B		C	D
		B-1	B-2		
Model 63	70	35	Cancel	60	60
Model 71, 80	75	30	Cancel	60	40

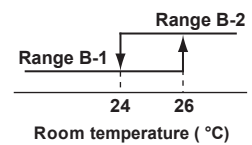

(iii) Reset conditions

When either of the following condition is satisfied

- 1) The outdoor air temperature (TH2) is 25°C or higher.
- 2) The compressor command speed is 0 rps.

(f) Heating high pressure control

(i) Purpose

Prevents anomalous high pressure operation during heating

(ii) Detector

Indoor heat exchanger temperature (Th2)

(iii) Detail of operation

(Example) Fuzzy

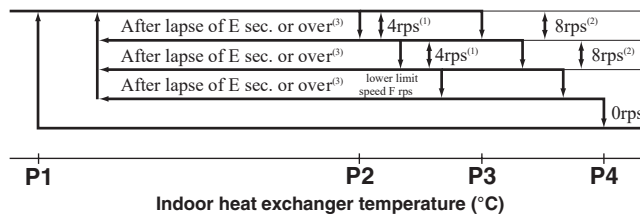

	E	F
Model 63	10	35
Models 71, 80	20	30

- Notes
- (1) When the indoor heat exchanger temperature is in the range of P2-P3°C, the speed is reduced by 4 rps at each E seconds.
 - (2) When the indoor heat exchanger temperature is in the range of P3-P4°C, the speed is reduced by 8 rps at each E seconds. When the temperature is P4°C or higher continues for 5 seconds, the compressor is stopped.
 - (3) When the indoor heat exchanger temperature is in the range of P1-P2°C, if the compressor command speed is been maintained and the operation has continued for more than E seconds at the same speed, it returns to the normal heating operation.
 - (4) Indoor fan retains the fan speed when it enters in the high pressure control. Outdoor fan is operated in accordance with the speed.

● Temperature list

Model SRK63ZR-WF

Unit : °C

	P1	P2	P3	P4
RPSmin < 45	45	52	54.5 - 56	56.5
45 ≤ RPSmin < 115	45	52	56	57.0
115 ≤ RPSmin < 120	45 - 43	52 - 50	56 - 55	56.5
120 ≤ RPSmin	43	50	55	56.5

Models SRK71, 80ZR-WF

Unit : °C

	P1	P2	P3	P4
RPSmin ≤ 50	45	52	57	57.5
50 < RPSmin < 90	45	52	57	58
90 ≤ RPSmin < 108	45 - 44	52 - 48	57 - 52	56.5
108 ≤ RPSmin < 120	44 - 43	48 - 45	52 - 48	51.5
120 ≤ RPSmin	43	45	48	51.5

Note (1) RPSmin: The lower one between the outdoor speed and the compressor command speed.

(g) Heating overload protective control

(i) Indoor unit side

1) Operating conditions

When the outdoor air temperature (TH2) is 17°C or higher continues for 30 seconds while the compressor command speed other than 0 rps.

2) Detail of operation

The indoor fan is stepped up by 1 speed step. (Upper limit 10th speed)

3) Reset conditions

The outdoor air temperature (TH2) is lower than 16°C.

(ii) Outdoor unit side

1) Operating conditions

When the outdoor air temperature (TH2) is 13°C or 17°C or higher continues for 30 seconds while the compressor command speed other than 0 rps.

2) Detail of operation

- a) Taking the upper limit of compressor command speed range at 90 rps or 50 (75) rps, if the output speed obtained with the fuzzy calculation exceeds the upper limit, the upper limit value is maintained.
- b) The lower limit of compressor command speed is set to 30 rps or 40 rps and even if the calculated result becomes lower than that after fuzzy calculation, the speed is kept to 30 rps or 40 rps. However, when the thermo OFF, the speed is reduced to 0 rps.
- c) Inching prevention control is activated and inching prevention control is carried out with the minimum speed set at 30 rps or 40 rps.

3) Reset conditions

The outdoor air temperature (TH2) is lower than 11°C.

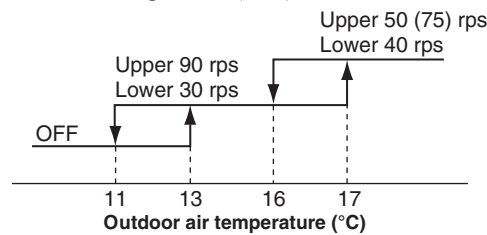

Note(1) Values in () are for the model SRK63.

(h) Heating low outdoor temperature protective control

(i) Operating conditions

When the outdoor air temperature (TH2) is lower than 4°C or higher continues for 30 seconds while the compressor command speed is other than 0 rps

(ii) Detail of operation

The lower limit compressor command speed is change as shown in the figure below.

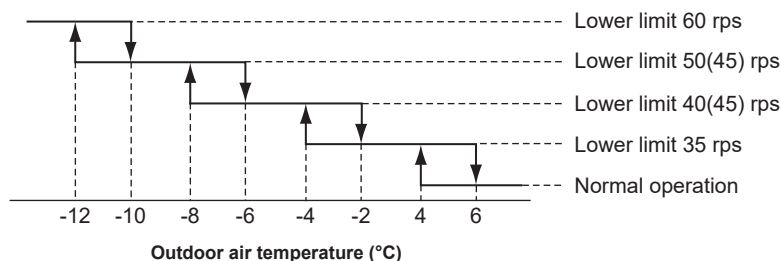

Note(1) Values in () are for the model SRK63.

(iii) Reset conditions

When either of the following condition is satisfied

- 1) The outdoor air temperature (TH2) becomes 6°C.
- 2) The compressor command speed is 0 rps.

(i) Compressor overheat protection

(i) Purpose

It is designed to prevent deterioration of oil, burnout of motor coil and other trouble resulting from the compressor overheat.

(ii) Detail of operation

1) Speeds are controlled with temperature detected by the sensor (TH3) mounted on the discharge pipe.

(Example) Fuzzy

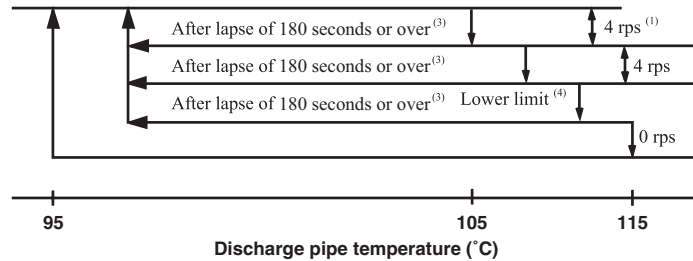

- Notes (1) When the discharge pipe temperature is in the range of 105-115°C, the speed is reduced by 4 rps.
 (2) When the discharge pipe temperature is raised and continues operation for 20 seconds without changing, then the speed is reduced again by 4 rps.
 (3) If the discharge pipe temperature is in the range of 95-105°C even when the compressor command speed is maintained for 180 seconds when the temperature is in the range of 95-105°C, the speed is raised by 1 rps and kept at that speed for 180 seconds. This process is repeated until the command speed is reached.
 (4) Lower limit speed

Model	Item	Cooling	Heating
		Lower limit speed	25 rps

2) If the temperature of 115°C is detected by the sensor on the discharge pipe, then the compressor will stop immediately. When the discharge pipe temperature drops and the time delay of 3 minutes is over, the unit starts again within 1 hour but there is no start at the third time.

(j) Current safe

(i) Purpose

Current is controlled not to exceed the upper limit of the setting operation current.

(ii) Detail of operation

Input current to the converter is monitored with the current sensor fixed on the printed circuit board of the outdoor unit and, if the operation current value reaches the limiting current value, the compressor command speed is reduced. If the mechanism is actuated when the compressor command speed is less than 30 rps, the compressor is stopped immediately. Operation starts again after a delay time of 3 minutes.

(k) Current cut

(i) Purpose

Inverter is protected from overcurrent.

(ii) Detail of operation

Output current from the inverter is monitored with a shunt resistor and, if the current exceeds the setting value, the compressor is stopped immediately. Operation starts again after a delay time of 3 minutes.

(l) Outdoor unit failure

This is a function for determining when there is trouble with the outdoor unit during air-conditioning.

The compressor is stopped if any one of the following in item (i), (ii) is satisfied. Once the unit is stopped by this function, it is not restarted.

- (i) When the input current is measured at 1 A or less for 3 continuous minutes or more.
- (ii) If the outdoor unit sends a 0 rps signal to the indoor unit 3 times or more within 20 minutes of the power being turned on.

(m) Indoor fan motor protection

When the air-conditioner is operating and the indoor fan motor is turned ON, if the indoor fan motor has operated at 300 min^{-1} or under for more than 30 seconds, the unit enters first in the stop mode and then stops the entire system.

(n) Serial signal transmission error protection**(i) Purpose**

Prevents malfunction resulting from error on the indoor ↔ outdoor signals.

(ii) Detail of operation

If the compressor is operating and a serial signal cannot be received from the indoor control with outdoor control having serial signals continues for 7 minutes and 35 seconds, the compressor is stopped.

After the compressor has been stopped, it will be restarted after the compressor start delay if a serial signal can be received again from the indoor control.

(o) Rotor lock

If the motor for the compressor does not turn after it has been started, it is determined that a compressor lock has occurred and the compressor is stopped.

(p) Outdoor fan motor protection

If the outdoor fan motor has operated at 75 min^{-1} or under for more than 30 seconds, the compressor and fan motor are stopped.

(q) Outdoor fan control at low outdoor temperature**(i) Cooling****1) Operating conditions**

When the outdoor air temperature (TH2) is 22°C or lower continues for 30 seconds while the compressor command speed is other than 0 rps.

2) Detail of operation

After the outdoor fan operates at A speed for 60 seconds; the corresponding outdoor heat exchanger temperature shall implement the following controls.

● Value of A

	Outdoor fan
Outdoor air temperature $> 10(0)^\circ\text{C}$	2nd speed
Outdoor air temperature $\leq 10(0)^\circ\text{C}$	1st speed

Note (1) Values in () are for the model SRK63.

a) Outdoor heat exchanger temperature (TH1) $\leq 22^\circ\text{C}$

After the outdoor fan speed drops (down) to 1 speed for 60 seconds; if the outdoor heat exchanger temperature is lower than 22°C , gradually reduce the outdoor fan speed by 1 speed.

● Lower limit fan speed

	Outdoor fan
Outdoor air temperature $> 16(0)^\circ\text{C}$	2nd speed
Outdoor air temperature $\leq 16(0)^\circ\text{C}$	1st speed

Note (1) Values in () are for the model SRK63.

b) $22^\circ\text{C} < \text{Outdoor heat exchanger temperature (TH1)} \leq 40^\circ\text{C}$

After the outdoor fan speed maintains at A speed for 20 seconds; if the outdoor heat exchanger temperature is $22^\circ\text{C} - 40^\circ\text{C}$, maintain outdoor fan speed.

c) Outdoor heat exchanger temperature (TH1) $> 40^\circ\text{C}$

After the outdoor fan speed rises (up) to 1 speed for 60 seconds; if the outdoor heat exchanger temperature is higher than 40°C , gradually increase outdoor fan speed by 1 speed. (Upper limit 3rd speed)

3) Reset conditions

When either of the following conditions is satisfied

- a) The outdoor air temperature (TH2) is 24°C or higher.
- b) The compressor command speed is 0 rps.

(ii) Heating

1) Operating conditions

When the outdoor air temperature (TH2) is 3°C (model 63 : 1°C) or lower continues for 30 seconds while the compressor command speed is other than 0 rps.

2) Detail of operation

The outdoor fan is stepped up by 2 speed step at each 20 seconds. (Upper limit 8th (model71 : 7th) speed)

3) Reset conditions

When either of the following conditions is satisfied

- a) The outdoor air temperature (TH2) is 5°C (model 63 : 3°C) or higher.
- b) The compressor command speed is 0 rps.

(r) Outdoor fan control at overload conditions.

(i) Cooling

1) Operating conditions

When the outdoor air temperature (TH2) is 41°C(model 63:38°C) or higher continues for 30 seconds while the compressor ON

2) Detail of operation

The outdoor fan is stepped up by 3 speed step. (Upper limit 8th speed).

3) Reset conditions

When either of the following conditions is satisfied

- a) The outdoor air temperature (TH2) is 40°C(model 63:37°C) or lower.
- b) The compressor command speed 0 rps.

(ii) Heating

1) Operating conditions

When the outdoor heat exchanger temperature (TH1) is 13°C or higher continues for 30 seconds while the compressor ON

2) Detail of operation

The outdoor fan is lowered by 3 speed step. (Lower limit 2nd speed).

3) Reset conditions

When either of the following conditions is satisfied

- a) The outdoor heat exchanger temperature (TH1) is 10°C or lower.
- b) The compressor command speed 0 rps.

(s) Refrigeration cycle system protection**(i) Starting conditions**

- 1) When A minutes have elapsed after the compressor ON or the completion of the defrost operation
- 2) Other than the defrost operation
- 3) When, after satisfying the conditions of 1) and 2) above, the compressor speed, indoor air temperature (Th1) and indoor heat exchanger temperature (Th2) have satisfied the conditions in the following table for B minutes:

Operation mode		A	Compressor speed (N)	Room temperature (Th1)	Room temperature (Th1)/ Indoor heat exchanger temperature (Th2)	B	C
Cooling	Model 63	3	$40 \leq N$ (TH2 $\geq 0^\circ\text{C}$)	$10 \leq \text{Th1} \leq 40$	Th1-4<Th2	3	1
			$40 \leq N$ (TH2 < 0°C)				4
	Model 71, 80	3	$40 \leq N$				1
Heating ⁽¹⁾	Model 63	8	$40 \leq N$ (TH2 $\geq 0^\circ\text{C}$) $60 \leq N$ (TH2 < 0°C)	$0 \leq \text{Th1} \leq 40$	Th2<Th1+6	5	2
	Model 71, 80	5	$40 \leq N$				

Note (1) Except that the fan speed is Hi in heating operation and silent mode control.

(ii) Contents of control

- 1) When the conditions of (i) above are satisfied, the compressor stops.
- 2) Error stop occurs when the compressor has stopped C times within 60 minutes.

(iii) Reset condition

When the compressor has been turned OFF

(t) Service valve (gas side) closing operation**(i) Starting conditions**

- 1) Operation mode : Heating
- 2) Compressor conditions : OFF → ON

(ii) Contents control

If the output current of inverter exceeds the specifications, it makes the compressor stopping.

(iii) Anomalous stop control

If the inverter output current value exceeds the setting value within 80 seconds, the compressor stops.

10. MAINTENANCE DATA

(1) Cautions

- (a) If you are disassembling and checking an air-conditioner, be sure to turn off the power before beginning. When working on indoor units, let the unit sit for about 1 minute after turning off the power before you begin work. When working on an outdoor unit, there may be an electrical charge applied to the main circuit (electrolytic condenser), so begin work only after discharging this electrical charge (to DC10V or lower).
- (b) When taking out printed circuit boards, be sure to do so without exerting force on the circuit boards or package components.
- (c) When disconnecting and connecting connectors, take hold of the connector housing and do not pull on the lead wires.

(2) Items to check before troubleshooting

- (a) Have you thoroughly investigated the details of the trouble which the customer is complaining about?
- (b) Is the air-conditioner running? Is it displaying any self-diagnosis information?
- (c) Is a power source with the correct voltage connected?
- (d) Are the control lines connecting the indoor and outdoor units wired correctly and connected securely?
- (e) Is the outdoor unit's service valve open?

(3) Troubleshooting procedure (If the air-conditioner does not run at all)

If the air-conditioner does not run at all, diagnose the trouble using the following troubleshooting procedure. If the air-conditioner is running but breaks down, proceed to troubleshooting step (4).

Important When all the following conditions are satisfied, we say that the air-conditioner will not run at all.

- (a) The RUN light does not light up.
- (b) The flaps do not open.
- (c) The indoor unit fan motors do not run.
- (d) The self-diagnosis display does not function.

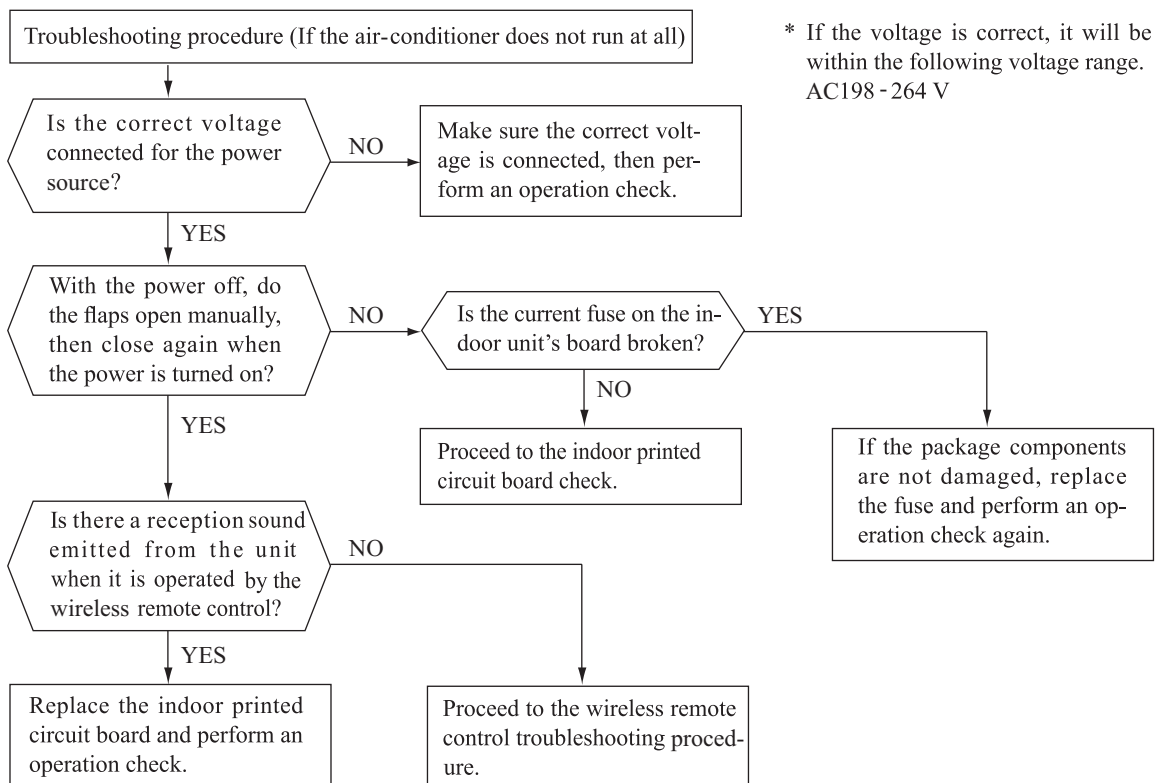

(4) Troubleshooting procedure (If the air-conditioner runs)

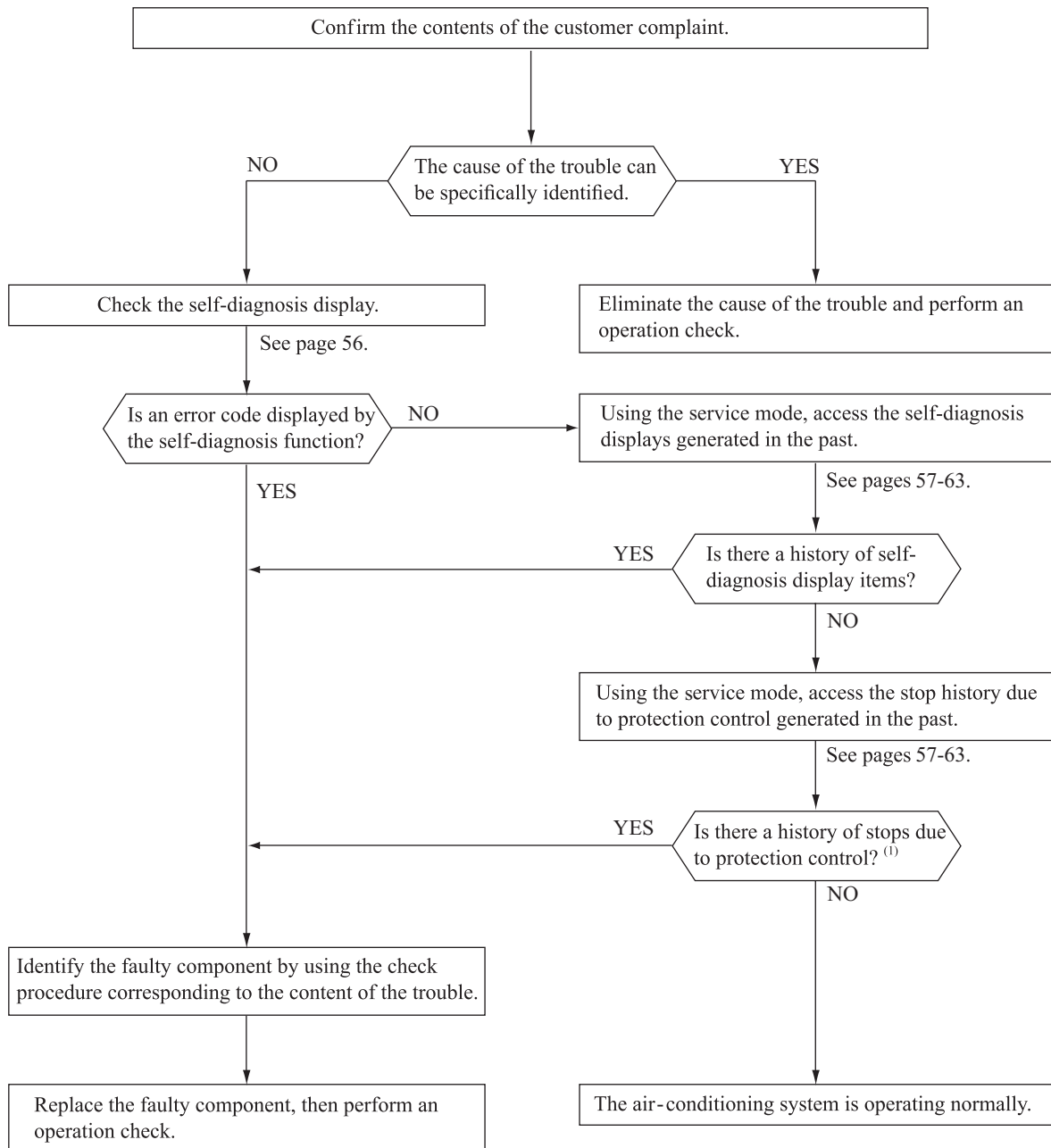

Note (1) Even in cases where only intermittent stop data are generated, the air-conditioning system is normal. However, if the same protective operation recurs repeatedly (3 or more times), it will lead to customer complaints. Judge the conditions in comparison with the contents of the complaints.

(5) Self-diagnosis table

When this air-conditioner performs an emergency stop, the reason why the emergency stop occurred is displayed by the flashing of display lights. If the air-conditioner is operated using the remote control 3 minutes or more after the emergency stop, the trouble display stops and the air-conditioner resumes operation. ⁽¹⁾

Indoor unit display panel		Wired ⁽²⁾ remote control display	Description of trouble	Cause	Display (flashing) condition
RUN light	TIMER light				
1-time flash	ON	—	Heat exchanger temperature sensor 1 error	<ul style="list-style-type: none"> Broken heat exchanger temperature sensor 1 wire, poor connector connection Indoor unit PCB is faulty 	When a heat exchanger temperature sensor 1 wire disconnection is detected while operation is stopped. (If a temperature of -28°C or lower is detected for 15 seconds, it is judged that the wire is disconnected.) (Not displayed during operation.)
2-time flash	ON	—	Room temperature sensor error	<ul style="list-style-type: none"> Broken room temperature sensor wire, poor connector connection Indoor unit PCB is faulty 	When a room temperature sensor wire disconnection is detected while operation is stopped. (If a temperature of -45°C or lower is detected for 15 seconds, it is judged that the wire is disconnected.) (Not displayed during operation.)
3-time flash	ON	—	Heat exchanger temperature sensor 2 error	<ul style="list-style-type: none"> Broken heat exchanger temperature sensor 2 wire, poor connector connection Indoor unit PCB is faulty 	When a heat exchanger temperature sensor 2 wire disconnection is detected while operation is stopped. (If a temperature of -28°C or lower is detected for 15 seconds, it is judged that the wire is disconnected.) (Not displayed during operation.)
6-time flash	ON	E 16	Indoor fan motor error	<ul style="list-style-type: none"> Defective fan motor, poor connector connection 	When conditions for turning the indoor fan motor on exist during air-conditioner operation, an indoor fan motor speed of 300min^{-1} or lower is measured for 30 seconds or longer. (The air-conditioner stops.)
Keeps flashing	1-time flash	E 38	Outdoor air temperature sensor error	<ul style="list-style-type: none"> Broken outdoor air temperature sensor wire, poor connector connection Outdoor unit PCB is faulty 	-55°C or lower is detected for 5 seconds continuously 3 times within 40 minutes after initial detection of this anomalous temperature. Or -55°C or higher is detected for within 20 seconds after power ON. (The compressor is stopped.)
Keeps flashing	2-time flash	E 37	Outdoor heat exchanger temperature sensor error	<ul style="list-style-type: none"> Broken heat exchanger temperature sensor wire, poor connector connection Outdoor unit PCB is faulty 	-55°C or lower is detected for 5 seconds continuously 3 times within 40 minutes after initial detection of this anomalous temperature. Or -55°C or higher is detected for within 20 seconds after power ON. (The compressor is stopped.)
Keeps flashing	4-time flash	E 39	Discharge pipe temperature sensor error	<ul style="list-style-type: none"> Broken discharge pipe temperature sensor wire, poor connector connection Outdoor unit PCB is faulty 	-25°C or lower is detected for 5 seconds continuously 3 times within 40 minutes after initial detection of this anomalous temperature. (The compressor is stopped.)
ON	1-time flash	E 42	Current cut	<ul style="list-style-type: none"> Compressor locking, open phase on compressor output, short-circuit on power transistor, service valve is closed 	The compressor output current exceeds the set value during compressor start. (The air-conditioner stops.)
ON	2-time flash	E 59	Trouble of outdoor unit	<ul style="list-style-type: none"> Broken compressor wire Compressor blockage 	When there is an emergency stop caused by trouble in the outdoor unit, or the input current value is found to be lower than the set value. (The air-conditioner stops.)
ON	3-time flash	E 58	Current safe stop	<ul style="list-style-type: none"> Overload operation Overcharge Compressor locking 	When the compressor command speed is lower than the set value and the current safe has operated. (the compressor stops)
ON	4-time flash	E 51	Power transistor error	<ul style="list-style-type: none"> Broken power transistor 	When the power transistor is judged breakdown while compressor starts. (The compressor is stopped.)
ON	5-time flash	E 36	Over heat of compressor	<ul style="list-style-type: none"> Gas shortage, defective discharge pipe temperature sensor, service valve is closed 	When the value of the discharge pipe temperature sensor exceeds the set value. (The air-conditioner stops.)
ON	6-time flash	E 5	Error of signal transmission	<ul style="list-style-type: none"> Defective power source, Broken signal wire, defective indoor/outdoor unit PCB 	When there is no signal between the indoor unit PCB and outdoor unit PCB for 10 seconds or longer (when the power is turned on), or when there is no signal for 7 minute 35 seconds or longer (during operation) (the compressor is stopped).
ON	7-time flash	E 48	Outdoor fan motor error	<ul style="list-style-type: none"> Defective fan motor, poor connector connection 	When the outdoor fan motor speed continues for 30 seconds or longer at 75min^{-1} or lower. (3 times) (The air-conditioner stops.)
ON	Keeps flashing	E 35	Cooling high pressure protecton	<ul style="list-style-type: none"> Overload operation, overcharge Broken outdoor heat exchanger temperature sensor wire Service valve is closed 	When the value of the outdoor heat exchanger temperature sensor exceeds the set value.
2-time flash	2-time flash	E 60	Rotor lock	<ul style="list-style-type: none"> Defective compressor Open phase on compressor Defective outdoor unit PCB 	If the compressor motor's magnetic pole positions cannot be correctly detected when the compressor starts. (The air-conditioner stops.)
4-time flash	ON	—	Trouble of wireless LAN interface	<ul style="list-style-type: none"> Defective wireless LAN interface boards, poor connector connection 	When normal data cannot be received from wireless LAN interface for two minutes continuously
5-time flash	ON	E 47	Active filter voltage error	<ul style="list-style-type: none"> Defective active filter 	When the wrong voltage connected for the power source. When the outdoor unit PCB is faulty
7-time flash	ON	E 57	Refrigeration cycle system protective control	<ul style="list-style-type: none"> Service valve is closed. Refrigerant is insufficient 	When refrigeration cycle system protective control operates.
7-time flash	1-time flash	E 40	Service valve (gas side) closed operation	<ul style="list-style-type: none"> Service valve (gas side) closed Defective outdoor unit PCB 	If the output current of inverter exceeds the specifications, it makes the compressor stopping. (In heating mode). After 3-minute delay, the compressor restarts, but if this anomaly occurs 2 times within 20 minutes after the initial detection.
—	—	E 1	Error of wired remote control wiring	<ul style="list-style-type: none"> Broken wired remote control wire, defective indoor unit PCB 	The wired remote control wire Y is open. The wired remote control wires X and Y are reversely connected. Noise is penetrating the wired remote control lines. The wired remote control or indoor unit PCB is faulty. (The communications circuit is faulty.)

Notes (1)The air-conditioner cannot be restarted using the remote control for 3 minutes after operation stops.

(2)The wired remote control is option parts.

(6) Service mode (Trouble mode access function)

This air-conditioner is capable of recording error displays and protective stops (service data) which have occurred in the past. If self-diagnosis displays cannot be confirmed, it is possible to get a grasp of the conditions at the time trouble occurred by checking these service data.

(a) Explanation of terms

Term	Explanation
Service mode	The service mode is the mode where service data are displayed by flashing of the display lights when the operations in item (b) below are performed with the indoor control.
Service data	These are the contents of error displays and protective stops which occurred in the past in the air-conditioner system. Error display contents and protective stop data from past anomalous operations of the air-conditioner system are saved in the indoor unit control's non-volatile memory (memory which is not erased when the power goes off). There are two types of data, self-diagnosis data and stop data, described below.
Self-diagnosis data	These are the data which display the reason why a stop occurred when an error display(self-diagnosis display) occurred in an indoor unit. Data are recorded for up to 5 previous occurrences. Data which are older than the 5th previous occurrence are erased. In addition, data on the temperature of each sensor (room temperature, indoor heat exchanger, outdoor heat exchanger, outdoor air temperature, discharge pipe), remote control information (operation switching, fan speed switching) are recorded when trouble occurs, so more detailed information can be checked.
Stop data	These are the data which display the reason by a stop occurred when the air-conditioning system performed protective stops, etc. in the past. Even if stop data alone are generated, the system restarts automatically. (After executing the stop mode while the display is normal, the system restarts automatically.) Data for up to 10 previous occasions are stored. Data older than the 10th previous occasion are erased. (Important) In cases where transient stop data only are generated, the air-conditioner system may still be normal. However, if the same protective stop occurs frequently (3 or more times), it could lead to customer complaints.

(b) Service mode display procedure

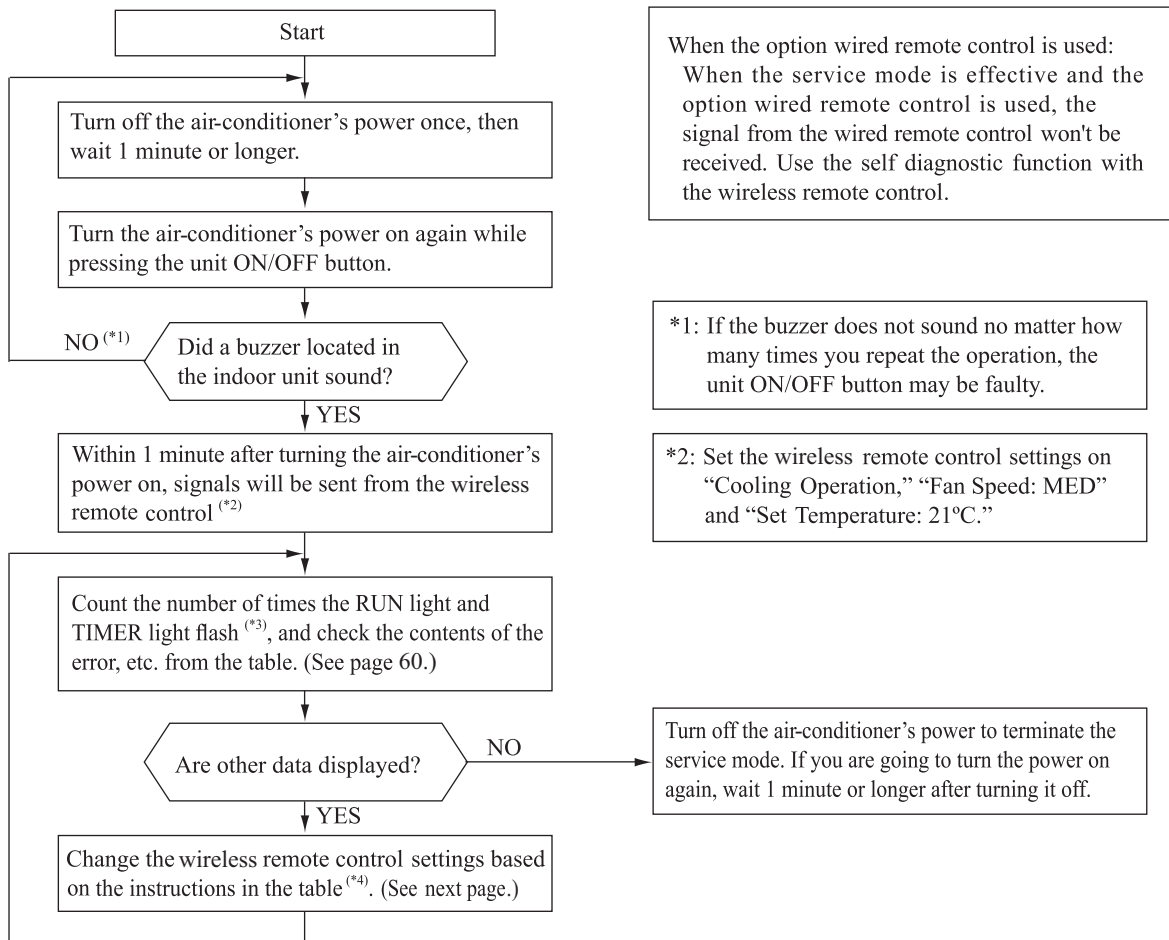

*3: To count the number of flashes in the service mode, count the number of flashes after the light lights up for 1.5 second initially (start signal). (The time that the light lights up for 1.5 second (start signal) is not counted in the number of flashes.)

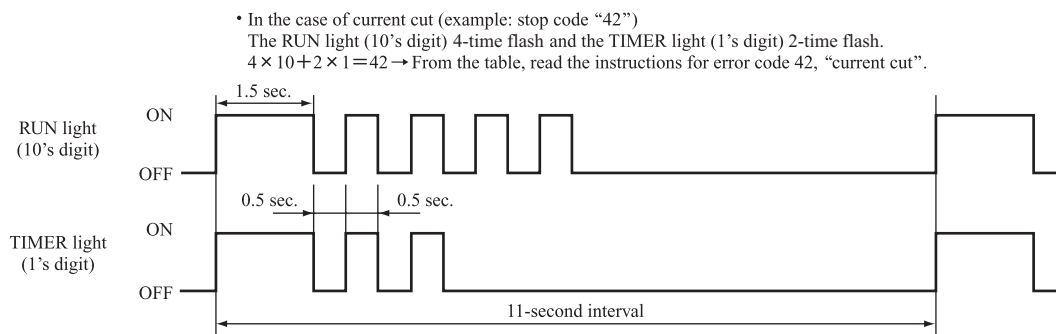

*4: When in the service mode, when the wireless remote control settings (operation mode, fan speed mode, temperature setting) are set as shown in the following table and sent to the air-conditioner unit, the unit switches to display of service data.

(i) Self-diagnosis data

What are Self-diagnosis Data?

These are control data (reasons for stops, temperature at each sensor, wireless remote control information) from the time when there were error displays (abnormal stops) in the indoor unit in the past. Data from up to 5 previous occasions are stored in memory. Data older than the 5th previous occasion are erased. The temperature setting indicates how many occasions previous to the present setting the error display data are and the operation mode and fan speed mode data show the type of data.

Wireless remote control setting		Contents of output data
Operation mode	Fan speed mode	
Cooling	MED	Displays the reason for stopping display in the past (error code).
	HI	Displays the room temperature sensor temperature at the time the error code was displayed in the past.
	AUTO	Displays the indoor heat exchanger temperature sensor temperature at the time the error code was displayed in the past.
Heating	LO	Displays the wireless remote control information at the time the error code was displayed in the past.
	MED	Displays the outdoor air temperature sensor temperature at the time the error code was displayed in the past.
	HI	Displays the outdoor heat exchanger temperature sensor temperature at the time the error code was displayed in the past.
	AUTO	Displays the discharge pipe temperature sensor temperature at the time the error code was displayed in the past.

Wireless remote control setting	Indicates the number of occasions previous to the present the error display data are from.
Temperature setting	
21°C	1 time previous (previous time)
22°C	2 times previous
23°C	3 times previous
24°C	4 times previous
25°C	5 times previous

Only for indoor heat exchanger temperature sensor 2

Wireless remote control setting	Indicates the number of occasions previous to the present the error display data are from.
Temperature setting	
26°C	1 time previous (previous time)
27°C	2 times previous
28°C	3 times previous
29°C	4 times previous
30°C	5 times previous

(Example)

Wireless remote control setting			Displayed data
Operation mode	Fan speed mode	Temperature setting	
Cooling	MED	21°C	Displays the reason for the stop (error code) the previous time an error was displayed.
		22°C	Displays the reason for the stop (error code) 2 times previous when an error was displayed.
		23°C	Displays the reason for the stop (error code) 3 times previous when an error was displayed.
		24°C	Displays the reason for the stop (error code) 4 times previous when an error was displayed.
		25°C	Displays the reason for the stop (error code) 5 times previous when an error was displayed.

(ii) Stop data

Wireless remote control setting			Displayed data
Operation mode	Fan speed mode	Temperature setting	
Cooling	LO	21°C	Displays the reason for the stop (stop code) the previous time when the air-conditioner was stopped by protective stop control.
		22°C	Displays the reason for the stop (stop code) 2 times previous when the air-conditioner was stopped by protective stop control.
		23°C	Displays the reason for the stop (stop code) 3 times previous when the air-conditioner was stopped by protective stop control.
		24°C	Displays the reason for the stop (stop code) 4 times previous when the air-conditioner was stopped by protective stop control.
		25°C	Displays the reason for the stop (stop code) 5 times previous when the air-conditioner was stopped by protective stop control.
		26°C	Displays the reason for the stop (stop code) 6 times previous when the air-conditioner was stopped by protective stop control.
		27°C	Displays the reason for the stop (stop code) 7 times previous when the air-conditioner was stopped by protective stop control.
		28°C	Displays the reason for the stop (stop code) 8 times previous when the air-conditioner was stopped by protective stop control.
		29°C	Displays the reason for the stop (stop code) 9 times previous when the air-conditioner was stopped by protective stop control.
		30°C	Displays the reason for the stop (stop code) 10 times previous when the air-conditioner was stopped by protective stop control.

(c) Error code, stop code table (Assignment of error codes and stop codes is done in common for all models.)

Number of flashes when in service mode		Stop code or Error code	Error content	Cause	Occurrence conditions	Error display	Auto recovery
RUN light (10's digit)	TIMER light (1's digit)						
OFF	OFF	0	Normal	—	—	—	—
	1-time flash	01	Error of wired remote control wiring (When wired remote control was connected) (When wireless LAN interface was connected, refer to page 56.)	Broken wired remote control wire defective indoor unit PCB.	The wired remote control wire Y is open. The wired remote control wires X and Y are reversely connected. Noise is penetrating the wired remote control lines. The wired remote control or indoor unit PCB is faulty.	—	○
	5-time flash	05	Can not receive signals for 35 seconds (if communications have recovered)	Power source is faulty Power source cables and signal lines are improperly wired. Indoor or outdoor unit PCB are faulty	When 35 seconds passes without communications signals from either the outdoor unit or the indoor unit being detected correctly.	○	—
3-time flash	5-time flash	35	Cooling high pressure control	Cooling overload operation. Outdoor unit fan speed drops. Outdoor heat exchanger temperature sensor is short-circuit.	When the outdoor heat exchanger temperature sensor's value exceeds the set value.	○ (5 times)	○
	6-time flash	36	Compressor overheat 110°C	Refrigerant is insufficient. Discharge pipe temperature sensor is faulty. Service valve is closed.	When the discharge pipe temperature sensor's value exceeds the set value.	○ (2 times)	○
	7-time flash	37	Outdoor heat exchanger temperature sensor is abnormal	Outdoor heat exchanger temperature sensor wire is disconnected. Connector connections are poor. Outdoor unit PCB is faulty	-55°C or lower is detected for 5 seconds continuously 3 times within 40 minutes after initial detection of this anomalous temperature. Or -55°C higher is detected for 5 seconds continuously within 20 seconds after power ON.	○ (3 times)	○
	8-time flash	38	Outdoor air temperature sensor is abnormal	Outdoor air temperature sensor wire is disconnected. Connector connections are poor. Outdoor unit PCB is faulty	-55°C or lower is detected for 5 seconds continuously 3 times within 40 minutes after initial detection of this anomalous temperature. Or -55°C higher is detected for 5 seconds continuously within 20 seconds after power ON.	○ (3 times)	○
	9-time flash	39	Discharge pipe temperature sensor is abnormal (anomalous stop)	Discharge pipe temperature sensor wire is disconnected. Connector connections are poor. Outdoor unit PCB is faulty	-25°C or lower is detected for 5 seconds continuously 3 times within 40 minutes after initial detection of this anomalous temperature.	○ (3 times)	○
4-time flash	OFF	40	Service valve (gas side) closed operation	Service valve (gas side) closed Outdoor unit PCB is faulty.	If the inverter output current value exceeds the setting value within 80 seconds after the compressor ON in the heating mode, the compressor stops.	○ (2 times)	○
	2-time flash	42	Current cut	Compressor lock. Compressor wiring short circuit. Compressor output is open phase. Outdoor unit PCB is faulty Service valve is closed. Electronic expansion valve is faulty. Compressor is faulty.	Compressor start fails 42 times in succession and the reason for the final failure is current cut.	○ (2 times)	○
	7-time flash	47	Active filter voltage error	Defective active filter	When the wrong voltage connected for the power source. When the outdoor unit PCB is faulty.	○	—
	8-time flash	48	Outdoor fan motor is abnormal	Outdoor fan motor is faulty. Connector connections are poor. Outdoor unit PCB is faulty	When a fan speed of 75 min ⁻¹ or lower continues for 30 seconds or longer.	○ (3 times)	○
5-time flash	1-time flash	51	Short-circuit in the power transistor (high side) Current cut circuit breakdown	Outdoor unit PCB is faulty Power transistor is damaged.	When it is judged that the power transistor was damaged at the time the compressor started.	○	—
	7-time flash	57	Refrigeration cycle system protective control	Service valve is closed. Refrigerant is insufficient.	When refrigeration cycle system protective control operates.	○ (3 times)	○
	8-time flash	58	Current safe	Refrigerant is overcharge. Compressor lock. Overload operation.	When there is a current safe stop during operation.	—	○
	9-time flash	59	Compressor wiring is unconnection Voltage drop Low speed protective control	Compressor wiring is disconnected. Power transistor is damaged. Power source construction is defective. Outdoor unit PCB is faulty Compressor is faulty.	When the current is 1A or less at the time the compressor started. When the power source voltage drops during operation. When the compressor command speed is lower than 32 rps for 60 minutes.	○	○
6-time flash	OFF	60	Rotor lock	Compressor is faulty. Compressor output is open phase. Electronic expansion valve is faulty. Overload operation. Outdoor unit PCB is faulty	After the compressor starts, when the compressor stops due to rotor lock.	○ (2 times)	○
	1-time flash	61	Connection lines between the indoor and outdoor units are faulty	Connection lines are faulty. Indoor or outdoor unit PCB are faulty	When 10 seconds passes after the power is turned on without communications signals from the indoor or outdoor unit being detected correctly.	○	—
	2-time flash	62	Serial transmission error	Indoor or outdoor unit PCB are faulty Noise is causing faulty operation.	When 7 minute 35 seconds passes without communications signals from either the outdoor unit or the indoor unit being detected correctly.	○	—
8-time flash	OFF	80	Indoor fan motor is abnormal	Indoor fan motor is faulty. Connector connections are poor. Indoor unit PCB is faulty	When the indoor fan motor is detected to be running at 300min ⁻¹ or lower speed with the fan motor in the ON condition while the air-conditioner is running.	○	—
	2-time flash	82	Indoor heat exchanger temperature sensor is abnormal (anomalous stop)	Indoor heat exchanger temperature sensor wire is disconnected. Connector connections are poor.	When a temperature of -28°C or lower is sensed continuously for 40 minutes during heating operation. (the compressor stops).	○	—
	4-time flash	84	Anti-condensation control	High humidity condition.	Anti-condensation prevention control is operating.	—	○
	5-time flash	85	Anti-frost control	Indoor fan speed drops. Indoor heat exchanger temperature sensor is broken wire.	When the anti-frost control operates and the compressor stops during cooling operation.	—	○
	6-time flash	86	Heating high pressure control	Heating overload operation. Indoor fan speed drops. Indoor heat exchanger temperature sensor is short-circuit.	When high pressure control operates during heating operation and the compressor stops.	—	○

Notes (1) The number of flashes when in the service mode do not include the 1.5 second period when the lights light up at first (start signal).
(See the example shown below.)

- In the case of current cut (example: stop code “42”)
The RUN light (10’s digit) 4-time flash and the TIMER light (1’s digit) 2-time flash.
 $4 \times 10 + 2 \times 1 = 42 \rightarrow$ From the table, read the instructions for error code 42, “current cut”.

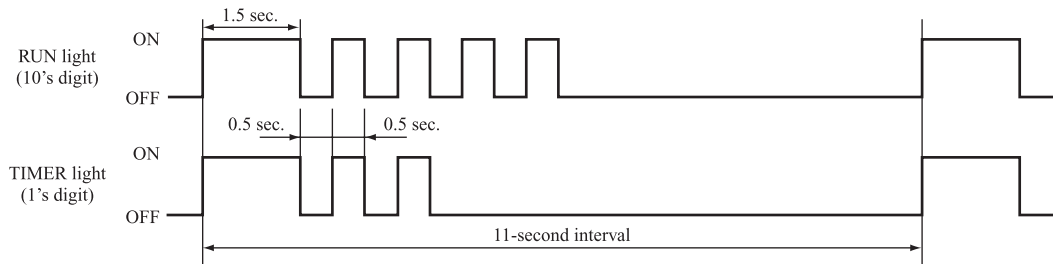

- (2) Error display:
 — Is not displayed. (automatic recovery only)
 Displayed.
 If there is a () displayed, the error display shows the number of times that an auto recovery occurred for the same reason has reached the number of times in ().
 If no () is displayed, the error display shows that the trouble has occurred once.
- (3) Auto Recovery:
 — Does not occur
 Auto recovery occurs.

(d) Operation mode, Fan speed mode information tables

(i) Operation mode

Display pattern when in service mode	Operation mode when there is an abnormal stop
RUN light (10's digit)	
—	AUTO
1-time flash	DRY
2-time flash	COOL
3-time flash	FAN
4-time flash	HEAT

(ii) Fan speed mode

Display pattern when in service mode	Fan speed mode when there is an abnormal stop
TIMER light (1's digit)	
—	AUTO
2-time flash	HI
3-time flash	MED
4-time flash	LO
5-time flash	ULO
6-time flash	HI POWER
7-time flash	ECONO

* If no data are recorded (error code is normal), the information display in the operation mode and fan speed mode becomes as follows.

Mode	Display when error code is normal
Operation mode	AUTO
Fan speed mode	AUTO

(Example): Operation mode: COOL, Fan speed mode: HI

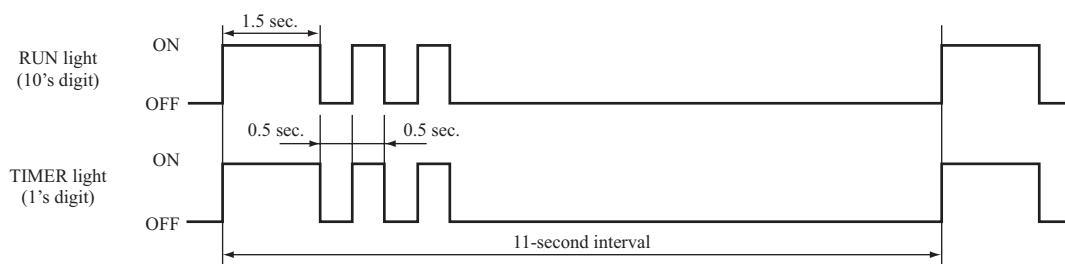

(e) Temperature information

(i) Room temperature sensor, indoor heat exchanger temperature sensor, outdoor air temperature sensor, outdoor heat exchanger temperature sensor

Unit: °C

Buzzer sound	TIMER light (1's digit)	RUN light (10's digit)										
		0	1	2	3	4	5	6	7	8	9	
Yes (sounds for 0.1 second)	6	-60	-61	-62	-63	-64						
	5	-50	-51	-52	-53	-54	-55	-56	-57	-58	-59	
	4	-40	-41	-42	-43	-44	-45	-46	-47	-48	-49	
	3	-30	-31	-32	-33	-34	-35	-36	-37	-38	-39	
	2	-20	-21	-22	-23	-24	-25	-26	-27	-28	-29	
	1	-10	-11	-12	-13	-14	-15	-16	-17	-18	-19	
	0		-1	-2	-3	-4	-5	-6	-7	-8	-9	
No (does not sound)	0	0	1	2	3	4	5	6	7	8	9	
	1	10	11	12	13	14	15	16	17	18	19	
	2	20	21	22	23	24	25	26	27	28	29	
	3	30	31	32	33	34	35	36	37	38	39	
	4	40	41	42	43	44	45	46	47	48	49	
	5	50	51	52	53	54	55	56	57	58	59	
	6	60	61	62	63	64	65	66	67	68	69	
	7	70	71	72	73	74	75	76	77	78	79	
	8	80	81	82	83	84	85	86	87	88	89	
	9	90	91	92	93	94	95	96	97	98	99	

* If no data are recorded (error code is normal), the display for each temperature information becomes as shown below.

Sensor name	Sensor value displayed when the error code is normal
Room temperature sensor	-64°C
Indoor heat exchanger temperature sensor	-64°C
Outdoor air temperature sensor	-64°C
Outdoor heat exchanger temperature sensor	-64°C

(Example) Outdoor heat exchanger temperature data: “-9°C”

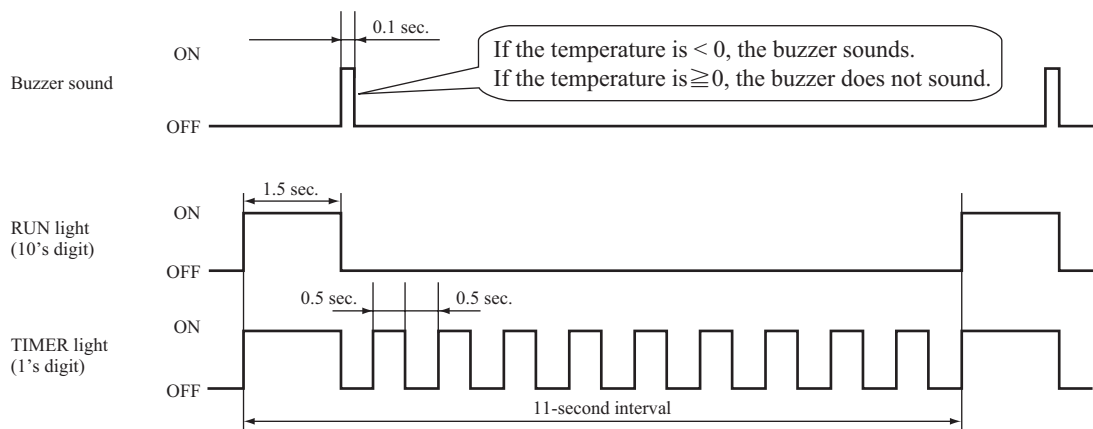

(ii) Discharge pipe temperature sensor

Unit: °C

Buzzer sound	TIMER light (1's digit)	RUN light (10's digit)									
			0	1	2	3	4	5	6	7	8
Yes (sounds for 0.1 second)	3	-60	-62	-64							
	2	-40	-42	-44	-46	-48	-50	-52	-54	-56	-58
	1	-20	-22	-24	-26	-28	-30	-32	-34	-36	-38
	0	/	-2	-4	-6	-8	-10	-12	-14	-16	-18
No (does not sound)	0	0	2	4	6	8	10	12	14	16	18
	1	20	22	24	26	28	30	32	34	36	38
	2	40	42	44	46	48	50	52	54	56	58
	3	60	62	64	66	68	70	72	74	76	78
	4	80	82	84	86	88	90	92	94	96	98
	5	100	102	104	106	108	110	112	114	116	118
	6	120	122	124	126	128	130	132	134	136	138
	7	140	142	144	146	148	150				

* If no data are recorded (error code is normal), the display for each temperature information becomes as shown below.

Sensor name	Sensor value displayed when the error code is normal
Discharge pipe temperature sensor	-64°C

(Example) Discharge pipe temperature data: "122°C"

* In the case of discharge pipe data, multiply the reading value by 2. (Below, $61 \times 2 = "122°C"$)

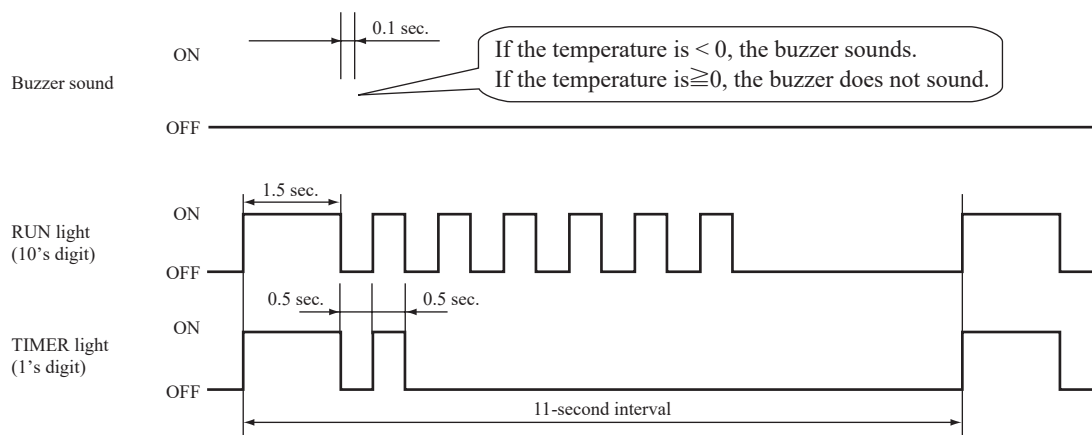

Service data record form

Customer		Model					
Date of investigation							
Machine name							
Content of complaint							
Wireless remote control settings			Content of displayed data	Display results			Display content
Temperature setting	Operation mode	Fan speed mode		Buzzer (Yes/No.)	RUN light (Times)	TIMER light (Times)	
21	Cooling	MED	Error code on previous occasion	/			
		HI	Room temperature sensor on previous occasion				
		AUTO	Indoor heat exchanger temperature sensor 1 on previous occasion				
	Heating	LO	Wireless remote control information on previous occasion	/			
		MED	Outdoor air temperature sensor on previous occasion				
		HI	Outdoor heat exchanger temperature sensor on previous occasion				
	AUTO	Discharge pipe temperature sensor on previous occasion					
26	Cooling	AUTO	Indoor heat exchanger temperature sensor 2 on previous occasion				
22	Cooling	MED	Error code on second previous occasion	/			
		HI	Room temperature sensor on second previous occasion				
		AUTO	Indoor heat exchanger temperature sensor 1 on second previous occasion				
	Heating	LO	Wireless remote control information on second previous occasion	/			
		MED	Outdoor air temperature sensor on second previous occasion				
		HI	Outdoor heat exchanger temperature sensor on second previous occasion				
	AUTO	Discharge pipe temperature sensor on second previous occasion					
27	Cooling	AUTO	Indoor heat exchanger temperature sensor 2 on second occasion				
23	Cooling	MED	Error code on third previous occasion	/			
		HI	Room temperature sensor on third previous occasion				
		AUTO	Indoor heat exchanger temperature sensor 1 on third previous occasion				
	Heating	LO	Wireless remote control information on third previous occasion	/			
		MED	Outdoor air temperature sensor on third previous occasion				
		HI	Outdoor heat exchanger temperature sensor on third previous occasion				
	AUTO	Discharge pipe temperature sensor on third previous occasion					
28	Cooling	AUTO	Indoor heat exchanger temperature sensor 2 on third occasion				
24	Cooling	MED	Error code on fourth previous occasion	/			
		HI	Room temperature sensor on fourth previous occasion				
		AUTO	Indoor heat exchanger temperature sensor 1 on fourth previous occasion				
	Heating	LO	Wireless remote control information on fourth previous occasion	/			
		MED	Outdoor air temperature sensor on fourth previous occasion				
		HI	Outdoor heat exchanger temperature sensor on fourth previous occasion				
	AUTO	Discharge pipe temperature sensor on fourth previous occasion					
29	Cooling	AUTO	Indoor heat exchanger temperature sensor 2 on fourth occasion				
25	Cooling	MED	Error code on fifth previous occasion	/			
		HI	Room temperature sensor on fifth previous occasion				
		AUTO	Indoor heat exchanger temperature sensor 1 on fifth previous occasion				
	Heating	LO	Wireless remote control information on fifth previous occasion	/			
		MED	Outdoor air temperature sensor on fifth previous occasion				
		HI	Outdoor heat exchanger temperature sensor on fifth previous occasion				
	AUTO	Discharge pipe temperature sensor on fifth previous occasion					
30	Cooling	AUTO	Indoor heat exchanger temperature sensor 2 on fifth occasion				
21	Cooling	LO	Stop code on previous occasion				
22			Stop code on second previous occasion				
23			Stop code on third previous occasion				
24			Stop code on fourth previous occasion				
25			Stop code on fifth previous occasion				
26			Stop code on sixth previous occasion				
27			Stop code on seventh previous occasion				
28			Stop code on eighth previous occasion				
29			Stop code on ninth previous occasion				
30			Stop code on tenth previous occasion				
Judgment							Examiner
Remarks							

Note (1) In the case of indoor heat exchanger temperature sensor 2, match from 26 to 30 the temperature setting of wireless remote control. (Refer to page 58.)

(7) Inspection procedures corresponding to detail of trouble

Sensor error

[Broken sensor wire, connector poor connection]

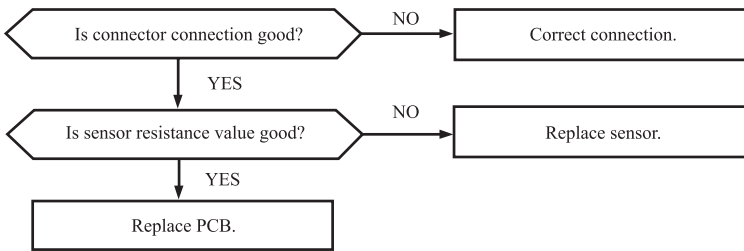

◆ Discharge pipe temperature sensor characteristics

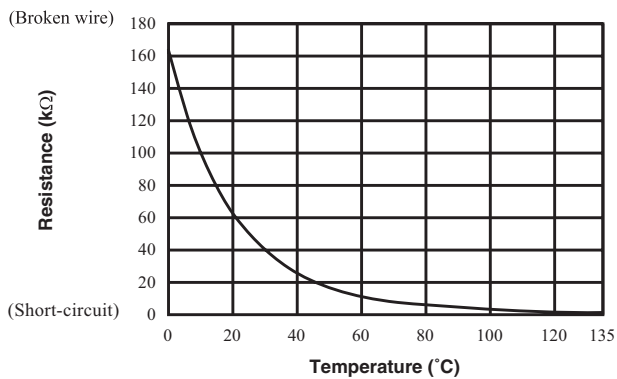

◆ Temperature sensor characteristics (Room temperature, indoor heat exchanger temperature, outdoor heat exchanger temperature, outdoor air temperature)

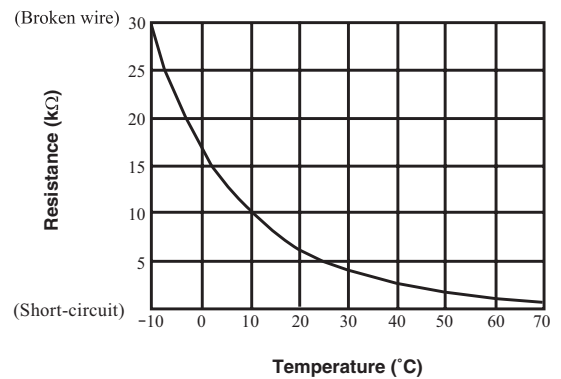

Indoor fan motor error

[Defective fan motor, connector poor connection, defective indoor unit PCB]

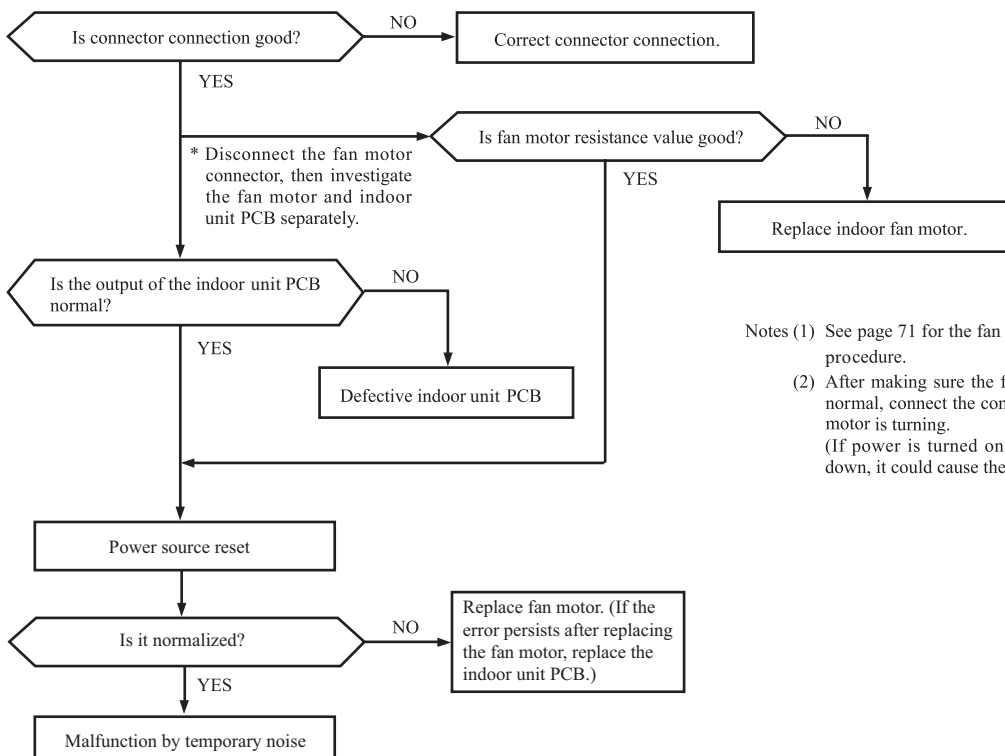

Notes (1) See page 71 for the fan motor and indoor unit PCB check procedure.
 (2) After making sure the fan motor and indoor unit PCB are normal, connect the connectors and confirm that the fan motor is turning.
 (If power is turned on while one or the other is broken down, it could cause the other to break down also.)

Current cut

[Compressor lock, Compressor wiring short-circuit, Compressor output is open phase, Outdoor unit PCB is faulty, Service valve is closed, EEV is faulty, Compressor faulty.]

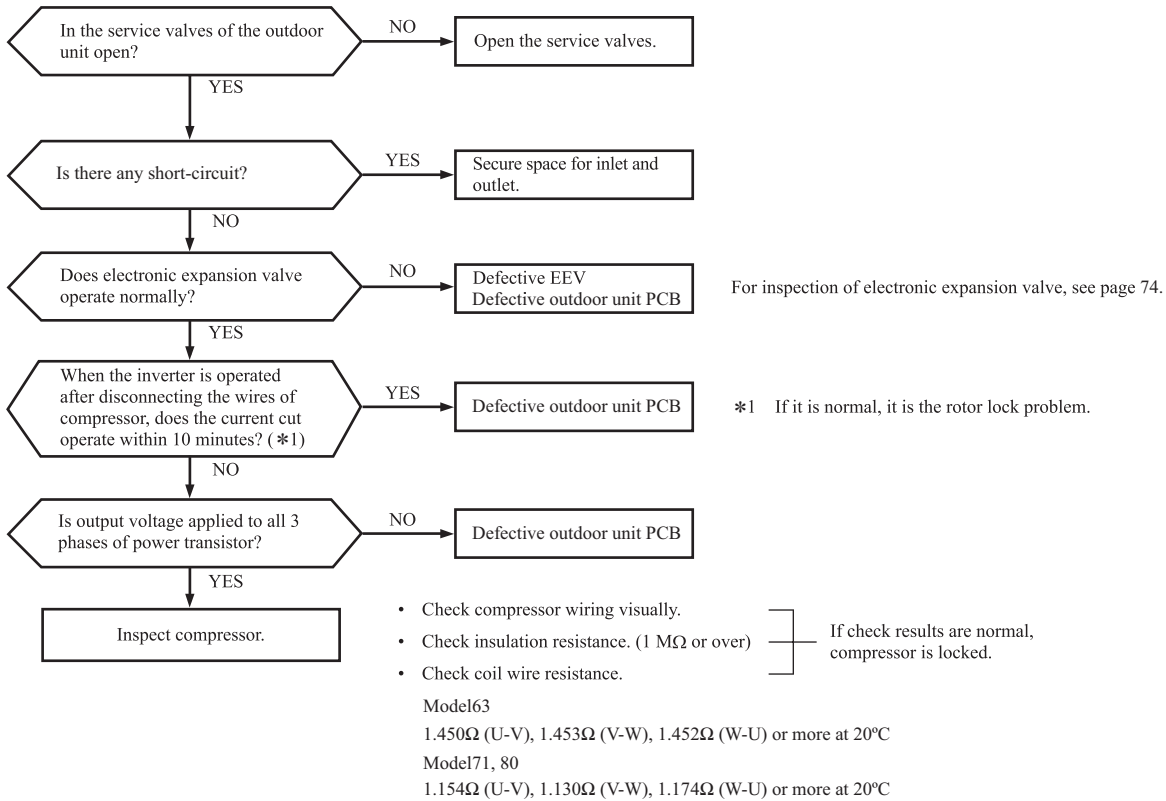

Current safe stop

[Overload operation, compressor lock, overcharge]

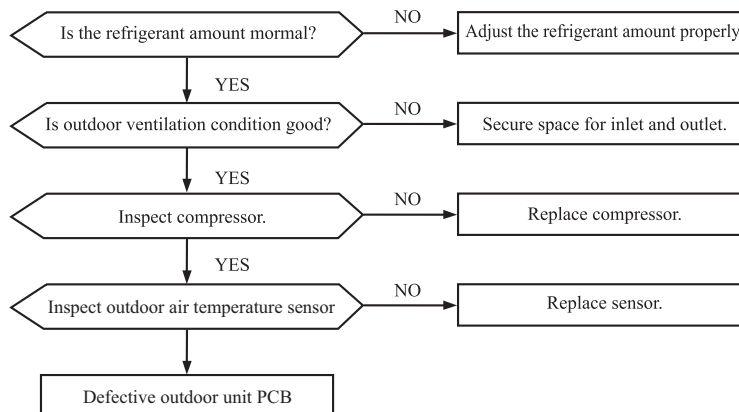

Overheat of compressor

[Gas shortage, defective discharge pipe temperature sensor]

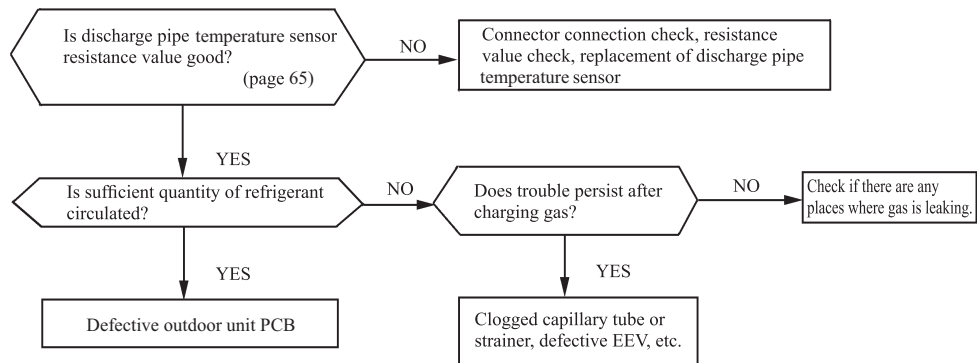

Error of signal transmission

[Wiring error including power cable, defective indoor/ outdoor unit PCB]

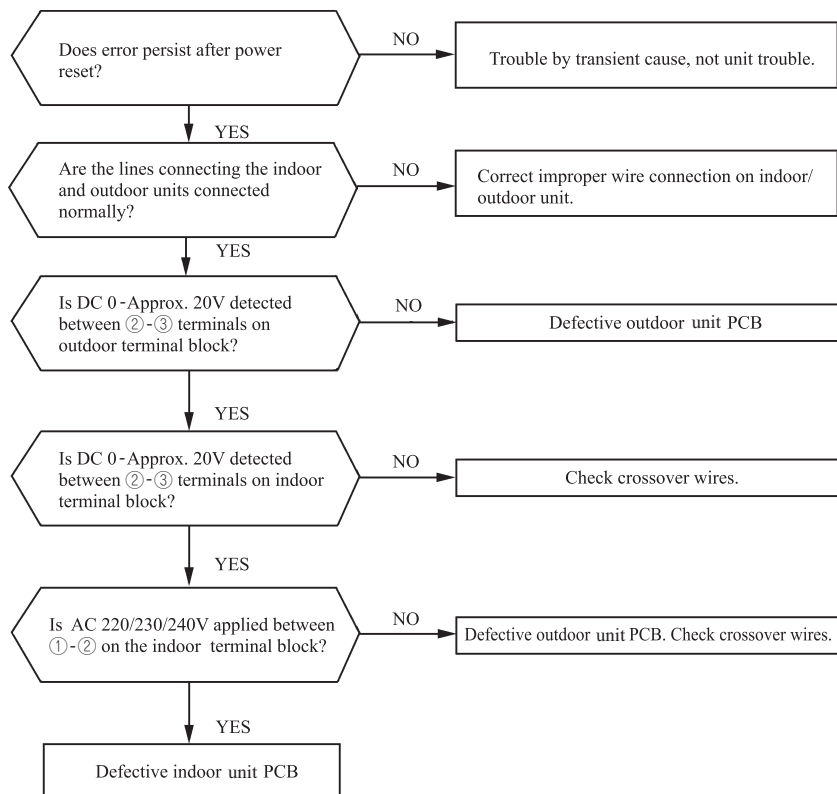

Trouble of outdoor unit

[Insufficient refrigerant amount, Faulty power transistor, Broken compressor wire]
 [Service valve close, Defective EEV, Defective outdoor unit PCB]

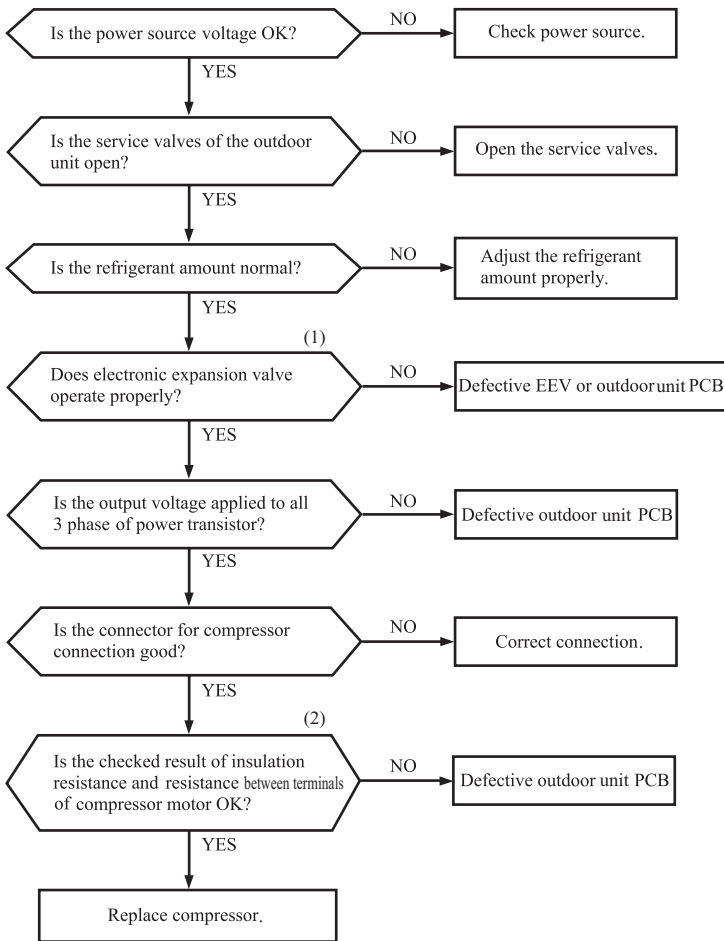

Proper power source voltages are as follows.
 (At the power source outlet)
 AC220V : AC 198-242V
 AC230V : AC 207-253V
 AC240V : AC 216-264V

- ◆ Judgment of refrigerant quantity
- (1) Phenomenon of insufficient refrigerant
 - (a) Loss of capacity
 - (b) Poor defrost operation
(Frost is not removed completely.)
 - (c) Longer time of hot keep
(5 minutes or more)
(Normal time: Approx. 1 – 1 minute and 30 seconds)

Notes (1) For inspection of electronic expansion valve, see page 74.
 (2) Check resistance between terminals, see page 66.

Outdoor fan motor error

[Defective fan motor, connector poor connection, defective outdoor unit PCB]

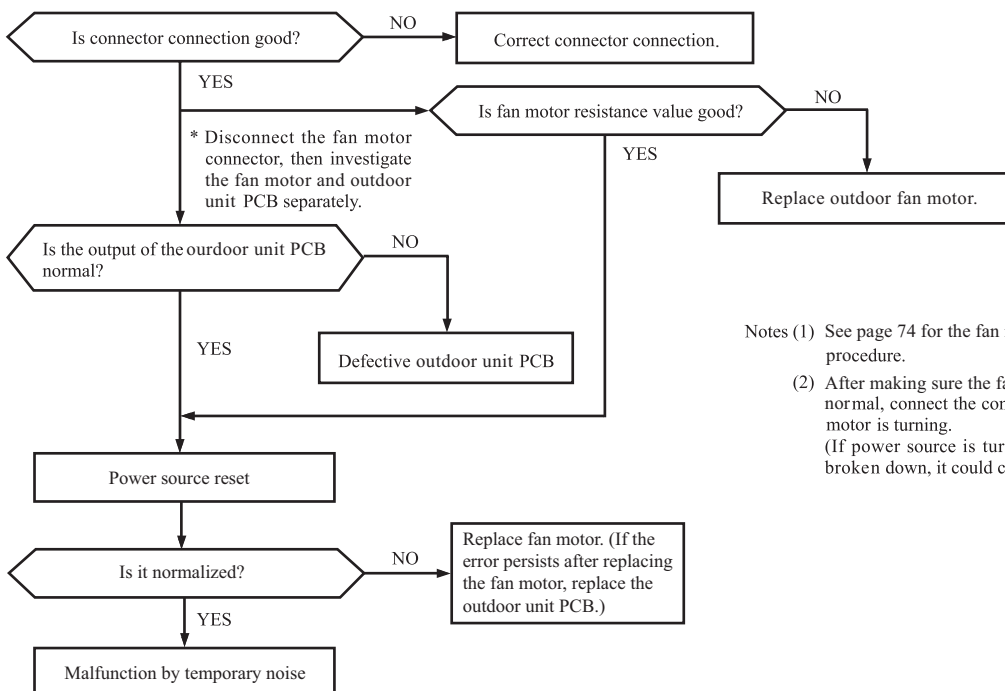

- Notes (1) See page 74 for the fan motor and outdoor unit PCB check procedure.
 (2) After making sure the fan motor and outdoor unit PCB are normal, connect the connectors and confirm that the fan motor is turning.
 (If power source is turned on while one or the other is broken down, it could cause the other to break down also.)

Rotor lock

[Defective compressor, defective outdoor unit PCB]

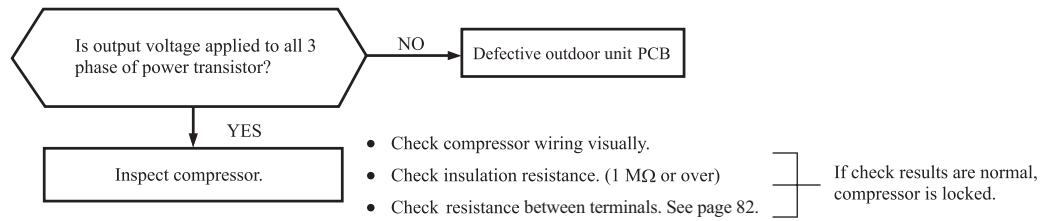

Service valve (gas side) closed operation

[Service valve (gas side) closed, Defective outdoor unit PCB]

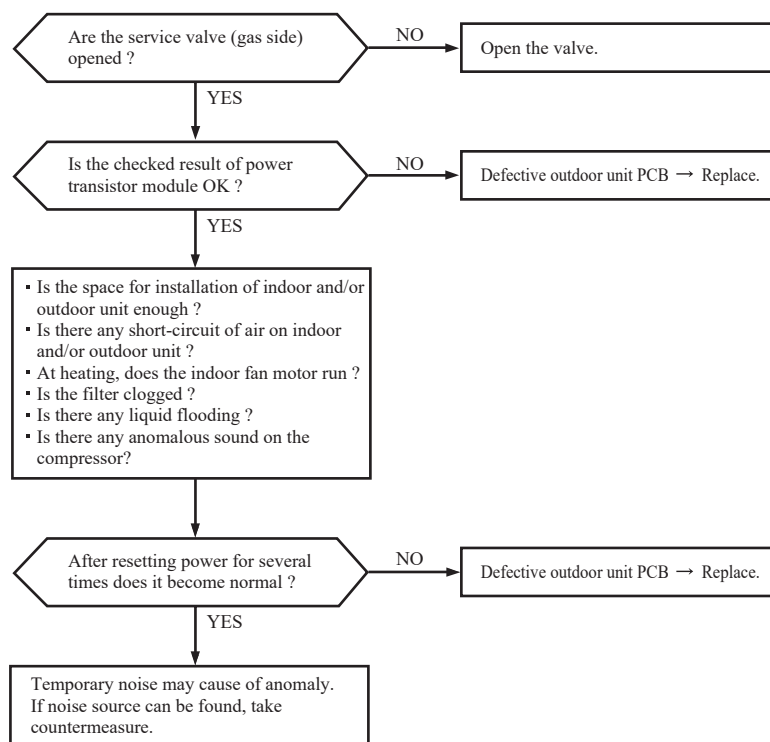

(8) Phenomenon observed after short-circuit, wire breakage on sensor

(a) Indoor unit

Sensor	Operation mode	Phenomenon	
		Short-circuit	Disconnected wire
Room temperature sensor	Cooling	Release of continuous compressor operation command.	Continuous compressor operation command is not released.
	Heating	Continuous compressor operation command is not released.	Release of continuous compressor operation command.
Heat exchanger temperature sensor	Cooling	Freezing cycle system protection trips and stops the compressor.	Continuous compressor operation command is not released. (Anti-frosting)
	Heating	High pressure control mode (Compressor stop command)	Hot keep (Indoor fan stop)
Humidity sensor	Cooling	Refer to the table below.	Refer to the table below.
	Heating	Normal system operation is possible.	

■ Humidity sensor operation

Failure mode	Control input circuit reading	Air-conditioning system operation
Disconnected wire	① Disconnected wire	Humidity reading is 0%. Anti-condensation control is not done.
	② Disconnected wire	
	①② Disconnected wire	
Short-circuit	① and ② are short-circuited	Humidity reading is 100%. Anti-condensation control keep doing.

Remark: Do not perform a continuity check of the humidity sensor with a tester. If DC current is applied, it could damage the sensor.

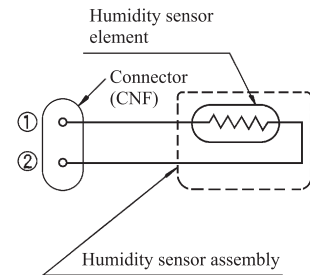

(b) Outdoor unit

Sensor	Operation mode	Phenomenon	
		Short-circuit	Disconnected wire
Heat exchanger temperature sensor	Cooling	Compressor stop.	Compressor stop.
	Heating	Defrost operation is not performed.	Defrost operation is performed for 10 minutes at approx. 35 minutes.
Outdoor air temperature sensor	Cooling	The compressor cannot pick up its speed owing to the current safe so that the designed capacity is not achieved.	Compressor stop.
	Heating	The compressor cannot pick up its speed owing to the heating overload protection so that the designed capacity is not achieved.	Defrost operation is performed for 10 minutes at approx. 35 minutes.
Discharge pipe temperature sensor	All modes	Compressor overload protection is disabled. (Can be operated.)	Compressor stop.

(9) Checking the indoor electrical equipment

(a) Indoor unit PCB check procedure

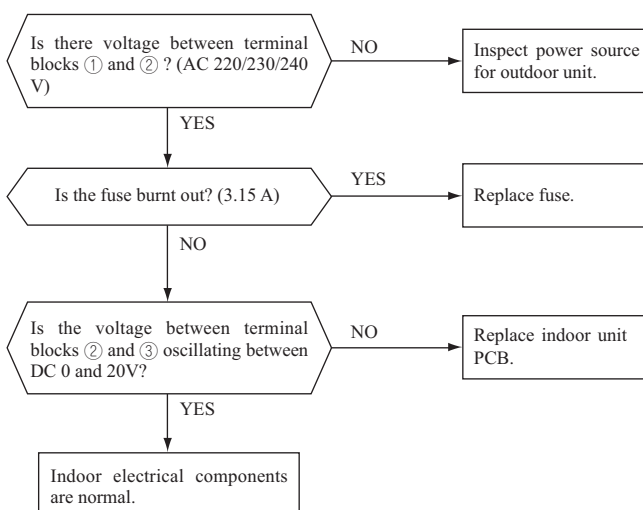

(b) Indoor fan motor check procedure

This is a diagnostic procedure for determining if the indoor fan motor or the indoor unit PCB is broken down.

1) Indoor unit PCB output check

- a) Turn off the power.
- b) Remove the front panel, then disconnect the fan motor lead wire connector.
- c) Turn on the power. If the unit operates when the ON/OFF button is pressed, if trouble is detected after the voltages in the following figure are output for approximately 30 seconds, it means that the indoor unit PCB is normal and the fan motor is broken down.

If the voltages in the following figure are not output at connector pins No. ①, ④ and ⑤, the indoor unit PCB has failed and the fan motor is normal.

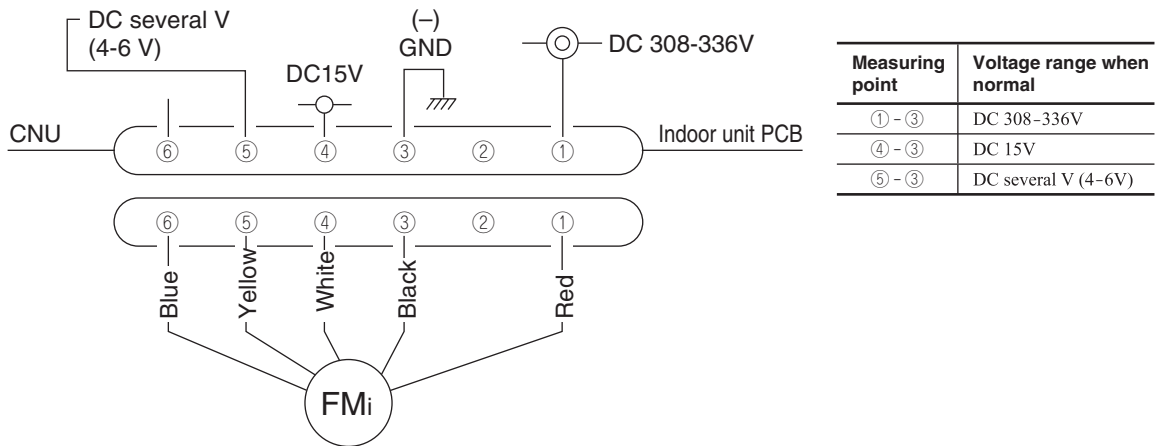

2) Fan motor resistance check

Measuring point	Resistance when normal
① - ③ (Red - Black)	20 MΩ or higher
④ - ③ (White - Black)	20 kΩ or higher

- Notes (1) Remove the fan motor and measure it without power connected to it.
 (2) If the measured value is below the value when the motor is normal, it means that the fan motor is faulty.

(10) How to make sure of wireless remote control

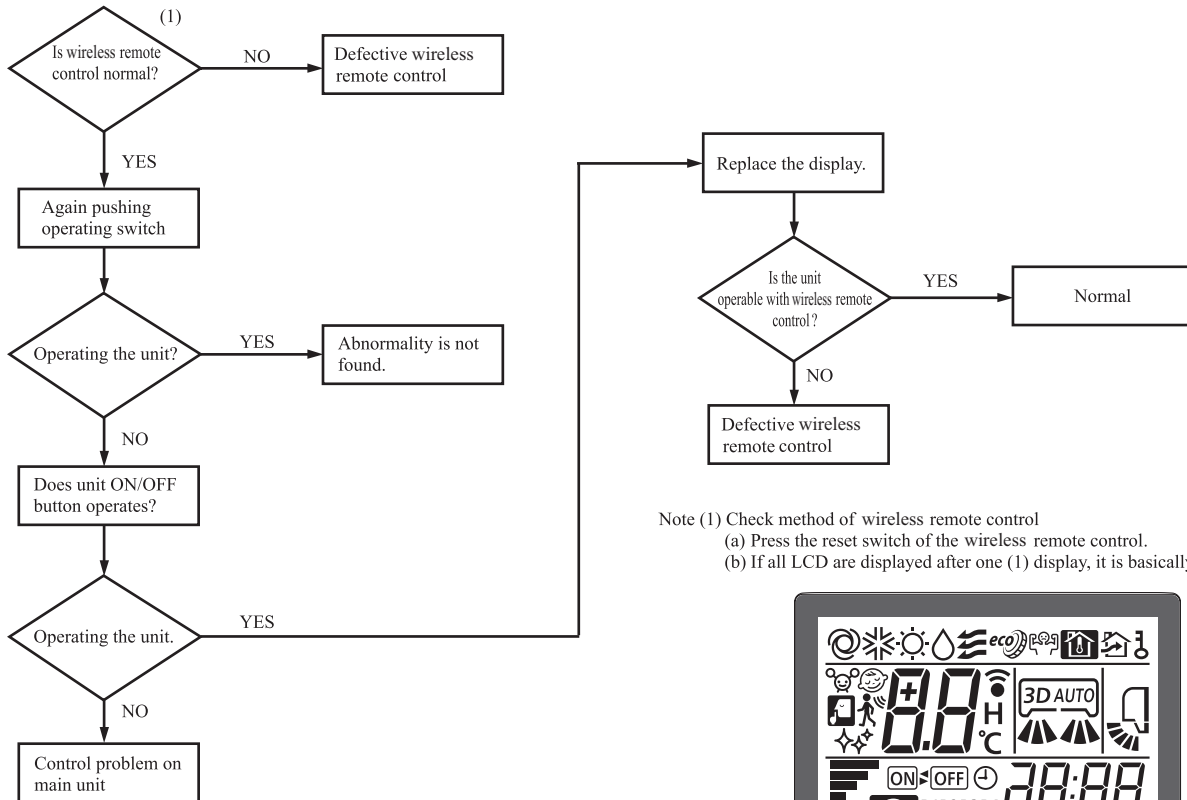

Note (1) Check method of wireless remote control
 (a) Press the reset switch of the wireless remote control.
 (b) If all LCD are displayed after one (1) display, it is basically normal.

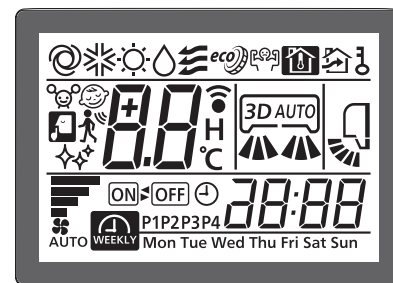

◆ Simplified check method of wireless remote control
 It is normal if the signal transmission section of the wireless remote control emits a whitish light at each transmission on the monitor of digital camera.

(11) Inspection procedure for blown fuse on the indoor and outdoor unit PCB

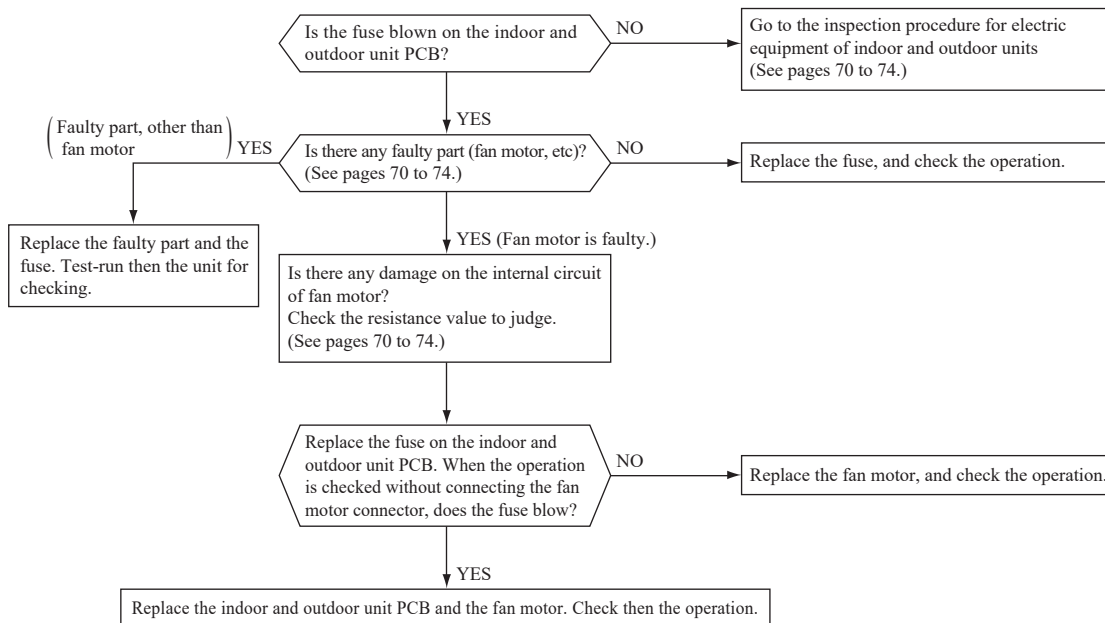

(12) Outdoor unit inspection points

Models SRC63ZR-W, 71ZR-W, 80ZR-W

◆ Check point of outdoor unit

⚠ CAUTION – HIGH VOLTAGE
 High voltage is produced in the control box. Don't touch electrical parts in the control box for 5 minutes after the unit is stopped.

Color symbol

Mark	Color
BK	Black
BL	Blue
RD	Red
WH	White
Y	Yellow
Y/G	Yellow / Green

◆ Voltage check in PCB
 The normal range is as follows.

Display	Voltage range
① DC280V	DC230V - DC310V
② DC 20V	DC 18V - DC 22V
③ DC 13V	DC 12V - DC 14V
④ DC 15V	DC 14V - DC 16V
⑤ DC 5V	DC 4V - DC 6V
⑥ DC 2.5V	DC 2.3V - DC 2.5V

◆ Inspection power transistor
 Remove the fasten terminal and test output voltage

◆ Power source and serial signal inspection

- ① to ② : AC 220/230/240V
- ① to ②/N : AC 220/230/240V
- ②/N to ③ : Normal if the voltage oscillates between DC 0 and approx. 20V

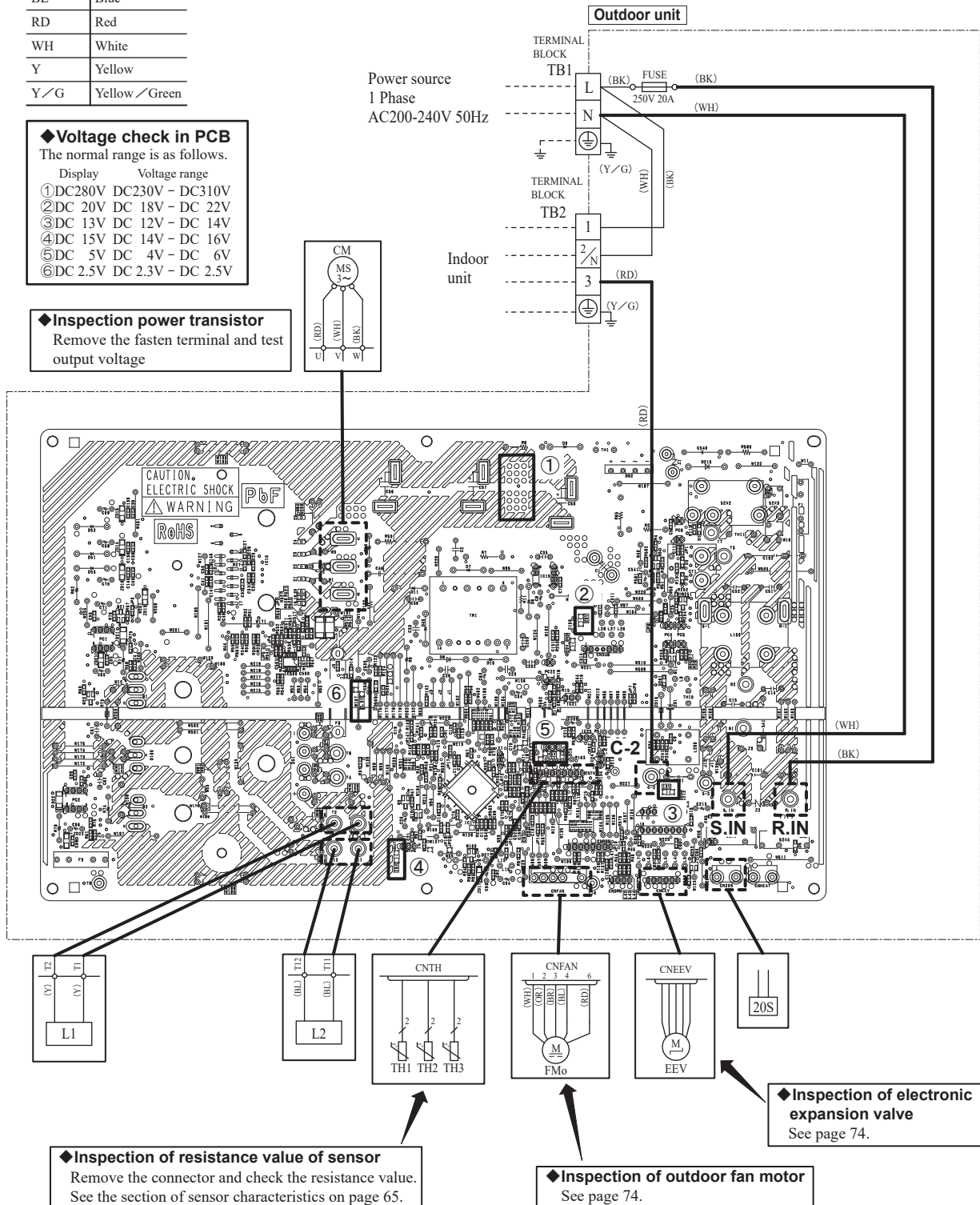

◆ Inspection of resistance value of sensor
 Remove the connector and check the resistance value. See the section of sensor characteristics on page 65.

◆ Inspection of outdoor fan motor
 See page 74.

◆ Inspection of electronic expansion valve
 See page 74.

(a) Inspection of electronic expansion valve

Electronic expansion valve operates for approx. 10 seconds after the power on, in order to determine its aperture. Check the operating sound and voltage during the period of time. (Voltage cannot be checked during operation in which only the aperture change occurs.)

- (i) If it is heard the sound of operating electronic expansion valve, it is almost normal.
- (ii) If the operating sound is not heard, check the output voltage.

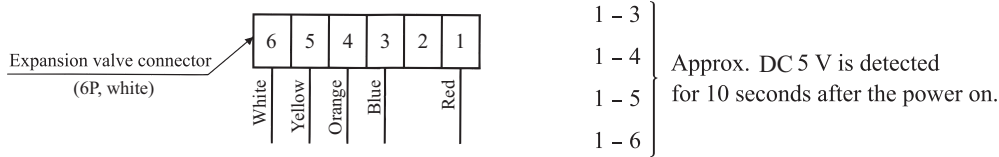

- (iii) If voltage is detected, the outdoor PCB is normal.
- (iv) If the expansion valve does not operate (no operating sound) while voltage is detected, the expansion valve is defective.

• Inspection of electronic expansion valve as a separate unit

Measure the resistance between terminals with an analog tester.

Measuring point	Resistance when normal
1-6	46 ± 4Ω (at 20°C)
1-5	
1-4	
1-3	

(b) Outdoor fan motor check procedure

- When the outdoor fan motor error is detected, diagnose which of the outdoor fan motor or outdoor unit PCB is defective.
- Diagnose this only after confirming that the indoor unit is normal.

(i) Outdoor unit PCB output check

- 1) Turn off the power.
- 2) Disconnect the outdoor fan motor connector CNFAN.
- 3) When the indoor unit is operated by inserting the power source plug and pressing (ON) the backup switch for more than 5 seconds, if the voltage of pin No. ② in the following figure is output for 30 seconds at 20 seconds after turning “ON” the backup switch, the outdoor unit PCB is normal but the fan motor is defective.

If the voltage is not detected, the outdoor unit PCB is defective but the fan motor is normal.

Note (1) The voltage is output 3 times repeatedly. If it is not detected, the indoor unit displays the error message.

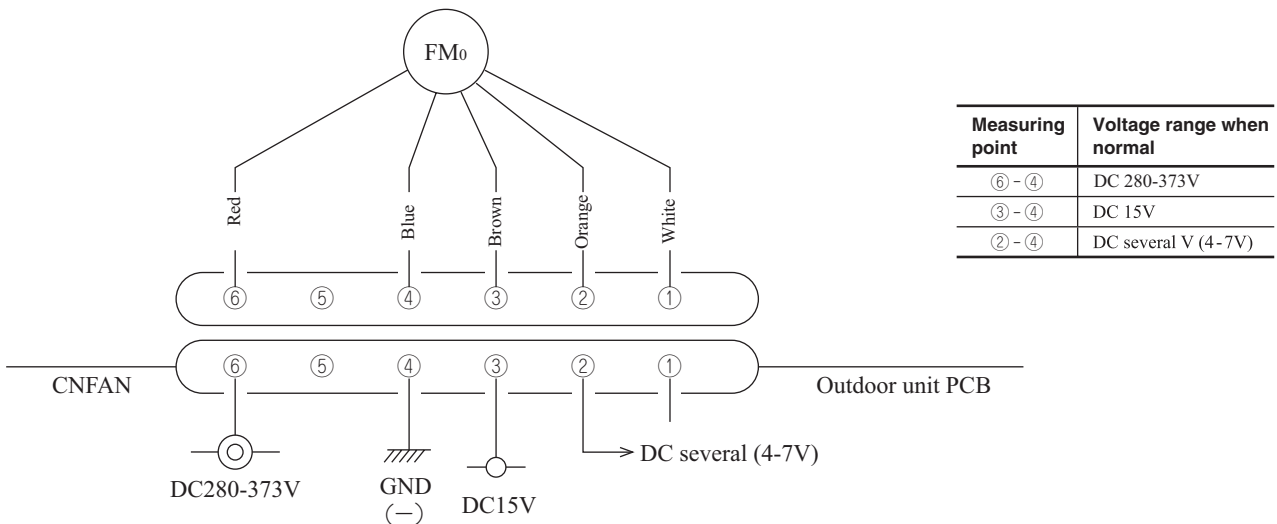

(ii) Fan motor resistance check

Measuring point	Resistance when normal
⑥ - ④ (Red - Blue)	20 MΩ or higher
③ - ④ (Brown - Blue)	20 kΩ or higher

- Notes (1) Remove the fan motor and measure it without power connected to it.
- (2) If the measured value is below the value when the motor is normal, it means that the fan motor is faulty.

11. INDOOR UNIT DISASSEMBLY METHOD

(1) Remove the cover.

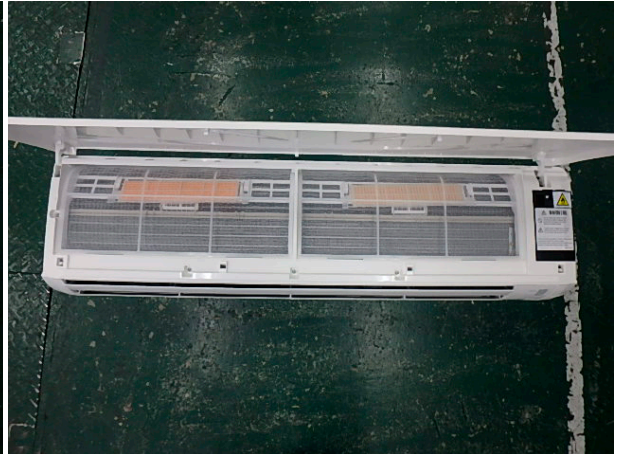

(2) Remove the screw (The following 5 places).

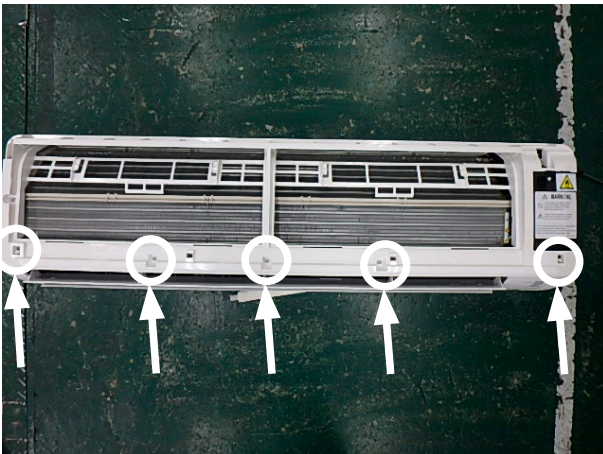

(3) Remove the cover.



(4) Unplug the connector.

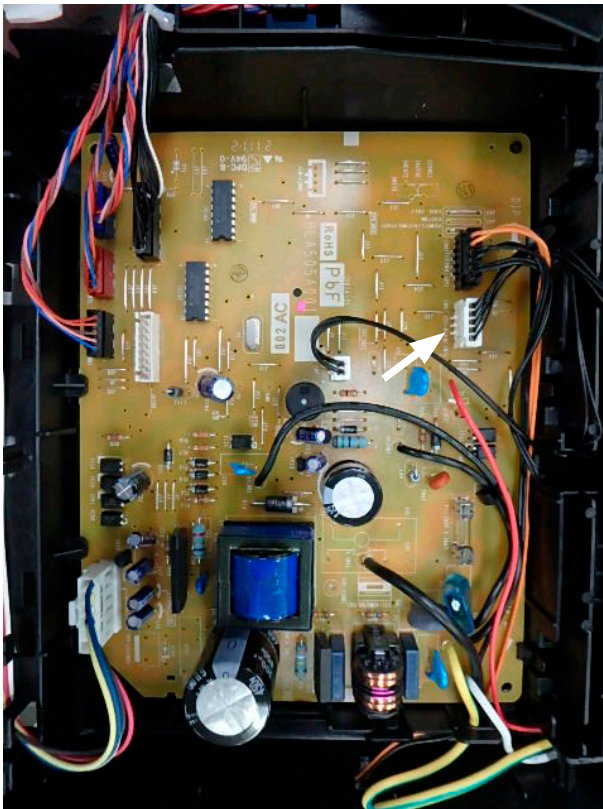

(5) Unscrew.

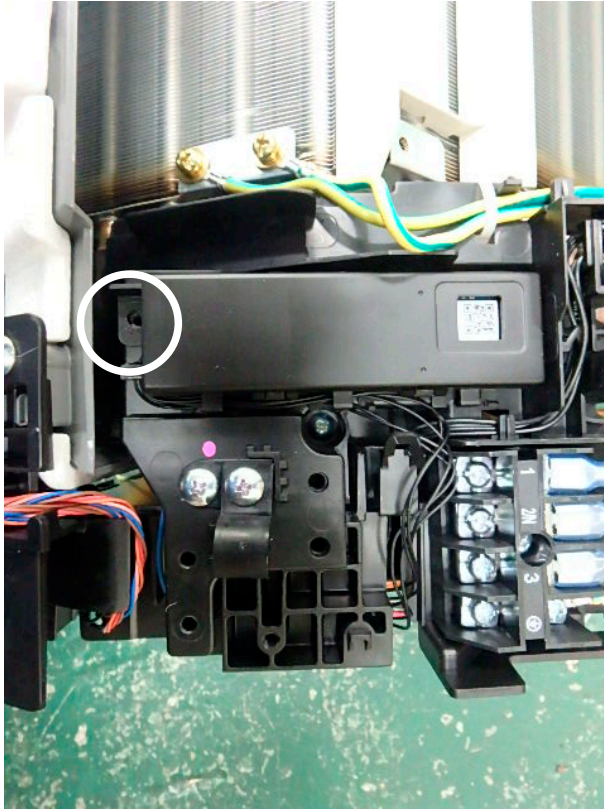

(6) Pull out control.

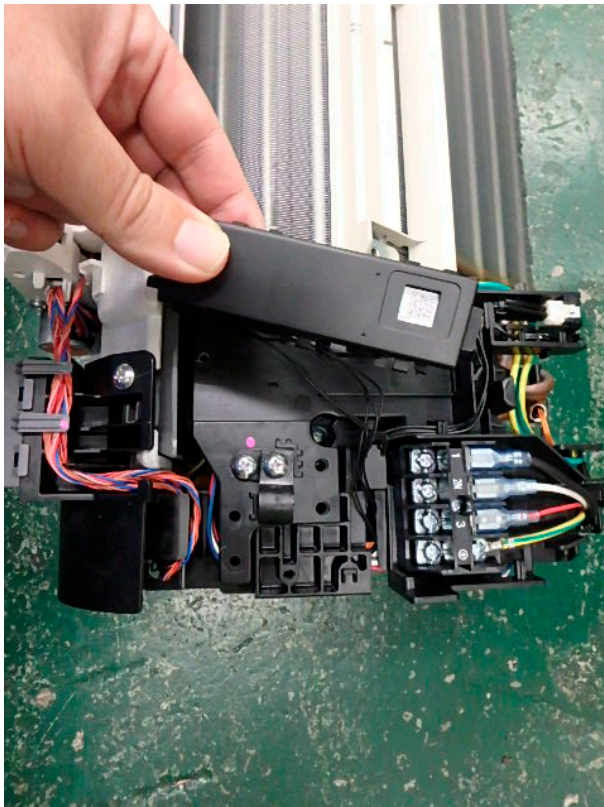

SRK63-80ZR-WF Operation table

Function	Setting	Operation by remote control	Operation by Smart M-Air	Operation by wired remote control (SC-BIKN2) *1
ON/OFF	ON	○	○	○
	OFF	○	○	○
OPERATION MODE select	AUTO	○	○	○
	COOL	○	○	○
	HEAT	○	○	○
	DRY	○	○	○
	FAN	○	○	○
	SELF CLEAN	○	×	×
	ALLERGEN CLEAR	○	×	
	NIGHT SETBACK	○	×	
	Home leave mode	—	○ *2	○
	Vacant property mode	—	○	—
Temperature adjustment	18°C—30°C	○	○	○
FAN SPEED	AUTO	○	○	○
	HIGH POWER	○	×	
	Hi	○	○	
	Me	○	○	
	Lo	○	○	
	ULo	○	○	
	ECONO	○	×	
Air flow direction adjustment	Up/down (1 step)	○	○	○
	Up/down (2 step)	○	○	○
	Up/down (3 step)	○	×	
	Up/down (4 step)	○	○	
	Up/down (5 step)	○	○	
	Up/down (swing)	○	○	○
	Up/down (flap stopped)	○	×	
	Left/right (leftmost)	○	○	○
	Left/right (left)	○	○	○
	Left/right (middle)	○	○	○
	Left/right (right)	○	○	○
	Left/right (rightmost)	○	○	○
	Left/right (wide)	○	○	○
	Left/right (spot)	○	○	○
	Left/right (swing)	○	○	○
	Left/right (louver stopped)	○	×	
3D AUTO	○	○	○	
TIMER function	Various TIMERS	○	—	○
	WEEKLY TIMER	○	○	○
MENU function	Display brightness adjustment	—	—	—
	Fan control in heating thermo-OFF	—	—	○ *3
	SELF CLEAN setting	○	—	—
	Silent setting	—	—	—
	Wireless LAN connection setting	○	—	—
Other function	Wireless LAN communication	○	—	—
	Installation location setting	○	—	—
	Silent	○	—	○
	Initialization of wireless LAN	○	—	—
	Electricity bill display	—	○	○
Shut-off reminder alert	—	○	—	

○ : Operation/Setting Available
 × : Operation/Setting/Display N/A
 — : No function

*1 : Option part
 *2 : Operates with the default settings of the indoor unit
 (Operation switching is cooling or heating display)
 *3 : Only fan stop can be set.

12. WIRELESS LAN INTERFACE SETTING MANUAL

- This document describes how to connect to network via Wireless LAN.
- Read this manual carefully, and store it in a safe place after reading.
- Be sure to also read the “Safety precautions” in the user’s manual included with the product.
- The contents of the application ”Smart M-Air” may change due to version upgrade.

Note on Wireless Communication (Radio Wave)

Wireless LAN and Radio Act

- This product has construction design certification. Therefore, application for the licence is not necessary.
- This product is certified to meet the technical standard as a wireless facility of a specified low-power radio station based on the Radio Act. Therefore, a radio station licence is not necessary when using this product.
- Wireless LAN may be subject to wiretapping or malicious access because it transmits and receives data using radio waves. Before using wireless LAN, thoroughly understand the risk. In addition, manage the SSID and KEY of this product and wireless LAN router and also the log-in ID and password for operation away from home so as to prevent them from being known by other people. In the event that the product is operated away from home by malicious access, turn OFF the function of the wireless LAN communication. (See the section “Wireless LAN communication setting” in the USER’S MANUAL.)
- This product cannot be connected directly to communication lines provided by telecommunication carriers. When connecting this product to the internet, be sure to connect it to the internet via a router.
- If a barrier that restricts radio waves (such as metal or reinforced concrete) is located between this product and a wireless LAN router the product may not operate due to interference, or a reduction in communication distance.
- Use of this product near a device emitting electric waves such as a microwave oven or cordless phone may affect communication via wireless LAN. If the product fails to communicate properly, or if a cordless phone fails to send/receive a call properly, be sure to use the product and the phone at least 1 metre away from each other.
- If you have any other problems, consult the sales outlet for the product.

RSA012A132

Preparation before connection

Prepare the following items.

- Smartphone (tablet PC)
Supported OS
Android™ 8 to 10
iPhone 12 to 14
- Internet line and communication equipment
(modem, router, ONU etc.)
- Router (wireless LAN access point)
A product that supports a 2.4 GHz band
- SSID, KEY, and MAC address
The SSID and KEY confirmation method is described in section 6
- Your home Wi-Fi network password

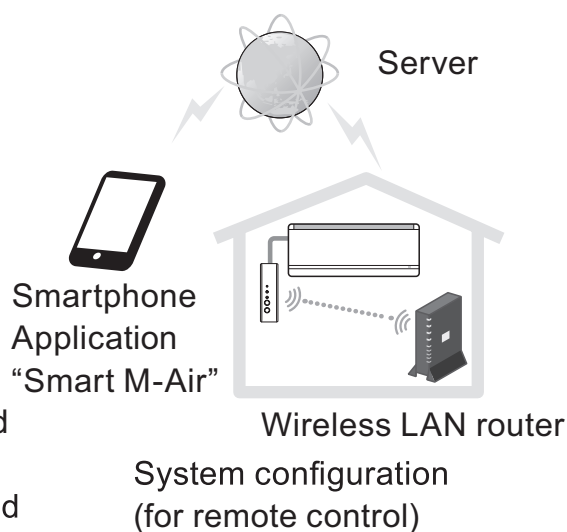

Connect the smartphone (tablet PC) to the router via Wi-Fi.

Open "Wi-Fi" on the settings screen of the smartphone, and select SSID of the router to be used. Then, establish the connection by entering the password of the router.

(1) Install the application.

How to install "Smart M-Air"

How to install the "Smart M-Air" smartphone application	
For Android 1. Open [Google Play]. 2. Search for [Smart M-Air]. 3. Install the application according to the instructions on the screen.	For iOS (iPhone) 1. Open [App Store]. 2. Search for [Smart M-Air]. 3. Install the application according to the instructions on the screen.

- The application is free. Communication data charges by others are applied to download and operate.
- The application name "Smart M-Air" and download service names "Google Play" and "App Store" may be changed in the future.
- For the settings, contents, and latest supported OS of the application, refer to our home page or the User's Manual on our home page.

(2) Confirm connection method of router

WPS (Simple setting function): Add a new device to the network using WPS button on router.

AP: Add a new device to the network by connecting to the router using SSID and Key (Password).

(3) Creating user account

- 1) Smartphone setting
Turn on Wi-Fi of your smartphone and connect smartphone and router.
- 2) Application initial setting
Initial application settings and the application starts.
- 3) After startup, the “Language / Time Zone Setting” screen appears.

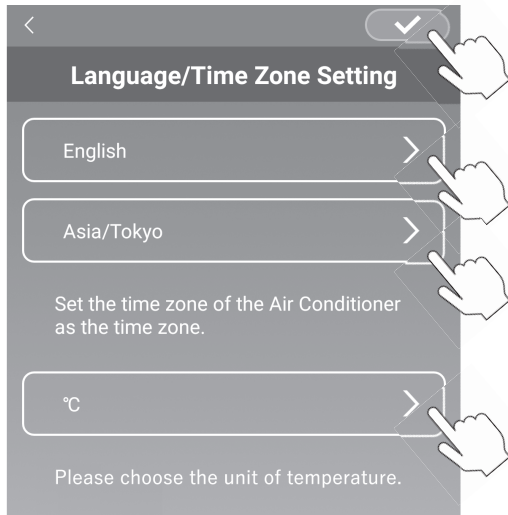

Select which language to use in the application.
 Select the region in which the air conditioning unit is installed.
 Select the unit of temperature displayed in the application.
 Finally, tap  on the top right to complete the setting.

- 4) The “Terms of Service” screen appears. Read and check the statement in full. To consent and proceed with using the application tap [Agree]. Selecting [I don't agree] will exit the application.

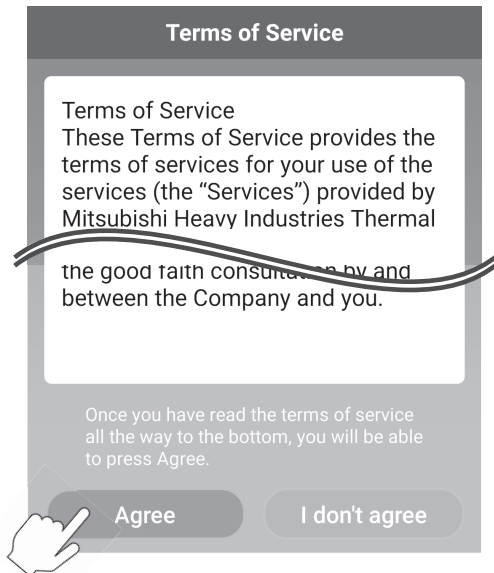

Android

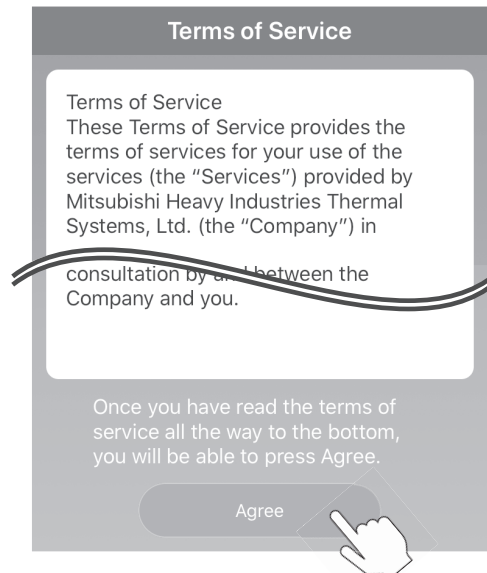

iOS

- 5) The “Startup” screen appears.
Tap [Operate Air Conditioner].



- 6) The “Log in” screen appears.
Tap [Create an Account].
The “Handling of Personal Information” screen appears.
Read and check the statement in full. To consent and proceed with using the application tap [Agree].

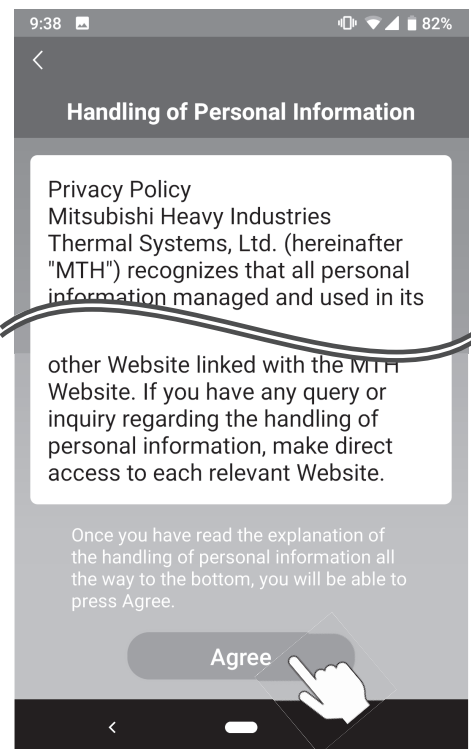
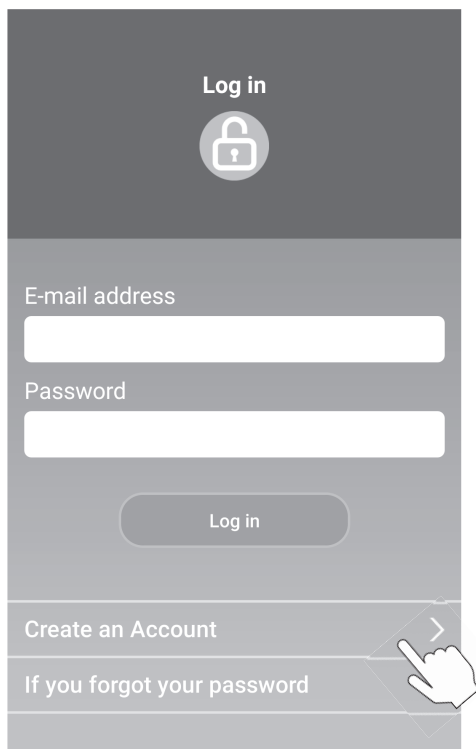

- 7) The “Create an Account” screen appears.
Enter your e-mail address and password
Tap the [Create an Account] button.
The pop-up message “Create an Account” appears, to confirm tap [OK].

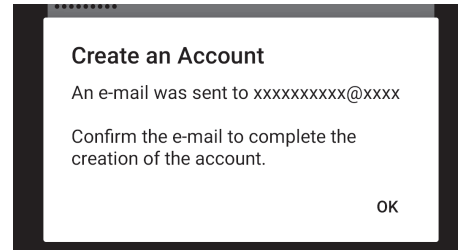
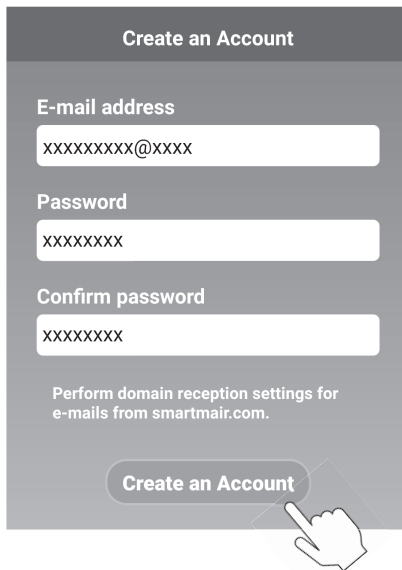

<Note>
A password must be between 8 to 16 characters including at least one alphabetic character and one numeric character.

An e-mail containing a link to confirm registration will be sent to the e-mail address provided which will expire after 24 hours. Click the link within the e-mail to complete account creation.

- 8) After creating an account the “Log in” screen is displayed when opening the application. Enter the registered e-mail address and password, and tap the [Log in] button.

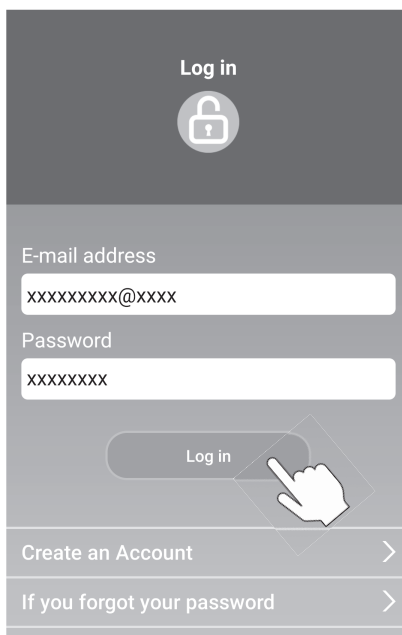

<Note>
To reset your password tap “If you forgot your password”.

(4) Confirming the connection method with the wireless remote control (WPS/AP)

1) Please confirm the “Air Conditioner List” screen is displayed.

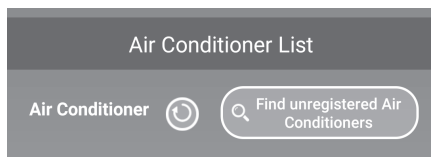

<Note>
If [Find unregistered Air Conditioners] button is not displayed confirm that section 3 step (1) has been performed correctly.

- 2) The Wireless LAN connection setting cannot be set whilst the unit is running. To turn off the air conditioner press the ON/OFF button on the wireless remote control.
- 3) Select the Wireless LAN connection setting “SL” by pressing the MENU switch on the wireless remote control.
- 4) Based on the router specifications confirmed in section 2, select “E1” (WPS mode) or “E2” (AP mode) using the ▲ and ▼ (TIMER) buttons on the wireless remote control.



<Note>
After performing step 5) below, it is necessary to complete up to step 5 (A) 3) within 2 minutes for WPS mode, and up to 5 (B) 3) within 5 minutes for AP mode.
Prepare the necessary information (SSID, KEY, MAC address, and your home Wi-Fi network password) in advance.

- 5) Press the SET button on the wireless remote control.
The indoor unit will emit “peep pip” to confirm setting of parameters, then the RUN and TIMER lights will also blink simultaneously at 1 second ON, 1 second OFF.
If no sound is emitted by the unit, return to step (3) and repeat the process.

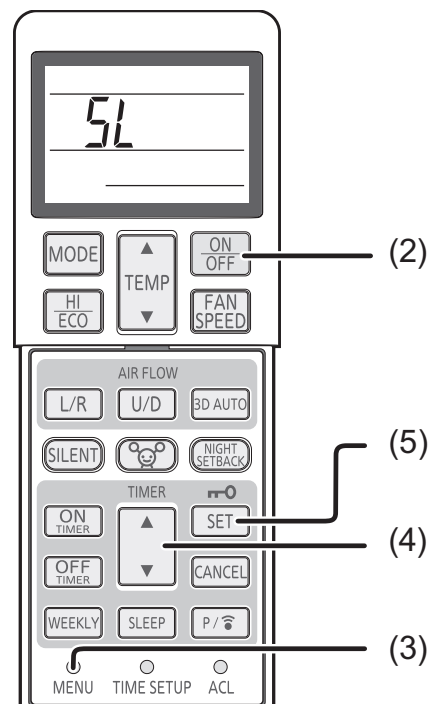

Wireless remote control

(5) Connect the air conditioner to the network.

The connection process will vary depending on the router specifications (WPS/AP).

See item (A) for WPS, and item (B) for AP.

(A) Connect the air conditioner to the network with WPS function

- 1) Press the WPS button.

Press the WPS button on the router*. The buttons generally look like this.

Operation to connect to the router using WPS may vary, refer to manufacturers installation guide for instructions.

* If using an automatic connection function other than WPS, refer to manufacturers installation guide.

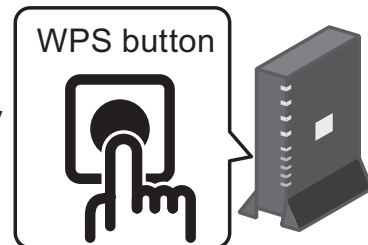

- 2) Use the “Air Conditioner List” screen to register an air conditioner to operate.

Tap the [Find unregistered Air Conditioners] button to display unregistered air conditioners on the application.

The air conditioner name displays the last 6 digits of the SSID in the position indicated by in the image below. (Refer to section 6 for instructions on confirming SSID.)



If it is not displayed, confirm again that the steps following section 4 have been performed properly.

- If it is not connected, wait at 2 minutes until the RUN and TIMER light on the indoor unit are no longer lit and repeat process from section 4.
- If the air conditioner still cannot be connected to the application, the number of devices connected with the wireless LAN router may have reached its upper limit, or the router may not be operating or may have failed. Therefore, check the wireless LAN router according to the user’s manual of the router.
- If the air conditioner cannot be connected to the application even by following the setting procedure in this manual, refer to FAQ in the menu of the application.

- 3) Tap the [Enter] button to select the air conditioner you want to add.
Tap the [YES] the displayed pop up message to confirm.

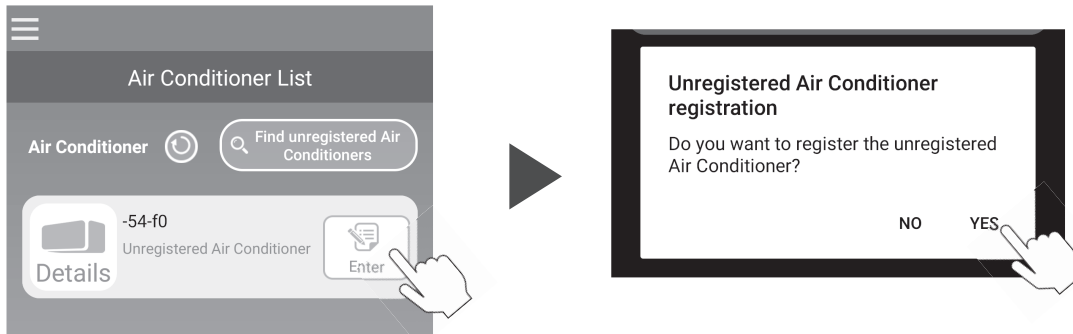

The following screen will be displayed when registration is complete.

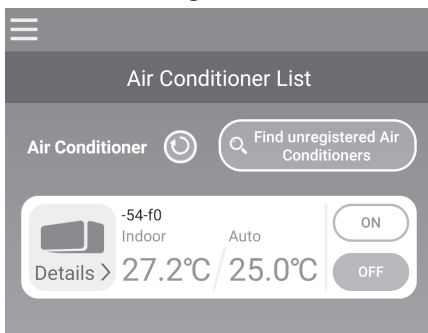

(B) Connect the air conditioner to the network with AP

- 1) Change the Wi-Fi connection destination of your smartphone to enter “Smart M-Air-XXXX”* and KEY.
*XXXX indicates the last 4 digits of the MAC address for the air conditioner.
KEY and MAC address confirmation method is described in section 6.
- 2) On the “Air Conditioner List” screen, tap the [Find unregistered Air Conditioners] button.

To add the air conditioner tap the [Settings] button.

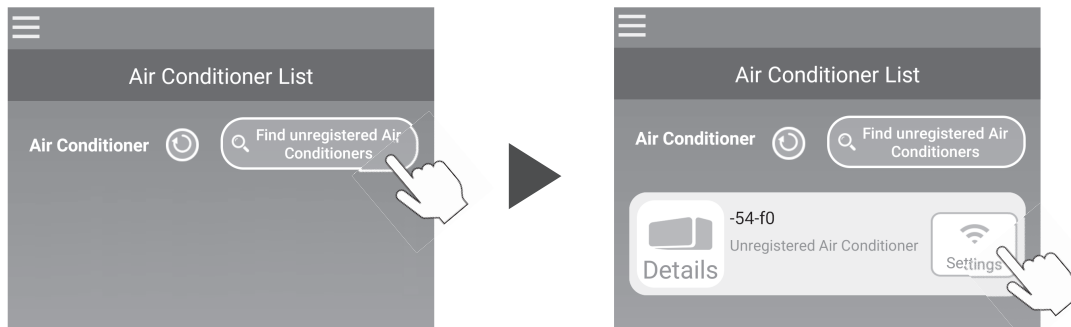

If the air conditioner is not displayed, repeat steps in section 4.

- If it is not connected, wait at 5 minutes until the RUN and TIMER light on the indoor unit are no longer lit and repeat process from section 4.
 - If the air conditioner still cannot be connected to the application, the number of devices connected with the wireless LAN router may have reached its upper limit, or the router may not be operating or may have failed. Therefore, check the wireless LAN router according to the user’s manual of the router.
 - If the air conditioner still cannot be connected to the application after following the procedure in this manual, then refer to the FAQ section in the application menu.
- 3) If prompted to permit access to location information, please permit.

After selecting the network to connect to from the displayed list, the SSID will be pre-populated* in the entry field at the bottom of the screen.

Next, enter your home Wi-Fi network password and tap the  at the top of the screen to confirm.

*If the home Wi-Fi network SSID number is not input automatically then it will need to be entered manually.

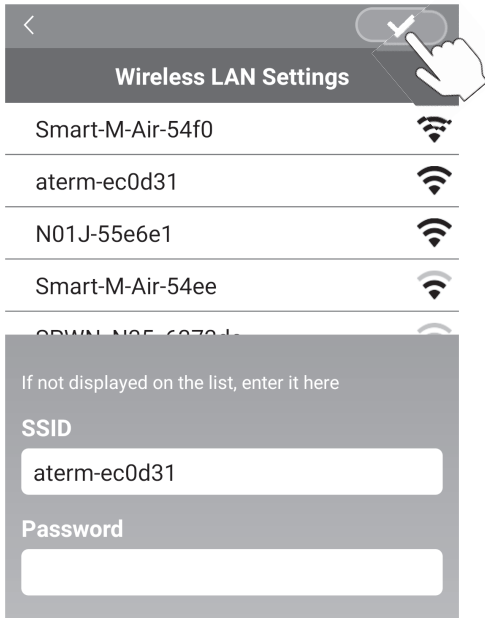

Android

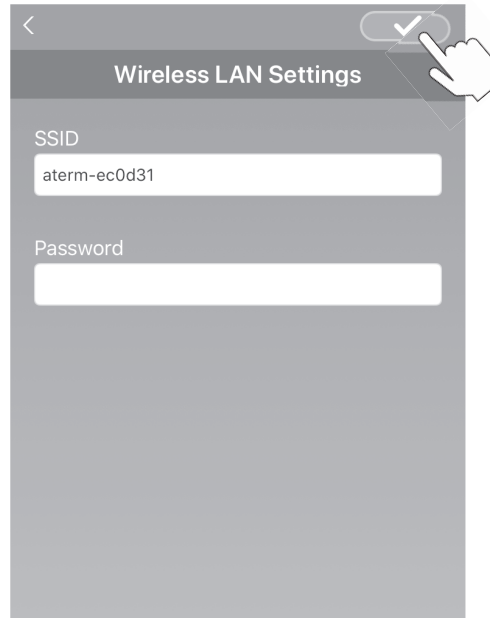

iOS

The pop-up screen will appear to confirm air conditioner has been added. Tap the [OK] button to continue, the following screen will then be displayed showing the unit has been added.

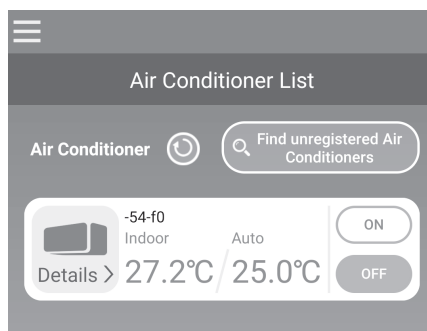
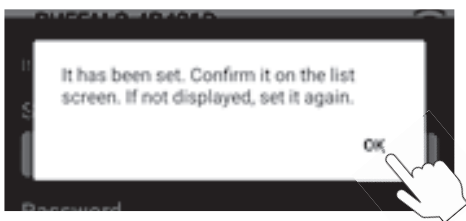

(6) SSID, KEY and MAC address confirmation method

SSID, KEY and MAC address are printed on the label attached to the front of the indoor unit. Attach the label to this manual and keep it. This can also be viewed by scanning the QR code on the label.

<Note>

There is also a label showing this information inside the inlet panel.

See the section “Name of each part and its function” in the USER’S MANUAL for label location.

See the section “Maintenance” in the USER’S MANUAL for instructions to open the inlet panel.

Label attachment position

“iPhone” is a trademark of Apple Inc. registered in the U.S. and other countries.

App Store is a service mark of Apple Inc.

“Android™” and “Google Play” are trademarks or registered trademarks of Google LLC.

Other company names and product names that appear in this manual are trademarks or registered trademarks of their respective companies.

13. APPLICATION OPERATION MANUAL

Smart M-Air

Operation Manual

Table of contents

(1) Application features	93
(2) Manipulation modes	95
Remote operation mode	95
Home restricted mode	95
Demo mode	95
(3) Preparation for use	96
Smartphone setting	96
Application initial setting	96
Creating user account	98
Registering air conditioner	101
Wireless LAN settings of air conditioner	102
Naming air conditioner	104
(4) Basic usage	106
Starting / Stopping air conditioner operation	106
Switching operation mode	106
Changing temperature	107
Changing fan speed and air flow direction	108
Switching Vacant Property Mode	109
(5) Using Favourites	110
(6) Using Options	114
Shut-off reminder alert	115
Air conditioner error notification	116
Hi temp/low temp alert	117
Watching function	118
Home leave mode	118
Cooling specific	120
LED ON	120
Number of smartphones	120

(7)	Setting Weekly Timer	121
(8)	Setting Timer by Specifying Date via Calendar	123
	Clear the timer set from the calendar	124
(9)	Displaying Electricity Bill Graph	126
(10)	Updating Firmware	127
(11)	Main Menu	129
	Canceling demo mode	130
(12)	Checking Alerts	131
(13)	Changing Application Settings	133
	Switch Operation Modes	134
	Switching to “Remote operation mode”	134
	Switching to “Home restricted mode”	135
	Reset Password	137
	Language/Time Zone Settings	139
	Application Initialization	140
	Application Version Display	142
(14)	Troubleshooting	143
	When the air conditioner that you want to register does not appear in the air conditioner list screen	143
	How to delete a registered air conditioner	144
	When an abnormality notification appears in the air conditioner list	145
	When you forget your password and cannot log in	145
	When operation is performed by another account	146
	When "Shut-off reminder alert" does not turn on (For Android OS)	146

(1) Application features

You can operate the air conditioner in each room at home or from outside.

- Setting operation reservation of every day of the week for each air conditioner
- Checking the power consumption of an air conditioner
- Setting the shut-off reminder alert
- Alerting if an air conditioner is abnormal

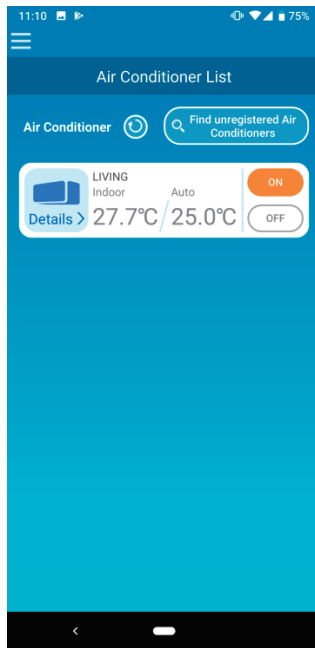

Figure 1-1



Figure 1-2

Note

Depending on the function of the connected air conditioner, the following operation will not be reflected in the operation of the air conditioner.

- Left/Right, 3D AUTO, Home leave mode, Electricity Bill Graph

Depending on the function of the connected air conditioner, the following operation will not appear on the screen:

- Home leave mode setting, LED ON

When the wireless LAN interface is connected, the timer setting is disabled on your home remote control depending on your air conditioner.

Please use the timer function of the application to set the timer.

(2) Manipulation modes

- Remote operation mode

This mode allows you to operate the registered air conditioner via the smartphone application when you are out of the office.

Also, you can register and operate the air conditioner at home through a smartphone application.

- Home restricted mode

This mode allows you to register and operate the air conditioner at home via the smartphone application.

You can operate without data communication to the server.

Operation is not available when you are out.

- Demo mode

If you don't have an air conditioner compatible with a smartphone app, This mode allows you to experience the operation feel of remote operation mode.

(3) Preparation for use

- Smartphone setting

Turn on Wi-Fi of your smartphone.



Figure 3-1

- Application initial setting

Tap the Smart M-Air icon.



Figure 3-2



Figure 3-3

The application starts.

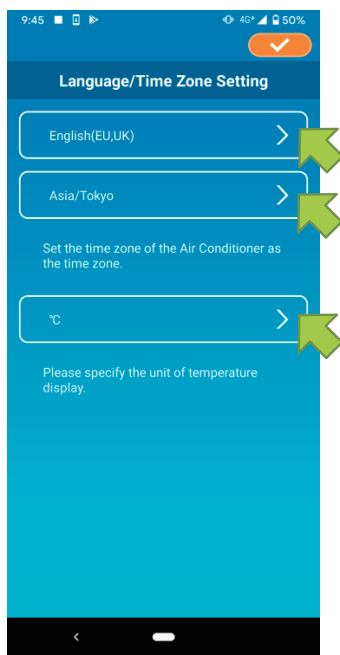



Figure 3-4

After startup, the “Language/Time Zone Settings” screen appears.

Select a language to use in the application.

Select a time zone. Select the time zone in which the air conditioner to operate via the application exists.

Choose the unit of temperature.

Finally, tap  on the top right to complete the setting.

The “Terms of Service” screen appears. Read the text to the bottom and check the description. If you agree it and use the application, tap [Agree]. When you tap [I don’t agree], the application exits.

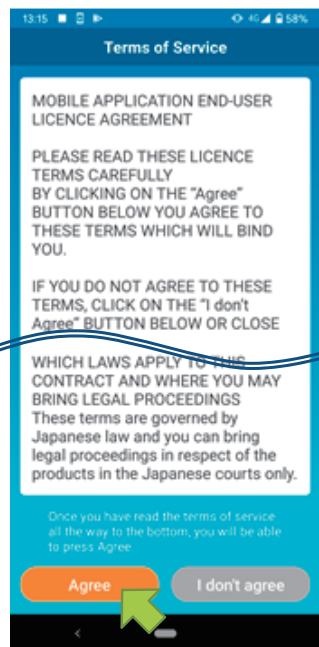

Android

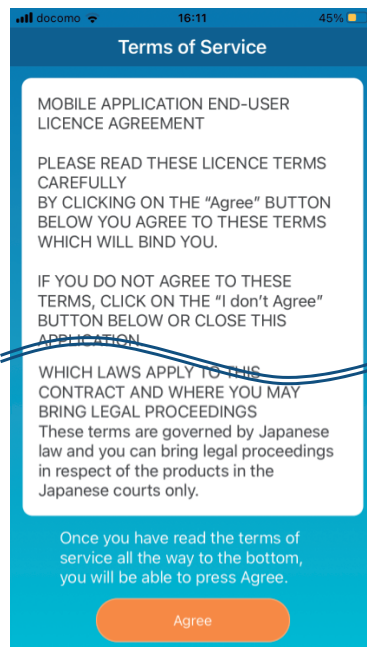

iOS

Figure 3-5

On the startup screen, select a mode to use.

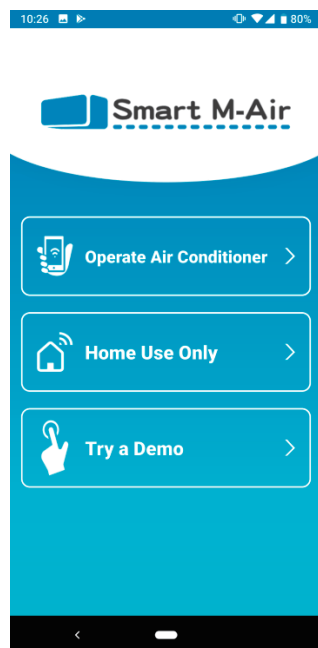

Figure 3-6

- Operate Air Conditioner (Remote operation mode)

Tap "Operate Air conditioner" for remote control or to use optional functions such as weekly timer.

→ To ["Creating user account"](#)

- Home Use Only (Home restricted mode)

Tap "Home Use Only" to operate only at home. Some functions are restricted, but you can change to remote operation mode at any time.

→ To ["Registering air conditioner"](#)

Switching operation mode

→ To ["Changing Application Settings"](#)

- Try a Demo (Demo Mode)

Tap "Try a Demo" to try out the app's features. (Some features only)

→ To ["4. Basic Usage"](#)

- Creating user account

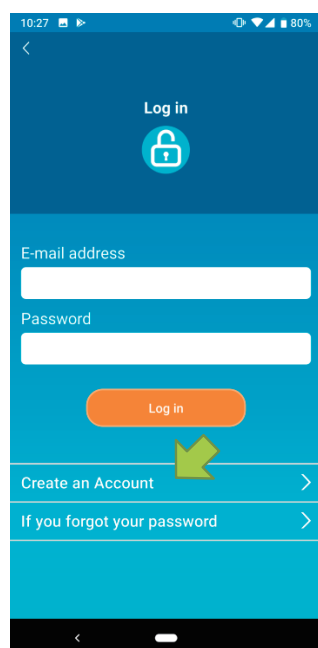

Figure 3-7

Tap [Create an Account].



Figure 3-8

Read the text of Handling of Personal Information to the bottom and check the description.

If you agree it and use the application, tap [Agree].

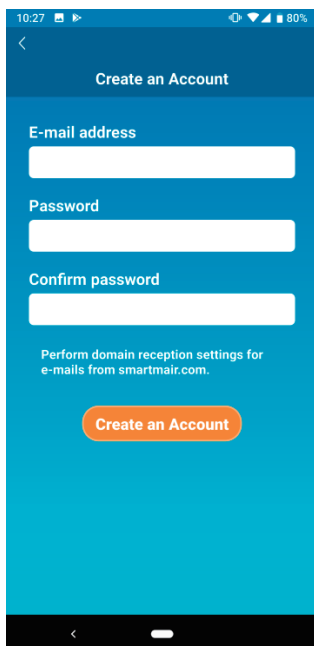

Figure 3-9

The “Create an Account” screen appears. Enter your e-mail address and password and tap the [Create an Account] button.

Note

- A password must be between 8 to 16 characters including at least one alphabetic character and one numeric character.

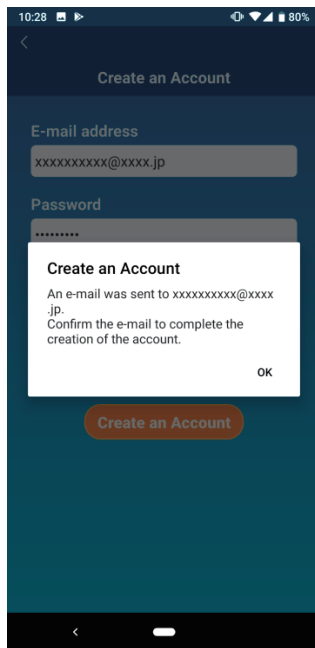

Figure 3-10

When the pop-up message “Create an Account” appears, tap [OK].

The email containing the URL of the authentication screen will be sent to the email address you entered, so please click the URL within 24 hours to complete the account creation.

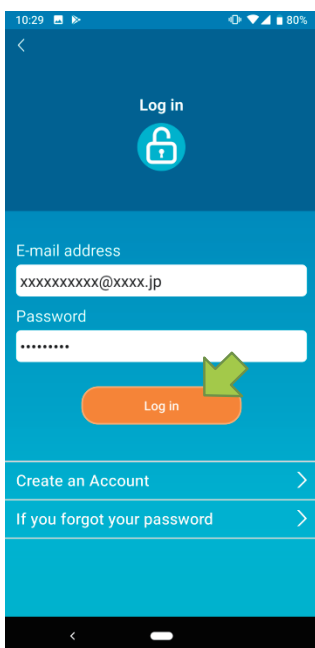

Figure 3-11

After the account is created, the “Log in” Screen appears on the application.

Click the URL written in the e-mail, enter the registered e-mail address and password, and tap the [Log in] button.

If you forget your password and cannot log in, tap "If you forgot your password" and set a new password.

→ To [“Reset Password”](#)

• Registering air conditioner

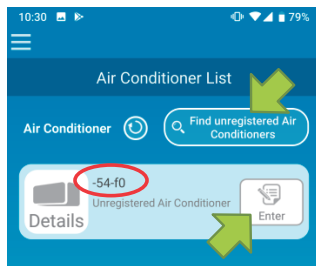

Figure 3-12

Use the “Air Conditioner List” screen to register an air conditioner to operate.

Tap the "Find unregistered Air Conditioners" button to display air conditioners that are not registered on your smartphone.

The air conditioner name (○ locations) displays the last 6 digits of the SSID on the label of the wireless LAN interface.

Tap the [Enter] button.

- When the air conditioner is not displayed on the list screen
→ To [“When the air conditioner that you want to register does not appear in the air conditioner list screen”](#)
- To delete a registered air conditioner
→ To [“How to delete a registered air conditioner”](#)

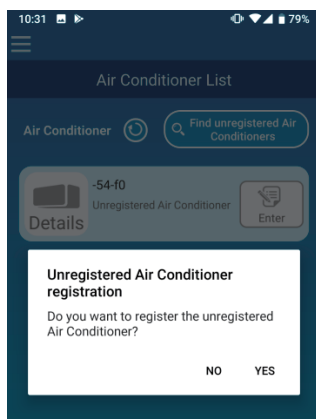

Figure 3-13

To register the air conditioner, tap [YES] on the pop-up message displayed.

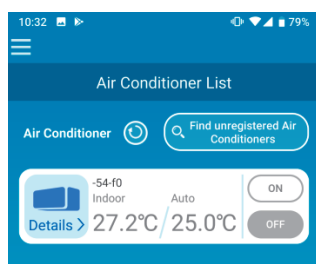

Figure 3-14

- Wireless LAN settings of air conditioner

If your wireless LAN router does not support WPS, manually make wireless LAN settings of your air conditioner.

Set the wireless LAN interface to the AP mode, and then change the Wi-Fi connection destination of your smartphone to “Smart-M-Air-XXXX”.

“XXXX” is the last 4 alphanumeric characters of the MAC address of the wireless LAN interface.

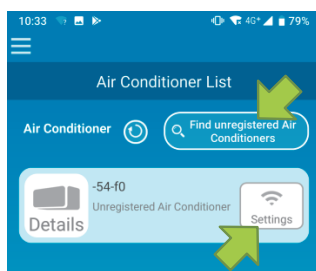

Figure 3-15

On the “Air Conditioner List” screen, tap the [Find unregistered Air Conditioners] button. The target air conditioner appears.

Tap the [Settings] button.

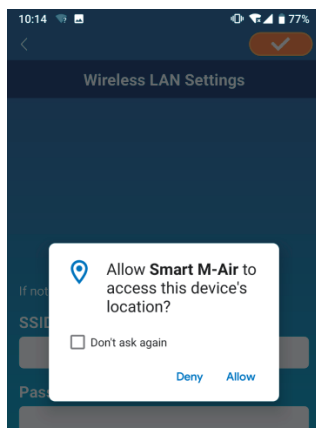



Figure 3-16

If you are prompted to permit access to location information, tap [Allow].

When you tap the network you want to set from the displayed list, the SSID appears in the "SSID" entry field at the bottom of the screen, enter "Your home Wi-Fi password" below it, and tap  in the top right.

If the network you want to set is not displayed in the list, enter "SSID" and "Your home Wi-Fi password" directly, then tap  on the top right to set.

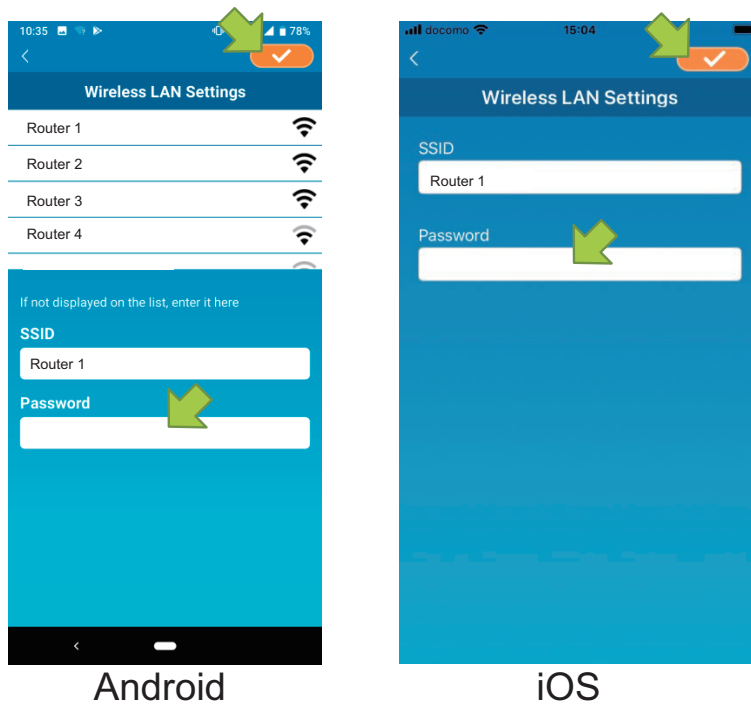

Figure 3-17

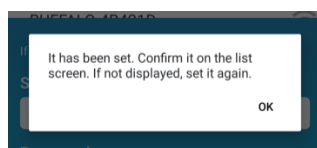

Figure 3-18

After the wireless LAN settings is completed, the air conditioner is registered.

- Naming air conditioner

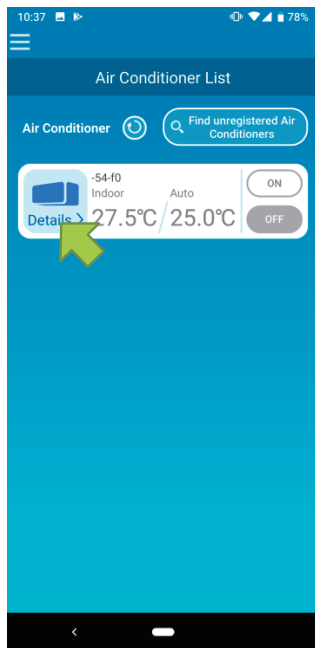

Figure 3-19

If you want to change the name of the air conditioner displayed in the application such as the air conditioner list screen, tap "Details" to display the detailed screen of the air conditioner.

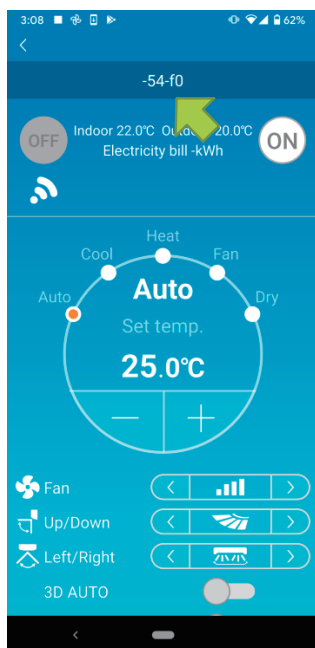

Figure 3-20

Press and hold down (1 second) an air conditioner name. The “Edit Air Conditioner name” dialog appears. Use this to change the name.

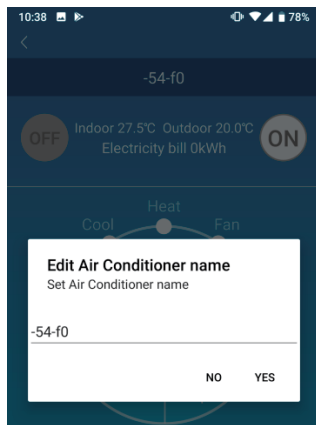

Figure 3-21

Enter a new air conditioner name and tap [YES].

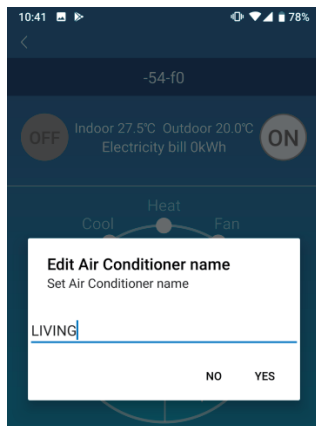

Figure 3-22

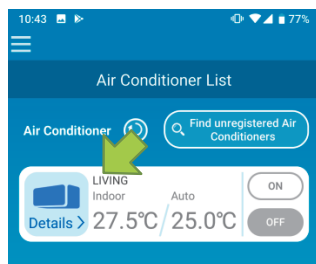

Figure 3-23

(4) Basic usage

- Starting / Stopping air conditioner operation

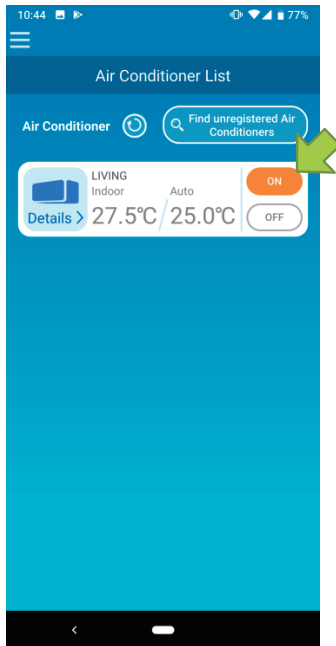

Figure 4-1

To start or stop the operation, tap the [ON] / [OFF] button of the air conditioner that you want to operate on the “Air Conditioner List” screen.

When the button color changes, switching is complete. (Grayed out when off)

To update to the latest information, tap  .

Note

- When operating an air conditioner from an external location, it may take up to one minute to complete the air conditioner operation.

- Switching operation mode

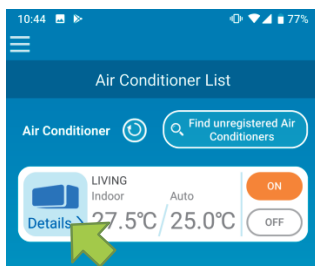

Figure 4-2

Tap an air conditioner that you want to switch the operation mode on the “Air Conditioner List” screen.



Figure 4-3

To change the “Operation mode”, tap each mode from “Auto” to “Dry”.

appears when the air conditioner is in clean mode. To cancel clean mode, tap .

appears when the weekly timer is set by this application.

appears when the application is used at home where the air conditioner is set and connected to the application.

• Changing temperature

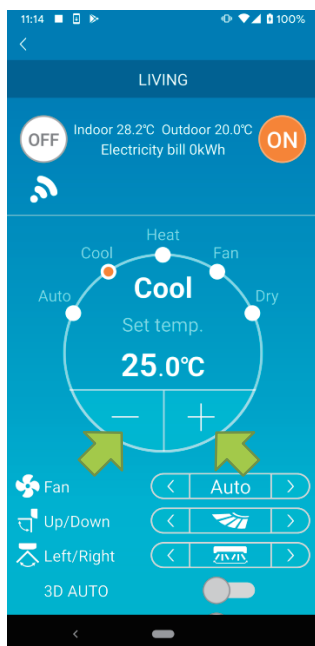
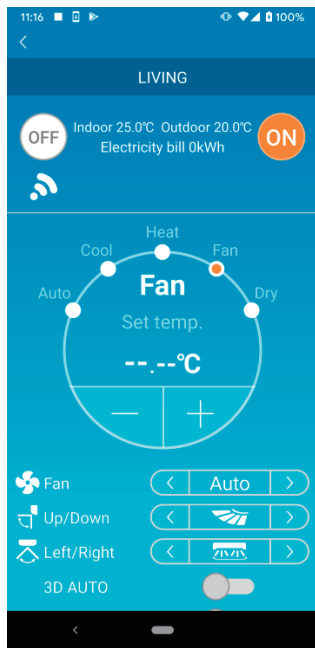

Figure 4-4

To set a desired temperature, tap / . The current set temperature appears in the circle.



When the operation mode is Fan, Set temp. shows "-".

Figure 4-5

- Changing fan speed and air flow direction



Tap < / > to change settings.

Figure 4-6

• Switching Vacant Property Mode

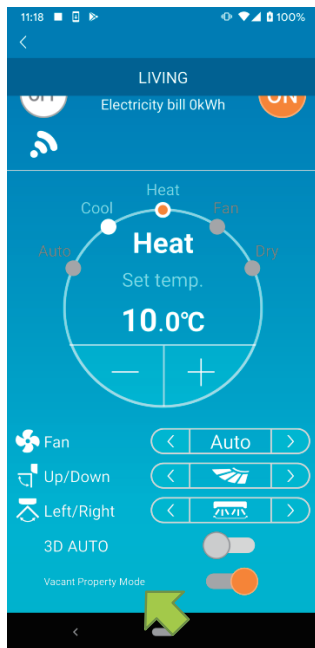

Figure 4-7

When Vacant Property Mode is ON, operation mode and Set temp. can be set as follows.

- Cool : Set temp. 31°C to 33°C (at 1°C intervals)
- Heat: Set temp. 10°C to 17°C (at 1°C intervals)

Only "Cool" or "Heat" can be set as an operation mode.

(5) Using Favourites

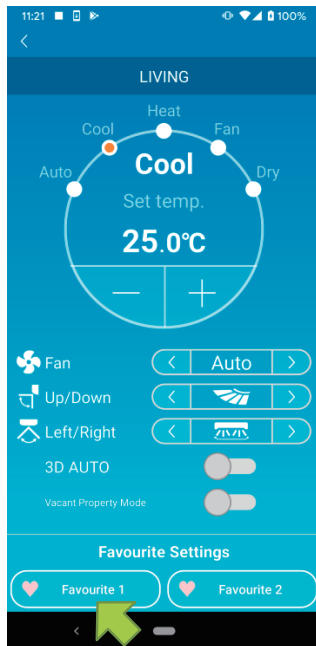



Figure 5-1

Register your desired settings of “Set temp”, “Operation mode”, “Fan”, “Up / Down” and “Left / Right” with Favourite. Tapping the [Favourite] button changes the current settings to the registered settings.

On the air conditioner details screen, press and hold down (1 sec) the [Favourite 1] or [Favourite 2] button. The “Favourite” screen appears.



Figure 5-2

Change each item to your favourite setting, and tap  on the top right to add it to Favourites.

Press  in the upper left of the screen to return to the operation screen.

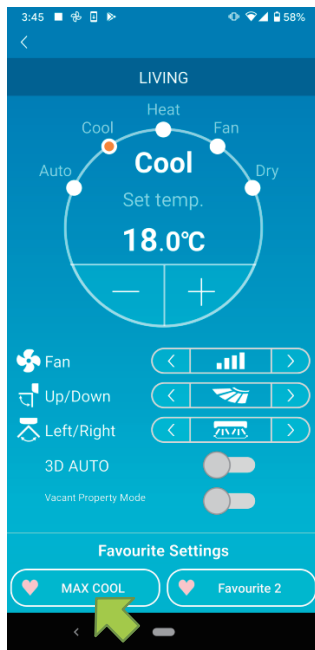

When you tap the [Favourite 1] or [Favourite 2] button, the current settings are changed to the favourite settings you tapped.

Figure 5-3

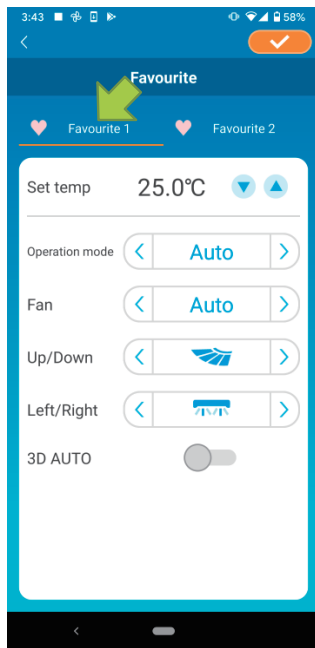

Figure 5-4

To change the name of the "Favourite" button, press and hold down the "Favourite" button for approximately 1 second. "Edit Favourite name" dialog appears to change the name.

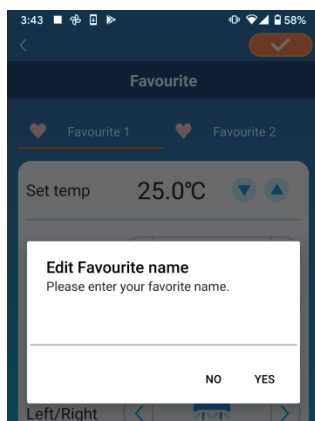

Figure 5-5

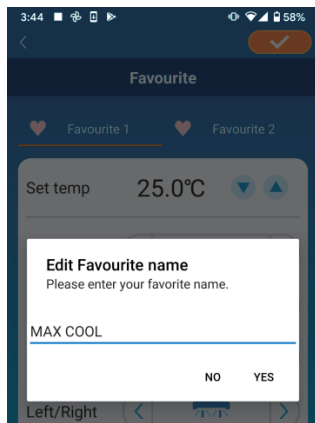

Figure 5-6

Enter the new favourite name and tap [YES].

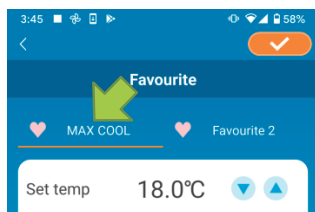

Figure 5-7

(6) Using Options

You can make various option settings such as alerts and LED lighting, and check the number of accounts registered with an air conditioner.

Home restricted mode : Only “Home Leave Mode”, “Cooling specific” and “LED ON” are operable.

Demo mode : Options are not operable.

You can switch to remote operation mode using "Changing Application Settings" in the main menu.

→ To [“Changing Application Settings”](#)

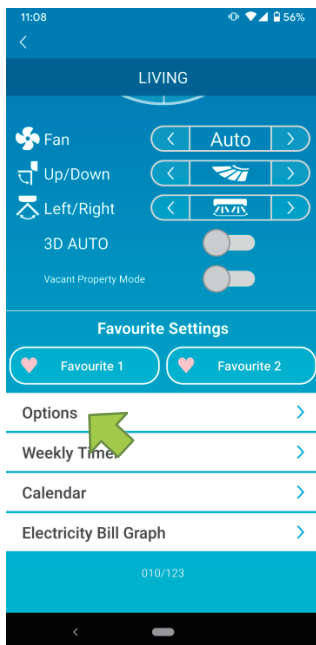

Tap [Options] on the lower part of the air conditioner details screen. The “Options” screen appears.

Figure 6-1

Only "LED ON" is ON by default.

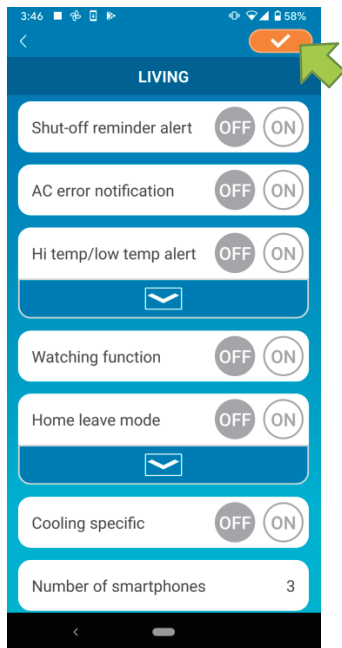



Figure 6-2

Switch between [ON] and [OFF], and tap  on the top right of the screen to save the settings you changed.

Note

- Shut-off reminder alert, AC error notification, Hi temp/low temp alert, Watching function can be used with "Remote operation mode".

• Shut-off reminder alert

If you are more than 1 km away from the air conditioner you are driving, you can receive a push notification to the smartphone application.

- To receive alerts, tap [ON].

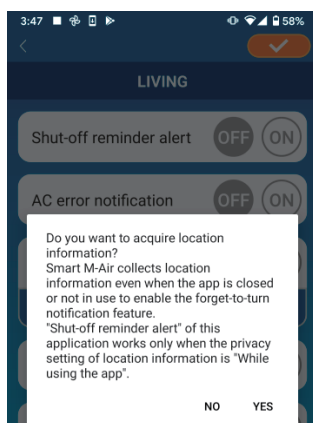

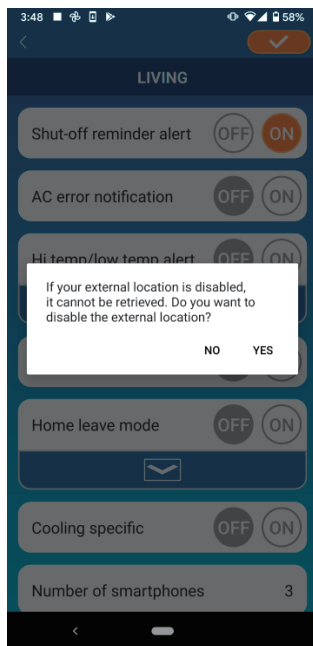

Figure 6-3

When the pop-up message appears, tap [YES] and then tap  on the top right.

- To not to receive alerts, tap [OFF].



When the pop-up message “If your external location is disabled, it cannot be retrieved. Do you want to disable the external location?” appears, tap [YES] and then tap  on the top right.

Figure 6-4



Note

- Acquisition of location information is performed by using the location of your smartphone as the location of the air conditioner. Perform location information acquisition near your air conditioner.

- AC error notification (Air conditioner error notification)



If any abnormality is detected in your air conditioner, an e-mail is sent to the registered e-mail address.

→ To “[When an abnormality notification appears in the air conditioner list](#)”

- To receive notifications, tap [ON] and then tap  on the top right.
- To not to receive notifications, tap [OFF] and then tap  on the top right.

- Hi temp/low temp alert

When the air conditioner reaches the specified high/low temperature condition, a push notification is sent to the smartphone application.

- To receive alerts, tap [ON] and enter the high and low temperatures and then tap  on the top right.
- To display the high and low temperatures input area, tap . To hide it, tap .

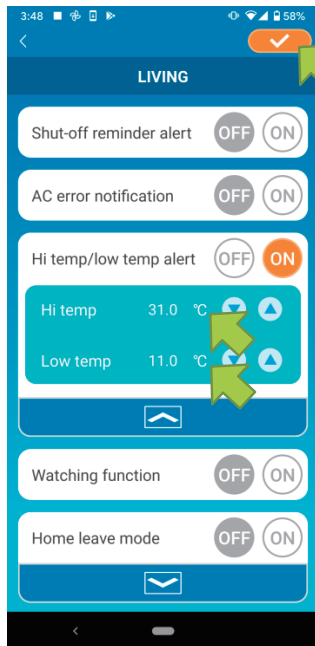

Figure 6-5

Note

- When the room temperature is higher / lower than the temperature specified here, alerts are sent. If you set the high temperature at 31°C, an alert is sent when the room temperature exceeds 31°C. No alert is sent at 31°C.
- Setting only either of high or low temperature receives alerts only for high or low temperature.



- To not to receive alerts, tap [OFF] and then tap  on the top right.

- Watching function

When the air conditioner is controlled other than your smartphone, an e-mail is sent to the registered e-mail address.

Note

- The notification also applies to the operation with the timer of the air conditioner itself and the end of internal clean operation.
-

- To receive alerts, tap [ON] and then tap  on the top right.
- To not to receive alerts, tap [OFF] and then tap  on the top right.

- Home leave mode

When the room temperature is lower than a setting temperature, heating is turned on automatically.

When the room temperature is higher than a setting temperature, cooling is turned on automatically.

- To use “Home leave mode”, tap [ON].

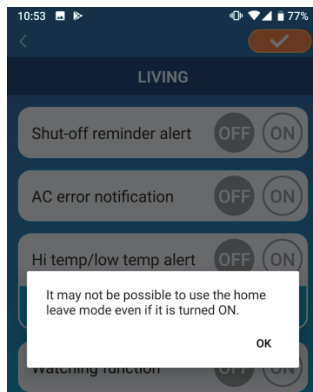





Figure 6-6

When the pop-up message “It may not be Possible to use the Home leave mode even if it is turned ON.” appears, tap [OK] and then tap  on the top right.

Note

- There is no "Home leave mode" depending on the air conditioner connected. In this case, "ON" has no effect.
-

- To not to use “Home leave mode”, tap [OFF] and then tap  on the top right.

- To change the setting of home leave mode, tap . To hide them, tap . The following settings can be changed.

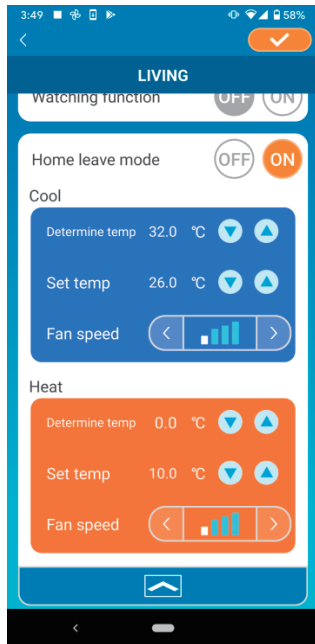

Figure 6-7

- **Determine temp** : Set the preferred outside temperature to start the operation of the air conditioner in cooling/heating mode.

Allowable setting range in cooling :

26°C to 35°C (at 3°C intervals)

Allowable setting range in heating :

0°C to 15°C (at 5°C intervals)

- **Set temp** : Set the preferred indoor temperature to operate in cooling/heating mode.

Allowable setting range in cooling :

26°C to 33°C (at 1°C intervals)

Allowable setting range in heating :

10°C to 18°C (at 1°C intervals)

- **Fan speed** : Set the fan speed in cooling/heating mode.

[example]

Cooling → When you input the determine temp. as 32°C, set temp. as 26°C and the fan speed at the slowest, the air conditioner will start operating at 26°C with the slowest fan speed when the outside temperature reaches to 32°C.

- Cooling specific

If you set it as an air conditioner for cooling only, you won't be able to use the heating in the smartphone application.

- To use “Cooling specific”, tap [ON] and then tap  on the top right.

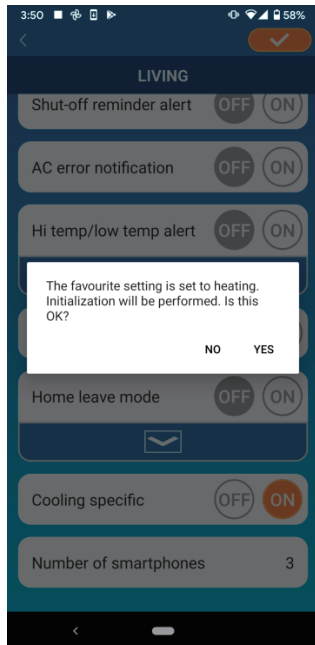

- When “ON” is set or “Heat” is set to favourites, the pop-up message asking whether to initialize favourites appears.



If you tap [YES] on the pop-up message, the “Cooling specific” setting is turned “ON” to initialize the favourite with heating set.

Figure 6-8

- To not to use “Cooling specific”, tap [OFF] and then tap  on the top right.

- LED ON

Lights up the LED of the wireless LAN interface.

- To use LED lighting, tap [ON] and then tap  on the top right.
- To not to use LED lighting, tap [OFF] and then tap  on the top right.

- Number of smartphones

Displays the number of smartphones registered with the air conditioner.

(7) Setting Weekly Timer

Makes the timer setting for every day of the week.

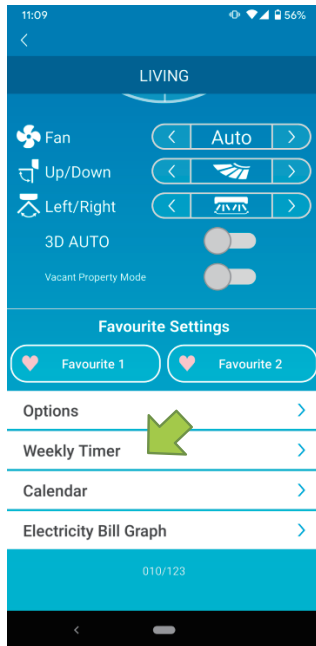

Tap [Weekly Timer] on the lower part of the air conditioner details screen.

The “Weekly Timer” screen appears.

Figure 7-1

Tap  on the top right of the screen to save the settings you changed.



Tap the day of the week you want to set to display the timer list for that day of the week.

You can set up to six timers for each day of the week, but you cannot set the same time for the same day.

Figure 7-2

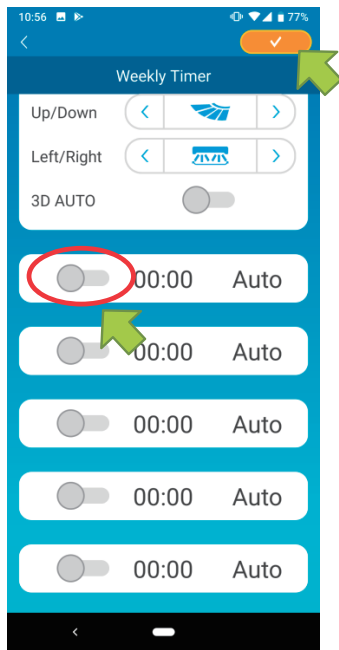

Figure 7-3

A disabled timer shows the time and operation mode only.

Tap the switch at  to enable and edit.

Edit each item and tap  on the top right to set the timer on the target day.



Figure 7-4

When at least one timer setting is ON, the timer icon appears on the air conditioner detail screen.

The timer you set here is applied to every week on that day.

To turn off the timer only on a certain day, or to apply the timer of another day, set individually from the “Calendar” screen.

(8) Setting Timer by Specifying Date via Calendar

When you set the weekly timer, the same timer is applied to the same day every week. To turn off the timer or set the timer of a different day on a certain day, set individually from the “Calendar” screen.

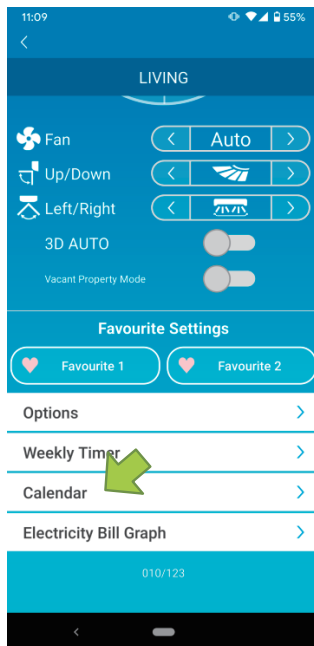

Figure 8-1

Tap [Calendar] on the lower part of the air conditioner details screen.

The [Calendar] screen appears.

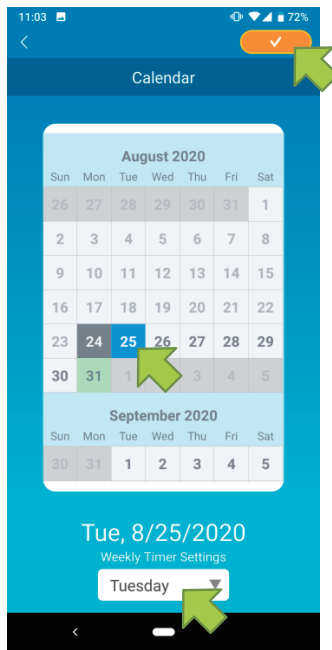



Figure 8-2

Tap the date of the calendar. Select the timer of the day of the week that you want to apply from “Weekly Timer Settings” and tap  on the top right of the screen.

If you select “OFF” from “Weekly Timer Settings”, the weekly timer is not applied.

When the timer of a different day of the week is applied or the timer is turned off, the date appears in green.

- Clear the timer set from the calendar

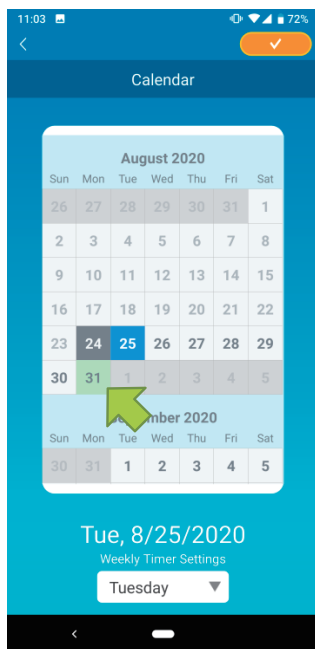

Figure 8-3

Tap the date whose timer you want to clear.

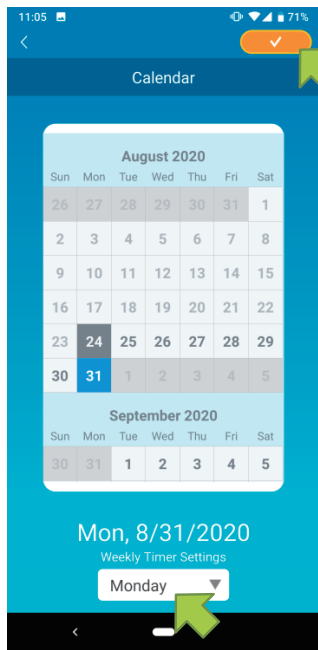



Figure 8-4

From “Weekly Timer Settings”, select the same day of the week as the date to clear and tap .

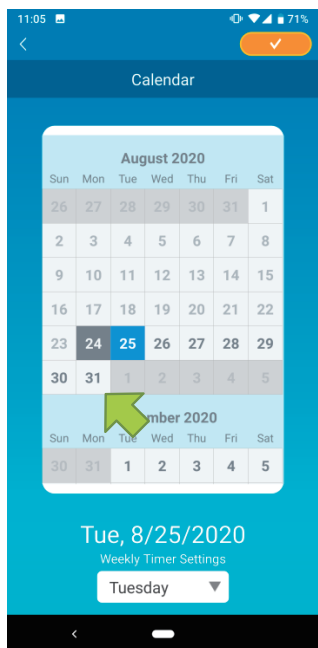

Figure 8-5

When cleared, the background of the date is displayed in white.

(9) Displaying Electricity Bill Graph

Displays an electricity bill by month on a graph. You can also set the electricity unit cost.

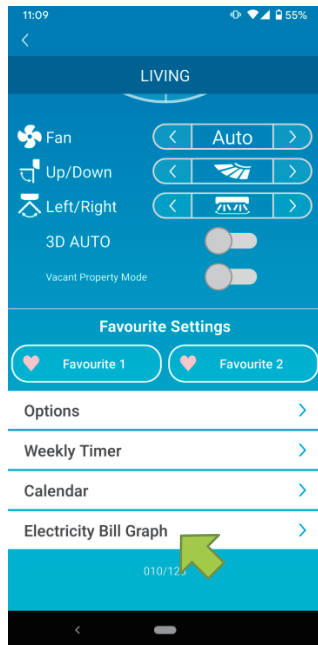

Figure 9-1

Note

Depending on the type of air conditioner you connect, the function may be disabled.

Tap [Electricity Bill Graph] on the lower part of the air conditioner details screen.

The “Electricity Bill Graph” screen appears.

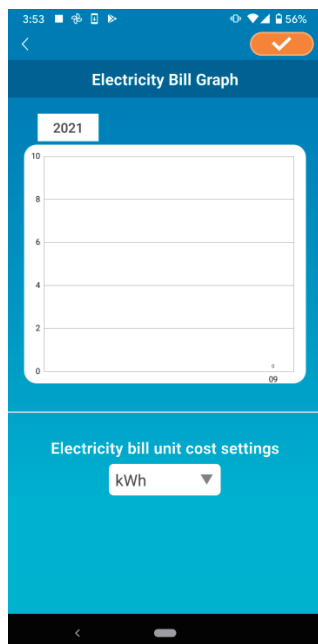

Figure 9-2

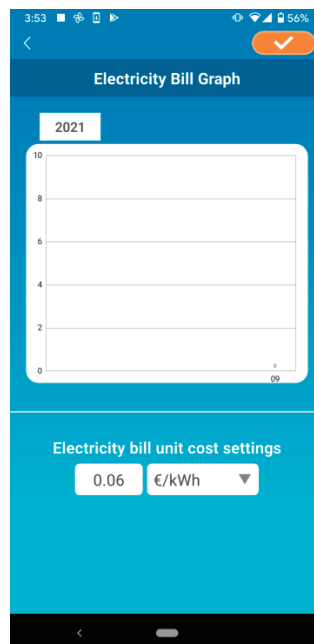



Figure 9-3

If you change the electricity bill unit cost settings, you can enter a unit price by changing the unit of measure.

After editing, tap  to save the setting.

(10) Updating Firmware

If the firmware of your wireless LAN interface is not up to date, an exclamation mark **!** appears on the “Air Conditioner List” screen.

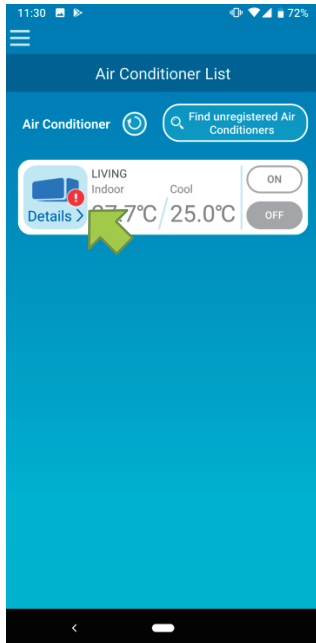

Figure 10-1

Tap [Details] to display the air conditioner details screen.

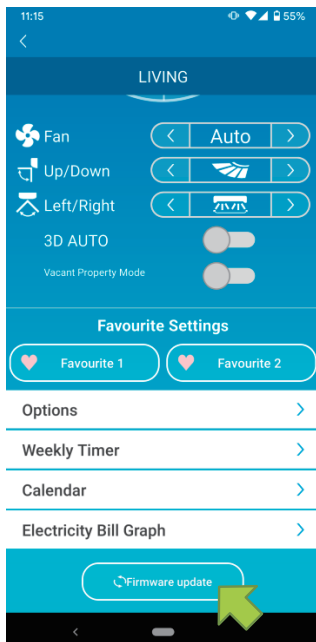

Figure 10-2

Tap the [Firmware update] button.

Note

- Perform the firmware update in the same wireless LAN area as the air conditioner.
- Please turn off the air conditioner in advance.
- If firmware update is disabled, the button is not enabled.

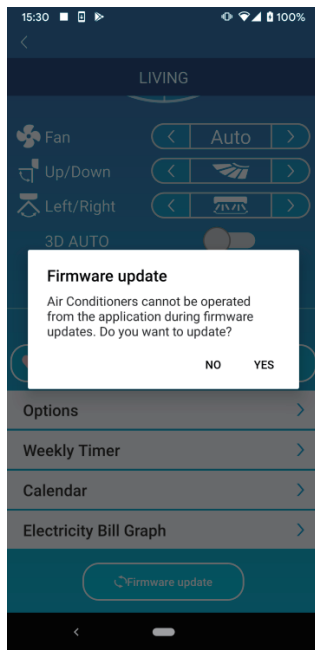

Figure 10-3

Tap [YES] to update the firmware to the latest one.

The firmware update takes 10 minutes (Max). The operation from the application is not accepted during that period.

If after 10 minutes (Max) the "Firmware update" button appears, retry the firmware update.

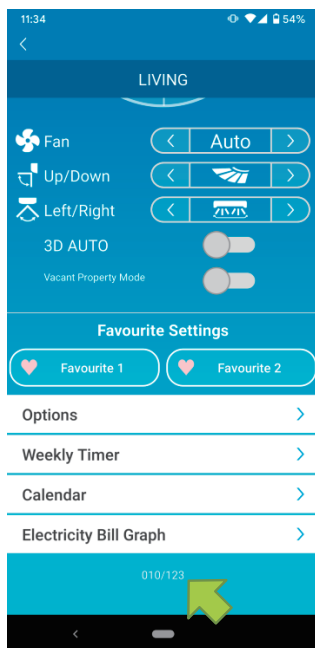

Figure 10-4

When the firmware becomes up to date, the firmware version appears instead of the [Firmware update] button.

(11) Main Menu

Tap the menu button (☰) that appears on the top left in the screen such as “Air Conditioner List”, to display the main menu.

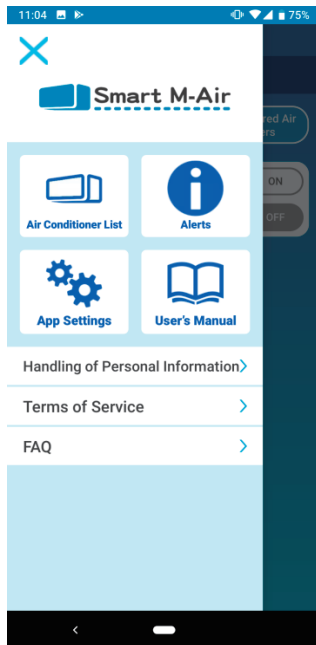
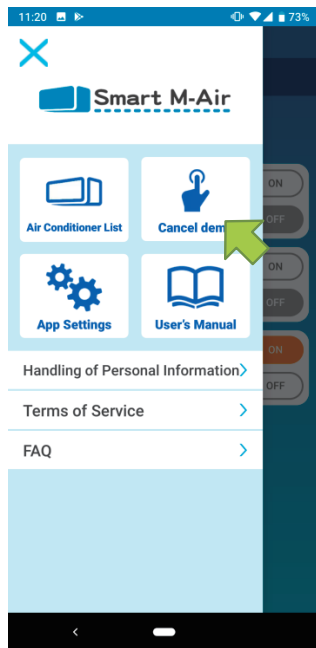

Figure 11-1

- Air Conditioner List : Operates or sets an Air conditioner.
- Alerts : Checks alerts.
- App Settings : Switches the operation mode or sets the password.
- User's Manual : Displays the user's manual.
- Handling of Personal Information : Displays the handling of personal information.
- Terms of Service : Displays the terms of service.
- FAQ : Displays the FAQ.

- Canceling demo mode



In the demo mode
Cancel demo : Exits the demo mode.

Figure 11-2

(12) Checking Alerts

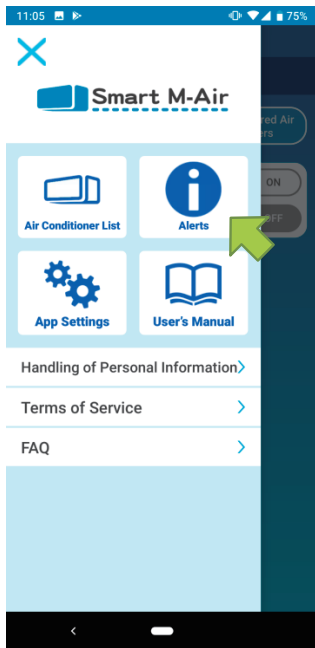

Figure 12-1

Open the main menu and tap [Alerts].

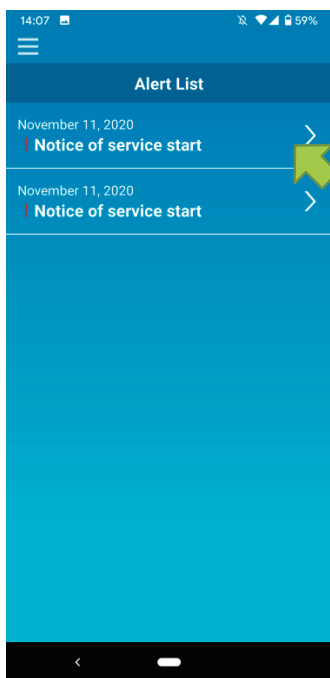

Figure 12-2

A list of alerts appears.

Tap each alert to display the alert details screen and check it.

! appears to the alert that is not checked in the alert details screen.

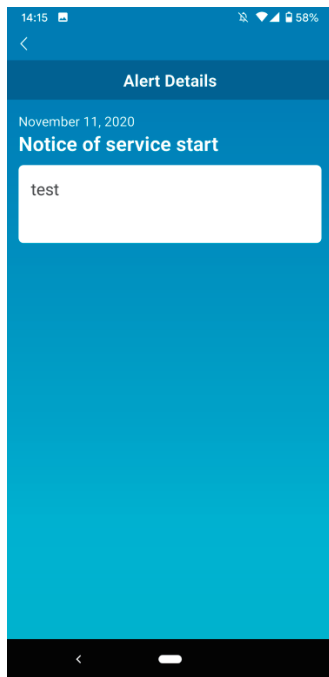

Figure 12-3

(13) Changing Application Settings

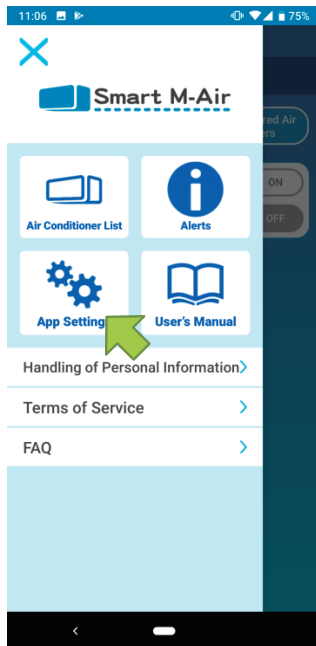

Figure 13-1

Open the main menu and tap [App Settings].

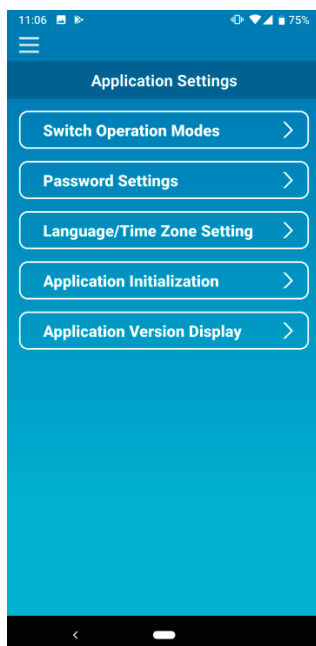

Figure 13-2

The “Application Settings” screen appears.

- **Switch Operation Modes:** Switches between the remote operation mode and home restricted mode.
 - To [“Switch Operation Modes”](#)
- **Password Settings:** Sets a password.
 - To [“Reset Password”](#)
- **Language/Time Zone Settings:** Sets a language to use in the smartphone application and a time zone for an air conditioner.
 - To [“Language/Time Zone Settings”](#)
- **Application Initialization:** Initializes the smartphone application.
 - To [“Application Initialization”](#)
- **Application Version Display:** Displays the version of your smartphone application.
 - To [“Application Version Display”](#)

Note

- In "Home restricted mode", you cannot operate "Password Settings". In "Try a Demo", only "Language/Time Zone Settings" and "Application Version Display" can be operated. Functions that cannot be operated are displayed in gray, and nothing is displayed even if you tap them.
-

- **Switch Operation Modes**

You can see the current operation mode.

To switch the operation mode, select the desired mode and tap .

- **Switching to "Remote operation mode"**

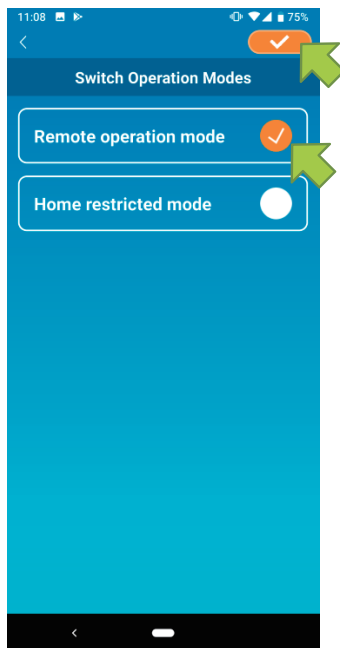

Tap [Remote operation mode] → Tap  on the top right to switch the mode.

Figure 13-3

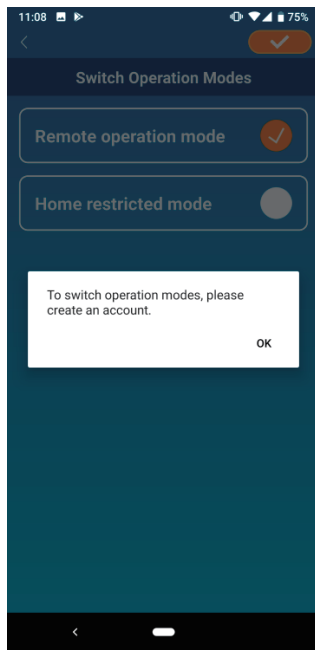

Figure 13-4

When the account creation pop-up message appears, tap [OK], agree with the handling of personal information, and create an account.

→ To [“Creating user account”](#)

• Switching to “Home restricted mode”

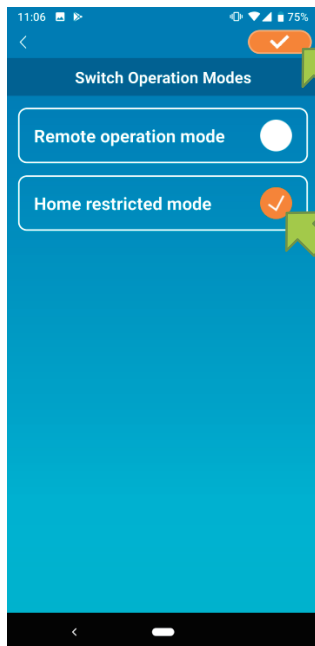



Figure 13-5

Tap [Home restricted mode] → Tap  on the top right to switch the mode.

Note

- Note that if you switch the mode to “Home restricted mode”, the account information used in “Remote operation mode” is deleted.

The popup for remote control disabled and the popup for deleting server data will appear, so tap [YES].

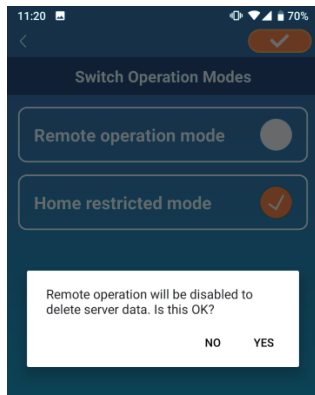

Figure 13-6

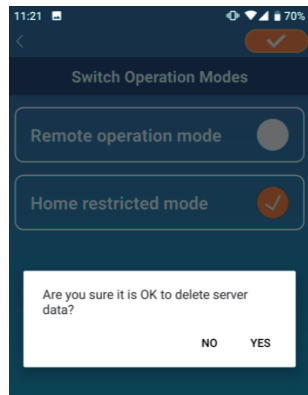

Figure 13-7

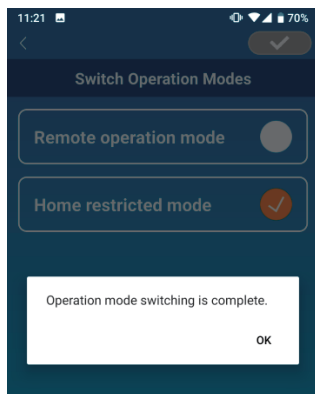

Figure 13-8

When the operation mode switching completion pop-up message appears, tap [OK].

• Reset Password

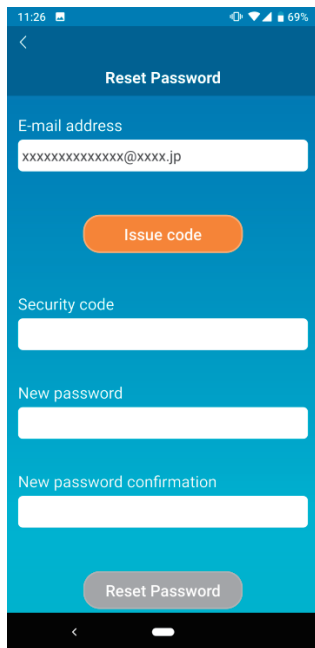



Figure 13-9

Enter the registered e-mail address and tap the [Issue code] button.

Note

- After tapping the [Issue code] button, keep this screen displayed until the password resetting is completed. If you tap  and return to the previous screen, these operations are canceled.

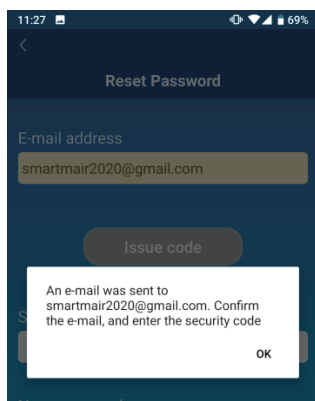

Figure 13-10

When the e-mail sending pop-up message appears, tap [OK].

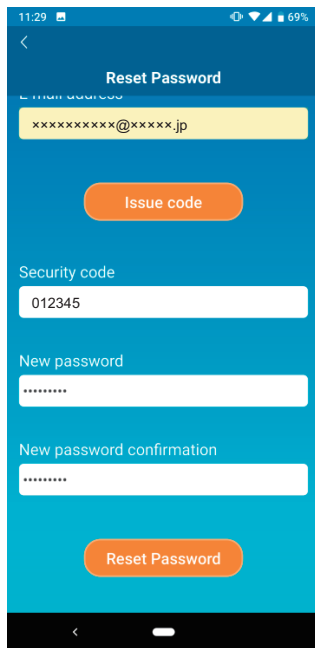

Figure 13-11

An e-mail with a security code will be sent to the e-mail address you entered. Enter “Security code” and “New password” and tap [Reset Password] to update your password.

Note

- A password must be between 8 to 16 characters including at least one alphabetic character and one numeric character.
-

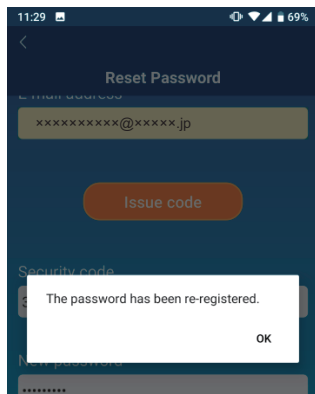
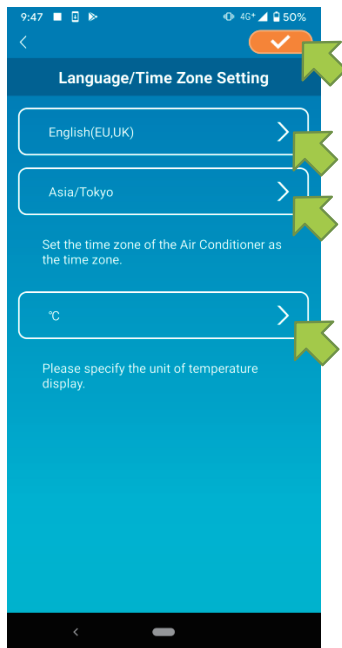

Figure 13-12

- Language/Time Zone Settings



The “Language/Time Zone Settings” screen appears.

Select a language to use in the application.

Select a time zone. Select the time zone in which the air conditioner to operate via the application exists.

Choose the unit of temperature.

Finally, tap  on the top right to complete the setting.

Figure 13-13

- Application Initialization

Initializes the smartphone application.

Note

- Note that if you initialize the application in “Remote operation mode”, the information of the account logged in is deleted.
-



Tap [Initialize the application].

Figure 13-14

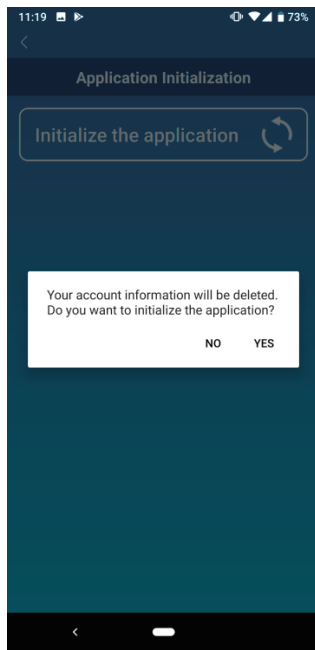

Figure 13-15

When the pop-up message “Your account information will be deleted. Do you want to initialize the application?” appears, tap [YES].

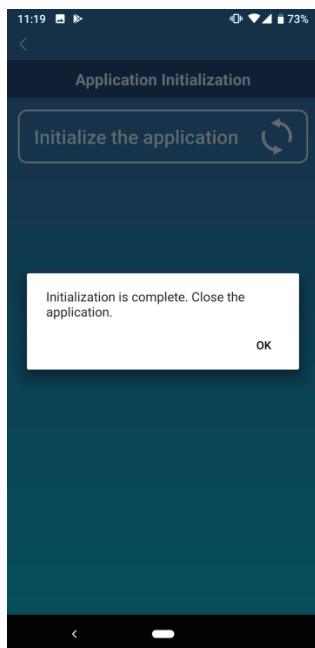

Figure 13-16

When the pop-up message "Initialization is complete. Close the application." appears, tap [OK] to close the application.

- Application Version Display

Displays the version of your smartphone application.

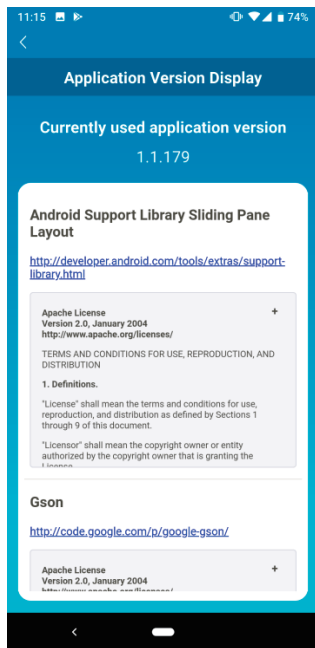
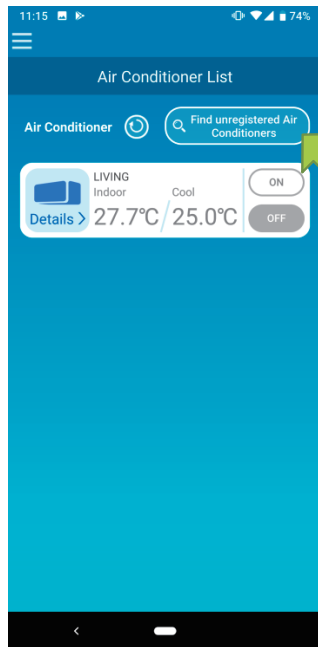

Figure 13-17

(14) Troubleshooting

- When the air conditioner that you want to register does not appear in the air conditioner list screen



Tap the [Find unregistered Air Conditioners] Button to search unregistered air conditioners and update the "Air Conditioner List" screen.

Figure 14-1

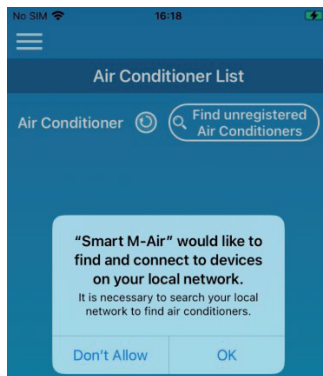

When asked for "search your local network" on iOS, tap the "OK" button.

If you accidentally tap the "Don't Allow" button, change the Smart M-Air's "local network" in the iOS app permission settings to "ON", then tap the "Find unregistered Air Conditioner" button again.

Figure 14-2

- How to delete a registered air conditioner

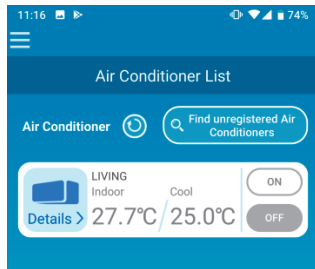

Figure 14-3

To delete a registered air conditioner, press and hold down (2 seconds) the icon of the target air conditioner.

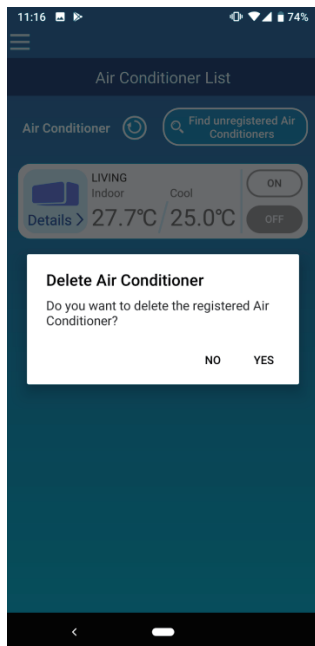

Figure 14-4

When the deleting air conditioner pop-up Message appears, tap [YES].

- When an abnormality notification appears in the air conditioner list

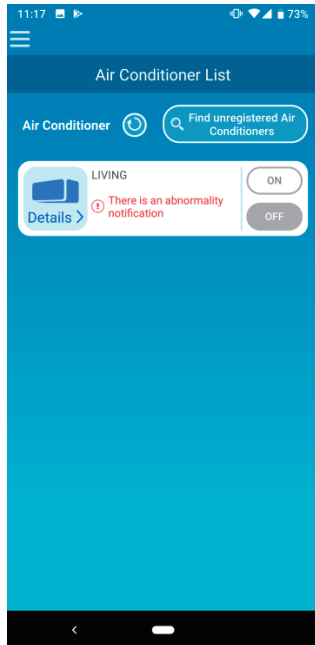

Figure 14-5

When an abnormality notification appears, air conditioner abnormality has been detected. Contact your dealer.

When “AC error notification” of the option settings is enabled, an e-mail is sent to the registered e-mail address.

- When you forget your password and cannot log in

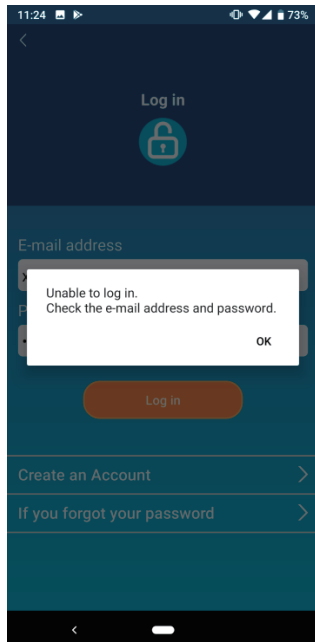

Figure 14-6

If you forgot your password and failed to log in, tap [OK] on the pop-up message, tap [If you forgot your password] to display the “Reset Password” screen, and set a new password.

→ To [“Reset Password”](#)

- When operation is performed by another account

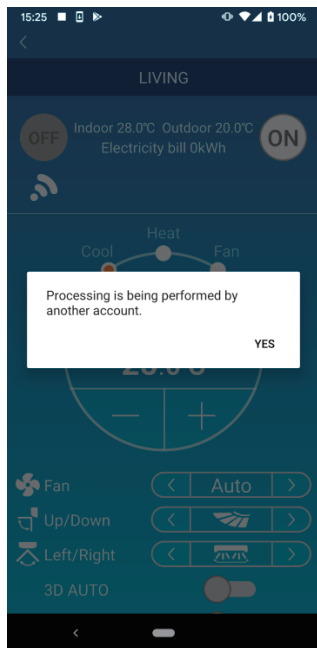

Figure 14-7

The message shows in the following cases:

- When the application is operated from other smartphones at the same time
- When the air conditioner is changing its operation status by its set control

The equipment is not malfunctioning, so please try again after a while.

(Approximately 1 minute)

- When "Shut-off reminder alert" does not turn on (For Android OS)

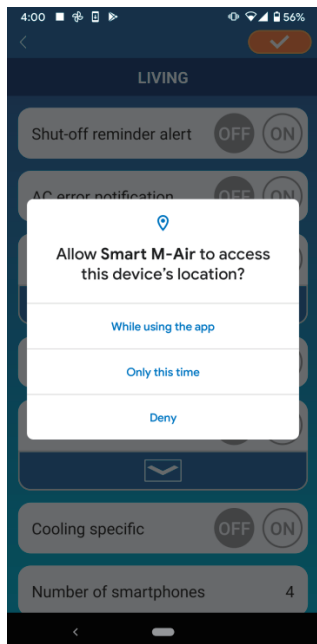

Figure 14-8

You must select "While using the app" when there is a request to allow access to your device information for this application.

If you accidentally tap other buttons such as "Only this time" or "Deny", you can change it to "While using the app" in Android OS Setting Screen.

14. OPTION PARTS



(1) Wired remote control

(a) Model RC-EX3A

PJZ012A171 

1) Safety precautions

- Please read this manual carefully before starting installation work to install the unit properly. Every one of the followings is important information to be observed strictly.

 WARNING	Failure to follow these instructions properly may result in serious consequences such as death, severe injury, etc.
 CAUTION	Failure to follow these instructions properly may cause injury or property damage.

It could have serious consequences depending on the circumstances.

- The following pictograms are used in the text.

	Never do.		Always follow the instructions given.
---	-----------	---	---------------------------------------

- Keep this manual at a safe place where you can consult with whenever necessary. Show this manual to installers when moving or repairing the unit. When the ownership of the unit is transferred, this manual should be given to a new owner.

WARNING



Consult your dealer or a professional contractor to install the unit.

Improper installation made on your own may cause electric shocks, fire or dropping of the unit.



Installation work should be performed properly according to this installation manual.

Improper installation work may result in electric shocks, fire or break-down.



Be sure to use accessories and specified parts for installation work.

Use of unspecified parts may result in drop, fire or electric shocks.



Install the unit properly to a place with sufficient strength to hold the weight.

If the place is not strong enough, the unit may drop and cause injury.



Be sure to have the electrical wiring work done by qualified electrical installer, and use exclusive circuit.

Power source with insufficient and improper work can cause electric shock and fire.



Shut OFF the main power source before starting electrical work.

Otherwise, it could result in electric shocks, break-down or malfunction.



Do not modify the unit.

It could cause electric shocks, fire, or break-down.



Be sure to turn OFF the power circuit breaker before repairing/ inspecting the unit.

Repairing/inspecting the unit with the power circuit breaker turned ON could cause electric shocks or injury.

⚠ WARNING**Do not install the unit in appropriate environment or where inflammable gas could generate, flow in, accumulate or leak.**

If the unit is used at places where air contains dense oil mist, steam, organic solvent vapor, corrosive gas (ammonium, sulfuric compound, acid, etc) or where acidic or alkaline solution, special spray, etc. are used, it could cause electric shocks, break-down, smoke or fire as a result of significant deterioration of its performance or corrosion.

Do not install the unit where water vapor is generated excessively or condensation occurs.

It could cause electric shocks, fire, or break-down.

Do not use the unit in a place where it gets wet, such as laundry room.

It could cause electric shocks, fire, or break-down.

Do not operate the unit with wet hands.

It could cause electric shocks.

Do not wash the unit with water.

It could cause electric shocks, fire, or break-down.

Use the specified cables for wiring, and connect them securely with care to protect electronic parts from external forces.

Improper connections or fixing could cause heat generation, fire, etc.

Seal the inlet hole for remote control cable with putty.

If dew, water, insect, etc. enters through the hole, it could cause electric shocks, fire or break-down.

If dew or water enters the unit, it may cause screen display anomalies.

When installing the unit at a hospital, telecommunication facility, etc., take measures to suppress electric noises.

It could cause malfunction or break-down due to hazardous effects on the inverter, private power generator, high frequency medical equipment, radio communication equipment, etc.

The influences transmitted from the remote control to medical or communication equipment could disrupt medical activities, video broadcasting or cause noise interference.

Do not leave the remote control with its upper case removed.

If dew, water, insect, etc. enters through the hole, it could cause electric shocks, fire or break-down.

 CAUTION

Do not install the remote control at following places.

- (1) It could cause break-down or deformation of remote control.
- Where it is exposed to direct sunlight
 - Where the ambient temperature becomes 0 °C or below, or 40 °C or above
 - Where the surface is not flat
 - Where the strength of installation area is insufficient
- (2) Moisture may be attached to internal parts of the remote control, resulting in a display failure.
- Place with high humidity where condensation occurs on the remote control
 - Where the remote control gets wet
- (3) Accurate room temperature may not be detected using the temperature sensor of the remote control.
- Where the average room temperature cannot be detected
 - Place near the equipment to generate heat
 - Place affected by outside air in opening/closing the door
 - Place exposed to direct sunlight or wind from air-conditioner
 - Where the difference between wall and room temperature is large



To connect to a personal computer via USB, use the dedicated software.**Do not connect other USB devices and the remote control at the same time.**

It could cause malfunction or break-down of the remote control/personal computer.

2) Accessories & prepare on site

Following parts are provided.

Accessories	R/C main unit, wood screw (φ 3.5 x 16) 2 pcs., Quick reference
-------------	--

Following parts are arranged at site. Prepare them according to the respective installation procedures.

Item name	Q'ty	Remark
Switch box For 1 piece or 2 pieces (JIS C 8340 or equivalent)	1	These are not required when installing directly on a wall.
Thin wall steel pipe for electric appliance directly on a wall. (JIS C 8305 or equivalent)	As required	
Lock nut, bushing (JIS C 8330 or equivalent)	As required	
Lacing (JIS C 8425 or equivalent)	As required	Necessary to run R/C cable on the wall.
Putty	Suitably	For sealing gaps
Molly anchor	As required	
R/C cable (0.3 mm ² x 2 pcs.)	As required	See right table when longer than 100m

When the cable length is longer than 100 m, the max size for wires used in the R/C case is 0.5 mm². Connect them to wires of larger size near the outside of R/C. When wires are connected, take measures to prevent water, etc. from entering inside.

≤ 200 m	0.5 mm ² x 2 cores
≤ 300m	0.75 mm ² x 2 cores
≤ 400m	1.25 mm ² x 2 cores
≤ 600m	2.0 mm ² x 2 cores

3) Installation place

Secure the installation space shown in the figure.

For the installation method, “embedding wiring” or “exposing wiring” can be selected.

For the wiring direction, “Backward”, “Upper center” or “Upper left” can be selected.

Determine the installation place in consideration of the installation method and wiring direction.

Installation space

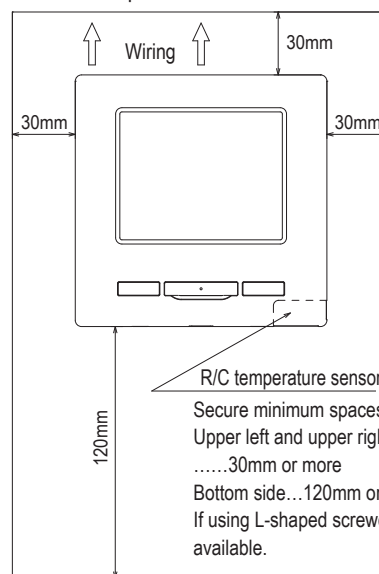

Secure minimum spaces for disassembling the case.
 Upper left and upper right sides
30mm or more
 Bottom side...120mm or more
 If using L-shaped screwdriver, 50mm or more is available.

4) Installation procedure

Perform installation and wiring work for the remote control according to the following procedure.

Dimensions (Viewed from front)

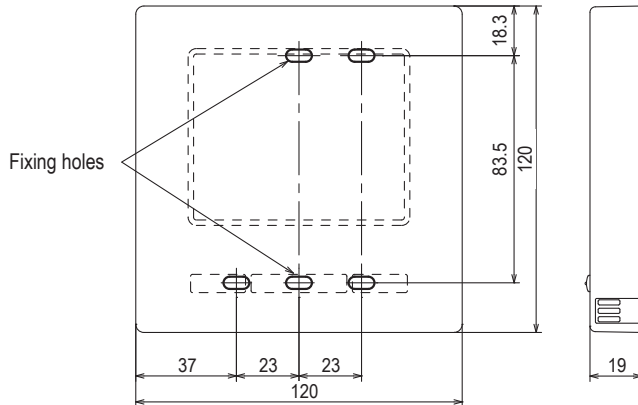

To disassemble the R/C case into the upper and lower pieces after assembling them once

- Insert the tip of flat head screwdriver or the like in the recess at the lower part of R/C and twist it lightly to remove. It is recommended that the tip of the screwdriver be wrapped with tape to avoid damaging the case.

Take care to protect the removed upper case from moisture or dust.

In case of embedding wiring

(When the wiring is retrieved "Backward")

- ① Embed the switch box and the R/C wires beforehand.
Seal the inlet hole for the R/C wiring with putty

PCB side (Viewed from rear)

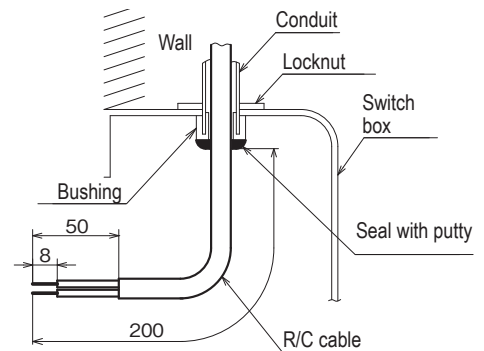
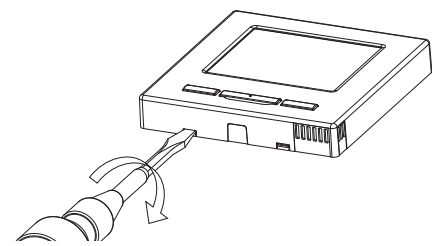
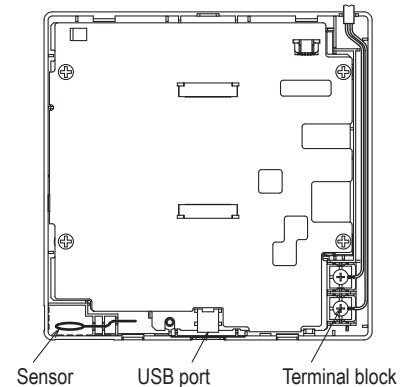

- ② When wires are passed through the bottom case, fix the bottom case at 2 places on the switch box.

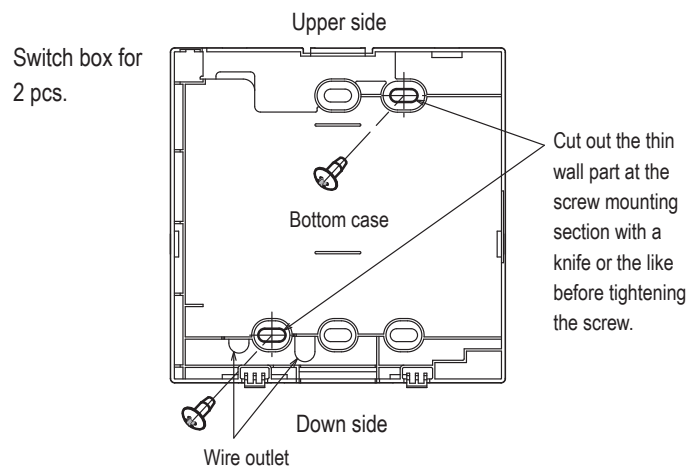
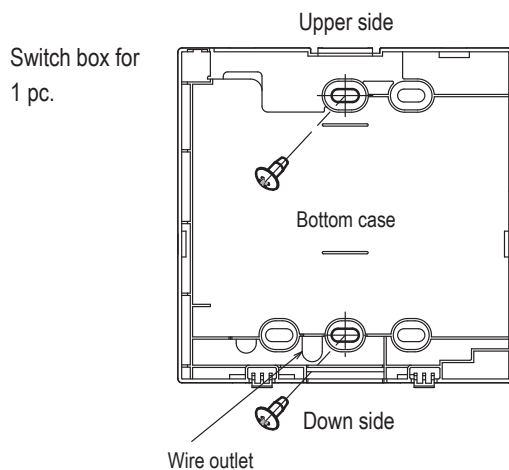

- ③ Connect wires from X and Y terminals of R/C to X and Y terminals of indoor unit. R/C wires (X, Y) have no polarity. Fix wires such that the wires will run around the terminal screws on the top case of R/C.
- ④ Install the upper case with care not to pinch wires of R/C.

Cautions for wire connection

Use wires of no larger than 0.5 mm² for wiring running through the remote control case. Take care not to pinch the sheath.

Tighten by hand (0.7 N·m or less) the wire connection. If the wire is connected using an electric driver, it may cause failure or deformation.

In case of exposing wiring

(When the wiring is taken out from the “upper center” or “upper left” of R/C)

- ① Cut out the thin wall sections on the cases for the size of wire.

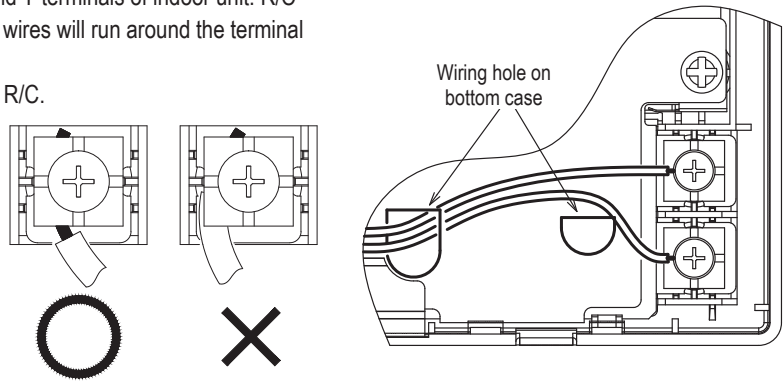

When taking the wiring out from the upper center, open a hole before separating the upper and bottom cases. This will reduce risk of damaging the PCB and facilitate subsequent work.
 When taking the wiring out from the upper left, take care not to damage the PCB and not to leave any chips of cut thin wall inside.

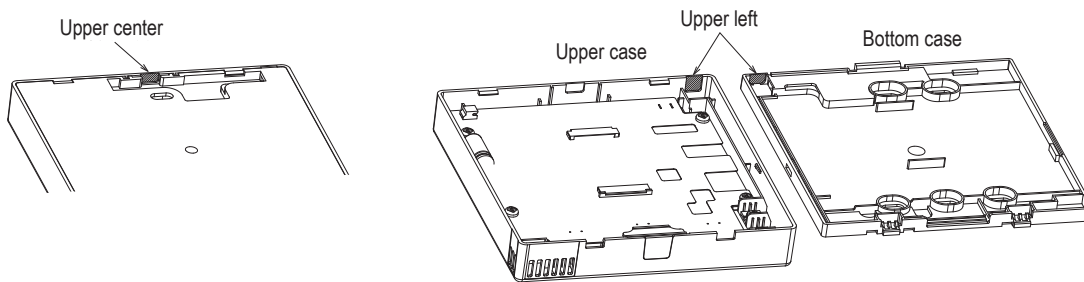

- ② Fix the bottom R/C case on a flat surface with two wood screws.
- ③ In case of the upper center, pass the wiring behind the bottom case. (Hatched section)
- ④ Connect wires from X and Y terminals of R/C to X and Y terminals of indoor unit. R/C wires (X, Y) have no polarity. Fix wires such that the wires will run around the terminal screws on the top case of R/C.
- ⑤ Install the top case with care not to pinch wires of R/C.
- ⑥ Seal the area cut in ① with putty.

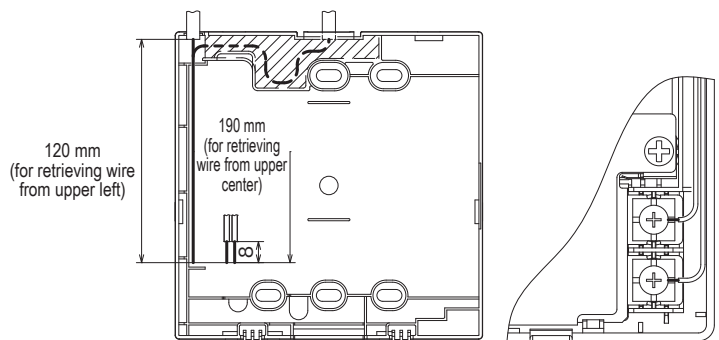

5) Main/Sub setting when more than one remote control are used

Up to two units of R/C can be used at the maximum for 1 indoor unit or 1 group.

One is main R/C and the other is sub R/C.

Operating range is different depending on the main or sub R/C.

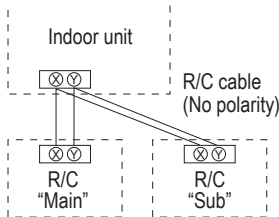

R/C operations		Main	Sub	
Run/Stop, Change set temp., Change flap direction, Auto swing, Change fan speed operations		○	○	
High power operation, Energy-saving operation		○	○	
Silent mode control		○	×	
Useful functions	Individual flap control	○	×	
	Anti draft setting	○	×	
	Timer	○	○	
	Favorite setting	○	○	
	Weekly timer	○	×	
	Home leave mode	○	×	
	External ventilation	○	○	
	Select the language	○	○	
	Silent mode control	○	×	
	Energy-saving setting	○	×	
Filter	Filter sign reset	○	○	
User setting	Initial settings		○	○
	Administrator settings	Permission/Prohibition setting	○	×
		Outdoor unit silent mode timer	○	×
		Setting temp. range	○	×
	Temp increment setting	○	×	
	Set temp. display	○	○	
	R/C display setting	○	○	
	Change administrator password	○	○	
F1/F2 function setting	○	○		

○ : operable × : not operable

R/C operations		Main	Sub		
Service setting	Installation settings	Installation date	○	×	
		Company information	○	○	
		Test run	○	×	
		Static pressure adjustment	○	×	
		Change auto-address	○	×	
		Address setting of main IU	○	×	
		IU back-up function	○	×	
		Motion sensor setting	○	×	
		R/C function settings	Main/Sub of R/C	○	○
			Return air temp.	○	×
			R/C sensor	○	×
	R/C sensor adjustment		○	×	
	Operation mode		○	×	
	°C / °F		○	×	
	Fan speed		○	×	
	External input		○	×	
	Upper/lower flap control		○	×	
	Left/right flap control		○	×	
	IU settings	Ventilation setting	○	×	
		Auto-restart	○	×	
		Auto temp. setting	○	×	
		Auto fan speed	○	×	
		Service & Maintenance	IU address	○	○
			Next service date	○	×
	Operation data		○	×	
	Error display		Error history	○	○
			Display/erase anomaly data	○	×
			Reset periodical check	○	○
	Saving IU settings		○	×	
	Special settings		Erase IU address	○	×
			CPU reset	○	○
			Restore of default setting	○	×
		Touch panel calibration	○	○	
	Indoor unit capacity display	○	×		

Advice: Connection to personal computer

It can be set from a personal computer via the USB port (mini-B). Connect after removing the cover for USB port of upper case. Replace the cover after use. Special software is necessary for the connection. For details, view the web site.

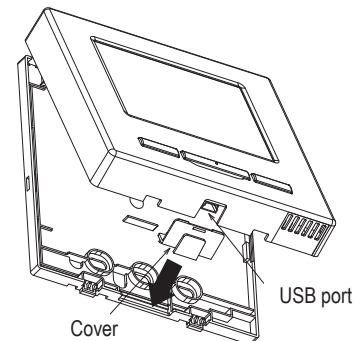

Advice: Initializing of password

Administrator password (for daily setting items) and service password (for installation, test run and maintenance) are used.

- The administrator password at factory default is "0000". This setting can be changed (Refer to User's Manual).

If the administrator password is forgotten, it can be initialized by holding down the [F1] and [F2] switches together for five seconds on the administrator password input screen.

- Service password is "9999", which cannot be changed. When the administrator password is input, the service password is also accepted.

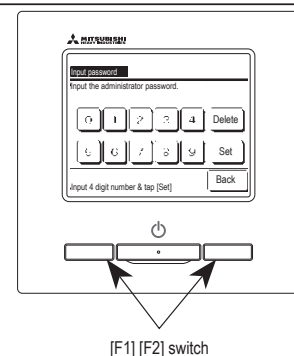



PJA012D730 

(b) Model RC-E5

Read together with indoor unit's installation manual.



⚠ WARNING

- Fasten the wiring to the terminal securely and hold the cable securely so as not to apply unexpected stress on the terminal.
Loose connection or hold will cause abnormal heat generation or fire. 
- Make sure the power source is turned off when electric wiring work.
Otherwise, electric shock, malfunction and improper running may occur. 

⚠ CAUTION

- Do not install the remote control at the following places in order to avoid malfunction.

(1) Places exposed to direct sunlight	(4) Hot surface or cold surface enough to generate condensation
(2) Places near heat devices	(5) Places exposed to oil mist or steam directly
(3) High humidity places	(6) Uneven surface

- Do not leave the remote control without the upper case.
In case the upper case needs to be detached, protect the remote control with a packaging box or bag in order to keep it away from water and dust. 

Accessories	Remote control, wood screw (ø3.5×16) 2 pieces
Prepare on site	Remote control cord (2 cores) the insulated thickness in 1mm or more. [In case of embedding cord] Electrical box, M4 screw (2 pieces) [In case of exposing cord] Cord clamp (if needed)

Installation procedure

- ① Open the cover of remote control, and remove the screw under the buttons without fail.
- ② Remove the upper case of remote control.
Insert a flat-blade screwdriver into the dented part of the upper part of the remote control, and wrench slightly.

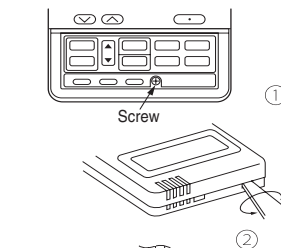

[In case of embedding cord]

- ③ Embed the electrical box and remote control cord beforehand.

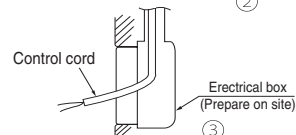

- ④ Prepare two M4 screws (recommended length is 12-16mm) on site, and install the lower case to electrical box. Choose either of the following two positions in fixing it with screws.

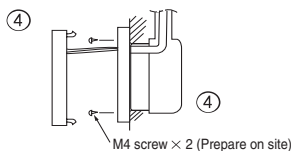
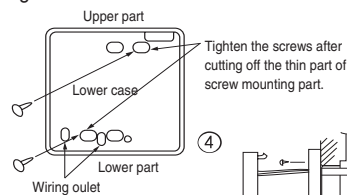
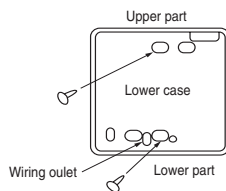

- ⑤ Connect the remote control cord to the terminal block.
Connect the terminal of remote control (X,Y) with the terminal of indoor unit (X,Y). (X and Y are no polarity)
- ⑥ Install the upper case as before so as not to catch up the remote control cord, and tighten with the screws.

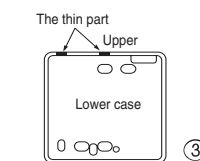

[In case of exposing cord]

- ③ You can pull out the remote control cord from left upper part or center upper part.
Cut off the upper thin part of remote control lower case with a nipper or knife, and grind burrs with a file etc.
- ④ Install the lower case to the flat wall with attached two wooden screws.

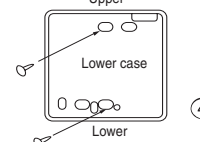

- ⑤ Connect the remote control cord to the terminal block.
 Connect the terminal of remote control (X,Y) with the terminal of indoor unit (X,Y).
 (X and Y are no polarity)
 Wiring route is as shown in the right diagram depending on the pulling out direction.

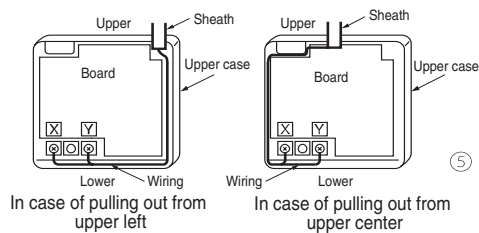

The wiring inside the remote control case should be within 0.3mm² (recommended) to 0.5mm².
 The sheath should be peeled off inside the remote control case.
 The peeling-off length of each wire is as below.

Pulling out from upper left	Pulling out from upper center
X wiring : 215mm	X wiring : 170mm
Y wiring : 195mm	Y wiring : 190mm

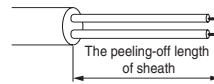

- ⑥ Install the upper case as before so as not to catch up the remote control cord, and tighten with the screws.
 ⑦ In case of exposing cord, fix the cord on the wall with cord clamp so as not to slack.

Installation and wiring of remote control

- ① Wiring of remote control should use 0.3mm² × 2 cores wires or cables. (on-site configuration)
 ② Maximum prolongation of remote control wiring is 600 m.
 If the prolongation is over 100m, change to the size below.
 But, wiring in the remote control case should be under 0.5mm². Change the wire size outside of the case according to wire connecting. Waterproof treatment is necessary at the wire connecting section. Be careful about contact failure.
- 100 - 200m.....0.5mm² × 2 cores
 Under 300m.....0.75mm² × 2 cores
 Under 400m.....1.25mm² × 2 cores
 Under 500m.....2.0mm² × 2 cores

Master/ slave setting when more than one remote controls are used

A maximum of two remote controls can be connected to one indoor unit (or one group of indoor units.)

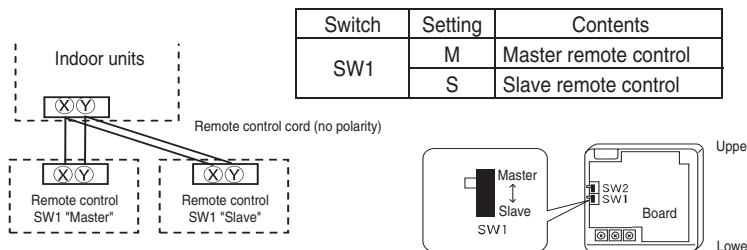

Set SW1 to "Slave" for the slave remote control. It was factory set to "Master" for shipment.
 Note: The setting "Remote control sensor enabled" is only selectable with the master remote control in the position where you want to check room temperature.
 The air-conditioner operation follows the last operation of the remote control regardless of the master/ slave setting of it.

The indication when power source is supplied

When power source is turned on, the following is displayed on the remote control until the communication between the remote control and indoor unit settled.

Master remote control : " WAIT M"
 Slave remote control : " WAIT S"

At the same time, a mark or a number will be displayed for two seconds first.
 This is the software's administration number of the remote control, not an error cord.

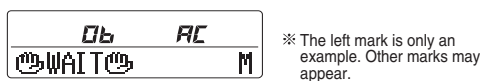

When remote control cannot communicate with the indoor unit for half an hour, the below indication will appear.
 Check wiring of the indoor unit and the outdoor unit etc.



The range of temperature setting

When shipped, the range of set temperature differs depending on the operation mode as below.

Heating : 16-30°C (55-86°F)

Except heating (cooling, fan, dry, automatic) : 18-30°C (62-86°F)

● **Upper limit and lower limit of set temperature can be changed with remote control.**

Upper limit setting: valid during heating operation. Possible to set in the range of 20 to 30°C (68 to 86°F).

Lower limit setting: valid except heating (automatic, cooling, fan, dry) Possible to set in the range of 18 to 26°C (62 to 79°F).

When you set upper and lower limit by this function, control as below.

1. When ⑫ TEMP RANGE SET, remote control function of function setting mode is "INDN CHANGE" (factory setting),
 [If upper limit value is set]

During heating, you cannot set the value exceeding the upper limit.

- [If lower limit value is set]

During operation mode except heating, you cannot set the value below the lower limit.

2. When ⑫ TEMP RANGE SET, remote control function of function setting mode is "NO INDN CHANGE"
 [If upper limit value is set]

During heating, even if the value exceeding the upper limit is set, upper limit value will be sent to the indoor unit.
 But, the indication is the same as the temperature set.

- [If lower limit value is set]

During except heating, even if the value lower than the lower limit is set, lower limit value will be sent to the indoor unit.
 But, the indication is the same as the temperature set.

● **How to set upper and lower limit value**

1. Stop the air-conditioner, and press [ON/OFF] (SET) and [MODE] (MODE) button at the same time for over three seconds.

The indication changes to "FUNCTION SET ▼".

2. Press [TEMP] button once, and change to the "TEMP RANGE ▲" indication.
3. Press [ON/OFF] (SET) button, and enter the temperature range setting mode.
4. Select "UPPER LIMIT ▼" or "LOWER LIMIT ▲" by using [UP] [DOWN] button.
5. Press [ON/OFF] (SET) button to fix.

6. When "UPPER LIMIT ▼" is selected (valid during heating)

① Indication: "TEMP RANGE SET UP" → "UPPER 30°C ▼"

② Select the upper limit value with temperature setting button [UP] [DOWN]. Indication example: "UPPER 26°C ▼ ▲" (blinking)

③ Press [ON/OFF] (SET) button to fix. Indication example: "UPPER 26°C" (Displayed for two seconds)

After the fixed upper limit value displayed for two seconds, the indication will return to "UPPER LIMIT ▼".

7. When "LOWER LIMIT ▲" is selected (valid during cooling, dry, fan, automatic)

① Indication: "TEMP RANGE SET UP" → "LOWER 18°C ▲"

② Select the lower limit value with temperature setting button [UP] [DOWN]. Indication example: "LOWER 24°C ▼ ▲" (blinking)

③ Press [ON/OFF] (SET) button to fix. Indication for example: "LOWER 24°C" (Displayed for two seconds)

After the fixed lower limit value displayed for two seconds, the indication will return to "LOWER LIMIT ▼".

8. Press [ON/OFF] button to finish.

• It is possible to finish by pressing [ON/OFF] button on the way, but unfinished change of setting is unavailable.

• During setting, if you press [RESET] (RESET) button, you return to the previous screen.

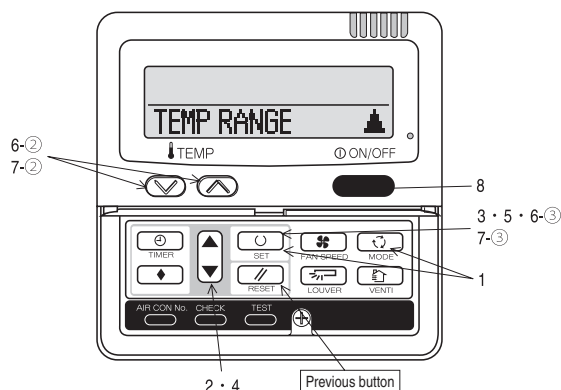

The functional setting

● The initial function setting for typical using is performed automatically by the indoor unit connected, when remote control and indoor unit are connected.
 As long as they are used in a typical manner, there will be no need to change the initial settings.
 If you would like to change the initial setting marked "○", set your desired setting as for the selected item.
 The procedure of functional setting is shown as the following diagram.

[Flow of function setting]

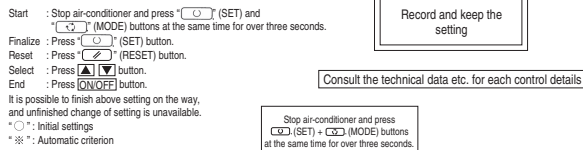

Note 1: The initial setting marked "⊞" is decided by connected indoor and outdoor unit, and is automatically defined as following table.

Function No.	Item	Default	Model
Remote control function02	AUTO RUN SET	AUTO RUN ON	"Auto-RUN" mode selectable indoor unit.
	AUTO RUN OFF	AUTO RUN OFF	Indoor unit without "Auto-RUN" mode
Remote control function06	FAN SPEED SW	⊞ VALID	Indoor unit with two or three step of air flow setting
		⊞ INVALID	Indoor unit with only one of air flow setting
Remote control function07	LOUVER SW	⊞ VALID	Indoor unit with automatically swing louver
		⊞ INVALID	Indoor unit without automatically swing louver
Remote control function13	1/1 FAN	HI-MID-10	Indoor unit with three step of air flow setting
		HI-LO	Indoor unit with two step of air flow setting
		HI-MID	Indoor unit with only one of air flow setting
Remote control function15	MODEL TYPE	HEAT PUMP	Heat pump unit
	COOLING ONLY		Exclusive cooling unit

Note 3: As for plural indoor unit, set indoor functions to each master and slave indoor unit.
 But only master indoor unit is received the setting change of indoor unit function "05 EXTERNAL INPUT" and "06 PERMISSION / PROHIBITION".

Function	setting	Function	setting
01 ESP SET	VALID ○ INVALID ⊞	02 FAN SPEED SET	STANDARD ⊞ HIGH SPEED 1 ⊞ HIGH SPEED 2 ⊞
02 AUTO RUN SET	AUTO RUN ON ⊞ AUTO RUN OFF ⊞	03 FILTER SIGN SET	INDICATION OFF ○ TYPE 1 ○ TYPE 2 ○ TYPE 3 ○ TYPE 4 ○
03 TEMP SW	VALID ○ INVALID ⊞	04 POSITION	POSITION STOP ○ FREE STOP ○
04 MODE SW	VALID ○ INVALID ⊞	05 EXTERNAL INPUT	LEVEL INPUT ○ PULSE INPUT ○
05 ON/OFF SW	VALID ○ INVALID ⊞	06 PERMISSION/PROHIBITION	INVALID ○ VALID ○
06 FAN SPEED SW	VALID ⊞ INVALID ⊞	07 EMERGENCY STOP	INVALID ○ VALID ○
07 LOUVER SW	VALID ○ INVALID ⊞	08 SP OFFSET	OFFSET +3.0℃ ○ OFFSET +2.0℃ ○ OFFSET +1.0℃ ○ NO OFFSET ○
08 TIMER SW	VALID ○ INVALID ⊞	09 RETURN AIR TEMP	OFFSET +2.0℃ ○ OFFSET +1.5℃ ○ OFFSET +1.0℃ ○ NO OFFSET ○
09 SENSOR SET	SENSOR OFF ○ SENSOR ON ○ SENSOR +3.0℃ ○ SENSOR +2.0℃ ○ SENSOR +1.0℃ ○ SENSOR -1.0℃ ○ SENSOR -2.0℃ ○ SENSOR -3.0℃ ○	10 FAN CONTROL	LOW FAN SPEED ○ SET FAN SPEED ○ INTERMITTENCE ○ FAN OFF ○
10 AUTO RESTART	INVALID ○ VALID ○	11 FROST PREVENTION TEMP	TEMP HIGH ○ TEMP LOW ○
11 VENT LINK SET	NO VENT ○ VENT LINK ○ NO VENT LINK ○	12 FROST PREVENTION CONTROL	FAN CONTROL ON ○ FAN CONTROL OFF ○
12 TEMP RANGE SET	INDEN CHANGE ○ NO INDEN CHANGE ○	13 DRAIN PUMP LINK	○ ○ ○ AND ○ ○ ○ AND ○ AND ○ ○
13 1/1 FAN	HI-MID-LO ⊞ HI-LO ⊞ HI-MID ⊞ 1 FAN SPEED ⊞	14 SP FAN REMAINING	NO REMAINING ○ 0.5 HOUR ○ 1 HOUR ○ 2 HOUR ○ 6 HOUR ○
14 POSITION	POSITION STOP ○ FREE STOP ○	15 SP FAN REMAINING	NO REMAINING ○ 0.5 HOUR ○ 1 HOUR ○ 2 HOUR ○ 6 HOUR ○
15 MODEL TYPE	HEAT PUMP ⊞ COOLING ONLY ⊞	16 SP FAN INTERMITTENCE	NO REMAINING ○ 5min OFF 5min ON ○ 5min OFF 10min ON ○ 5min OFF 15min ON ○
16 EXTERNAL CONTROL SET	INDIVIDUAL ○ FOR ALL UNITS ○	17 PRESSURE CONTROL	STANDARD ⊞ LOW ⊞
17 ROOM TEMP INDICATION SET	INDICATION OFF ○ INDICATION ON ○		
18 SIGN INDICATION	INDICATION ON ○ INDICATION OFF ○		
19 °C/°F SET	℃ ○ ℉ ○		

Note2: Fan setting of "HIGH SPEED"

Fan tap	Indoor unit air flow setting					
	Std1	Std2	Std3	Std4	Std5	Std6
FAN SPEED SET	UH - HI - Me - Lo	Hi - Me - Lo	Hi - Lo	Hi - Me		
HIGH SPEED1, 2	UH - UH - Hi - Me	UH - Hi - Me	UH - Me	UH - Hi		

[Initial function setting of some indoor unit is "HIGH SPEED".

The filter sign is indicated after running for 180 hours.
 The filter sign is indicated after running for 600 hours.
 The filter sign is indicated after running for 1000 hours.
 The filter sign is indicated after running for 1000 hours, then the indoor unit will be stopped by computation after 24 hours.

If you change the indoor function "04 POSITION", you must change the remote control function "14 POSITION" accordingly.
 You can select the lower stop position in the four.
 The louver can stop at any position.

With the VRF series, it is used to stop all indoor units connected with the same outdoor unit immediately.
 When stop signal is inputted from remote on-off terminal "CNT-6", all indoor units are stopped immediately.

To be reset for producing +3.0℃ increase in temperature during heating.
 To be reset for producing +2.0℃ increase in temperature during heating.
 To be reset for producing +1.0℃ increase in temperature during heating.

To be reset producing +2.0℃ increase in return air temperature of indoor unit.
 To be reset producing +1.5℃ increase in return air temperature of indoor unit.
 To be reset producing +1.0℃ increase in return air temperature of indoor unit.

To be reset producing -1.0℃ increase in return air temperature of indoor unit.
 To be reset producing -1.5℃ increase in return air temperature of indoor unit.
 To be reset producing -2.0℃ increase in return air temperature of indoor unit.

When heating thermostat is OFF, fan speed is low speed.
 When heating thermostat is OFF, fan speed is set speed.

When heating thermostat is OFF, fan speed is operated intermittently.
 When heating thermostat is OFF, the fan is stopped.
 When the remote thermostat is working, "FAN OFF" is set automatically.
 Do not set "FAN OFF" when the indoor unit's thermostat is working.

Change of indoor heat exchanger temperature to start frost prevention control.

Working only with the Single split series.
 To control frost prevention, the indoor fan tap is raised.

Drain pump is run during cooling and dry.
 Drain pump is run during cooling, dry and heating.
 Drain pump is run during cooling, dry, heating and fan.
 Drain pump is run during cooling, dry and fan.

After cooling is stopped is OFF, the fan does not perform extra operation.
 After cooling is stopped is OFF, the fan perform extra operation for half an hour.
 After cooling is stopped is OFF, the fan perform extra operation for an hour.
 After cooling is stopped is OFF, the fan perform extra operation for two hours.
 After cooling is stopped is OFF, the fan perform extra operation for six hours.

After heating is stopped or heating thermostat is OFF, the fan does not perform extra operation.
 After heating is stopped or heating thermostat is OFF, the fan perform extra operation for half an hour.
 After heating is stopped or heating thermostat is OFF, the fan perform extra operation for two hours.
 After heating is stopped or heating thermostat is OFF, the fan perform extra operation for six hours.

During heating is stopped or heating thermostat is OFF, the fan perform intermittent operation for five minutes with low fan speed after twenty minutes OFF.
 During heating is stopped or heating thermostat is OFF, the fan perform intermittent operation for five minutes with low fan speed after five minutes' OFF.

Connected "OA Processing" type indoor unit, and is automatically defined.

Note * The mark cannot use SRK series.

ON/OFF button (finished)

How to set function

1. Stop air-conditioner and press **(SET)** **(MODE)** buttons at the same time for over three seconds, and the "FUNCTION SET ▼" will be displayed.



2. Press **(SET)** button.
3. Make sure which do you want to set, "FUNCTION ▼" (remote control function) or "I/U FUNCTION ▲" (indoor unit function).
4. Press **▲** or **▼** button.
Select "FUNCTION ▼" (remote control function) or "I/U FUNCTION ▲" (indoor unit function).

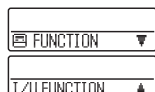

5. Press **(SET)** button.

6. 【On the occasion of remote control function selection】

- ① "DATA LOADING" (Indication with blinking)

↓
Display is changed to "01 EXP SET".

- ② Press **▲** or **▼** button.
"No. and function" are indicated by turns on the remote control function table, then you can select from them.
(For example)

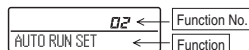

- ③ Press **(SET)** button.
The current setting of selected function is indicated.
(for example) "AUTO RUN ON" ← If "02 AUTO RUN SET" is selected

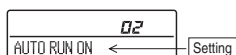

- ④ Press **▲** or **▼** button.
Select the setting.

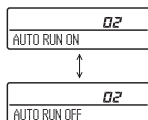

- ⑤ Press **(SET)** button.
"SET COMPLETE" will be indicated, and the setting will be completed.
Then after "No. and function" indication returns, Set as the same procedure if you want to set continuously, and if to finish, go to 7.



7. Press **ON/OFF** button.
Setting is finished.

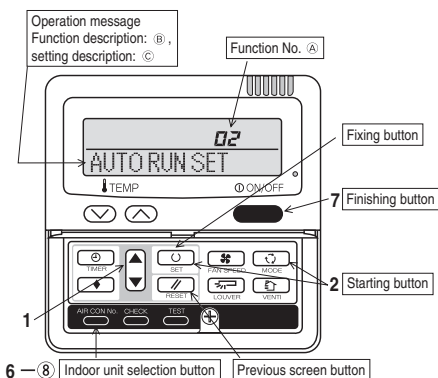

【On the occasion of indoor unit function selection】

- ① "DATA LOADING" (Blinking for 2 to 23 seconds to read the data)

↓
Indication is changed to "02 FAN SPEED SET".
Go to ②.

【Note】

- (1) If plural indoor units are connected to a remote control, the indication is "I/U 000" (blinking) ← The lowest number of the indoor unit connected is indicated.

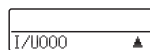

- (2) Press **▲** or **▼** button.
Select the number of the indoor unit you are to set
If you select "ALL UNIT ▼", you can set the same setting with all unites.

- (3) Press **(SET)** button.

- ② Press **▲** or **▼** button.
"No. and function" are indicated by turns on the indoor unit function table, then you can select from them.
(For example)

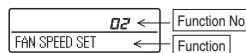

- ③ Press **(SET)** button.
The current setting of selected function is indicated.
(For example) "STANDARD" ← If "02 FAN SPEED SET" is selected.

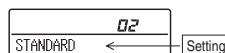

- ④ Press **▲** or **▼** button.
Select the setting.

- ⑤ Press **(SET)** button.
"SET COMPLETE" will be indicated, and the setting will be completed.
Then after "No. and function" indication returns, set as the same procedure if you want to set continuously, and if to finish, go to 7.



※ When plural indoor units are connected to a remote control, press the **AIR CON No.** button, which allows you to go back to the indoor unit selection screen. (example "I/U 000 ▲")

- It is possible to finish by pressing **ON/OFF** button on the way, but unfinished change of setting is unavailable.
- During setting, if you press **(RESET)** button, you return to the previous screen.
- Setting is memorized in the control and it is saved independently of power failure.

【How to check the current setting】

When you select from "No. and function" and press set button by the previous operation, the "Setting" displayed first is the current setting.
(But, if you select "ALL UNIT ▼", the setting of the lowest number indoor unit is displayed.)

(c) Operation and setting from wired remote control

Blank : Not compatible
 — : No function on remote control
 ○ : Correspondence
 △ : Corresponding part

Setting & display item		Description	RC-EX3A	RC-E5	
1.Remote control network					
1	Control plural indoor units by a single remote control	A remote control can control plural indoor units up to 16 (in one group of remote control network). An address is set to each indoor unit.	○	○	
2	Main/sub setting of remote controls	A pair of remote controls (including optional wireless remote control) can be connected within the remote control network. Set one to "Main" and the other to "Sub".	○	○	
2.TOP screen, Switch manipulation					
1	Menu	"Control", "State", or "Details" can be selected. (3-8)	○	—	
2	Operation mode	"Cooling", "Heating", "Fan", "Dry" or "Auto" can be set.	○	○	
3	Set temp.	"Set temperature" can be set by 0.5°C interval.	○	○	
4	Air flow direction	"Air flow direction" [Individual flap control] can be set. Select Enable or Disable for the "3D AUTO".	○	△	
5	Fan speed	"Fan speed" can be set.	○	○	
6	Timer setting	"Timer operation" can be set.	○	○	
7	ON/OFF	"On/Off operation of the system" can be done.	○	○	
8	F1 SW	The system operates and is controlled according to the function specified to the F1 switch.	○	—	
9	F2 SW	The system operates and is controlled according to the function specified to the F2 switch.	○	—	
3.Useful functions					
1	Individual flap control	The moving range (the positions of upper limit and lower limit) of the flap for individual flap can be set.			
2	Anti draft setting When the panel with the anti-draft function is assembled.	When the panel with the anti draft function is assembled, select to Enable or Disable the anti draft setting for each operation mode and for each blow outlet.			
3	Timer settings	Set On timer by hour	The period of time to start operation after stopping can be set. • The period of set time can be set within range of 1hour-12hours (1hr interval). • The operation mode, set temp. and fan speed at starting operation can be set.	△	—
		Set Off timer by hour	The period of time to stop operation after starting can be set. • The period of set time can be set within range of 1hour-12hours (1hr interval).	○	○
		Set On timer by clock	The clock time to start operation can be set. • The set clock time can be set by 5 minutes interval. • [Once (one time only)] or [Everyday] operation can be switched. • The operation mode, set temp and fan speed at starting operation can be set.	△	○
		Set Off timer by clock	The clock time to stop operation can be set. • The set clock time can be set by 5 minutes interval. • [Once (one time only)] or [Everyday] operation can be switched.	○	○
		Confirmation of timer settings	Status of timer settings can be seen.	○	—
4	Favorite setting [Administrator password]	Set the operation mode, setting temperature, air flow capacity and air flow direction for the choice setting operations. Set them for the Favorite set 1 and the Favorite set 2 respectively.	○	—	
5	Weekly timer	On timer and Off timer on weekly basis can be set. • 8-operation patterns per day can be set at a maximum. • The setting clock time can be set by 5 minutes interval. • Holiday setting is available. • The operation mode, set temp and fan speed at starting operation can be set.	○	○	
6	Home leave mode [Administrator password]	When leaving home for a long period like a vacation leave, the unit can be operated to maintain the room temperature not to be hotter in summer or not to be colder in winter. • The judgment to switch the operation mode (Cooling ⇄ Heating) is done by the both factors of the set temp. and outdoor air temp. • The set temp. and fan speed can be set.	○	—	
7	External Ventilation When the ventilator is combined.	On/Off operation of the external ventilator can be done. It is necessary to set from [Menu] ⇒ [Service setting] ⇒ [R/C function settings] ⇒ [Ventilation setting]. • If the "Independent" is selected for the ventilation setting, the ventilator can be operated or stopped.	○	○	
8	Select the language	Select the language to display on the remote control. • Select from English, German, French, Spanish, Italian, Dutch, Turkish, Portuguese, Russian, Polish, Japanese and Chinese.	○	—	
9	Look, look	Indoor temperature, outdoor temperature and power consumption are indicated.	△	—	
10	Power consumption indication	The power consumption of today, this week and this year is indicated by a chart. It is possible to compare with yesterday, last week and last year. • This item may not indicate depending on indoor and outdoor units which are combined.	○	—	
4. Energy-saving setting		Administrator password			
1	Sleep timer	To prevent the timer from keeping ON, set hours to stop operation automatically with this timer. • The selectable range of setting time is from 30 to 240 minutes. (10 minutes interval) • When setting is "Enable", this timer will activate whenever the ON timer is set.	○	—	
2	Peak-cut timer	Power consumption can be reduced by restructuring the maximum capacity. Set the [Start time], the [End time] and the capacity limit % (Peak-cut %). • 4-operation patterns per day can be set at maximum. • The setting time can be changed by 5-minutes interval. • The selectable range of capacity limit % (Peak-cut %) is from 0% to 40-80% (20% interval). • Holiday setting is available.	○	—	
3	Automatic temp. set back	After the elapse of the set time period, the current set temp. will be set back to the [Set back time.] • The setting can be done in cooling and heating mode respectively. • Selectable range of the set time is from 20 min. to 120 min. (10 min. interval). • Set the [Set back temp.] by 1°C interval.	○	—	
4	Infrared sensor control (Motion sensor control) When the panel with the infrared sensor (motion sensor) is assembled.	When the infrared sensor (motion sensor) is used, it is necessary to set Enable or Disable for the "Power control" and the "Auto-off".	○	—	
5.Filter					
1	Filter sign reset	Filter sign reset	The filter sign can be reset.		
		Setting next cleaning date	The next cleaning date can be set.		
6.User setting					
1	Internal settings	Clock setting	The current date and time can be set or revised. • If a power failure continues no longer than 80 hours, the clock continues to tick by the built-in power source.	○	—
		Date and time display	[Display] or [Hide] the date and/or time can be set, and [12H] or [24H] display can be set.	○	—
		Summer time	When select [Enable], the +1hour adjustment of current time can be set. When select [Disable], the [Summer time] adjustment can be reset.	○	—
		Contrast	The contrast of LCD can be adjusted higher or lower.	○	—
		Backlight	Switching on/off a light can be set and period of the lighting time can be set within the range of 5sec-90 sec (5sec interval).	○	—
		Control sound	It can set with or without [Control sound (beep sound)] at touch panel.	○	—
	Operation lamp luminance	This is used to adjust the luminance of operation lamp.	○	—	

Setting & display item		Description	RC-EX3A	RC-E5	
2 Administrator settings [Administrator password]	Permission/Prohibition setting	• Permission/Prohibition setting of operation can be set. [On/Off] [Change set temp] [Change operation mode] [Change flap direction] [Change fan speed] [High power operation] [Energy-saving operation] [Timer] Request for administrator can be set. [Individual flap control] [Weekly timer] [Select the language] [Anti draft setting]	○	—	
	Outdoor unit silent mode timer	The period of time to operate the outdoor unit by prioritizing the quietness can be set. • The [Start time] and the [End time] for operating outdoor unit in silent mode can be set. • The period of the operation time can be set once a day by 5 minutes interval.	○	○	
	Setting temp. range	The upper/lower limit of temp. setting range can be set. • The limitation of indoor temp. setting range can be set for each operation mode in cooling and heating.	○	○	
	Temp increment setting	The temp increment setting can be changed by 0.5°C or 1.0°C.	○	○	
	Set temp. display	Ways of displaying setting temperatures can be selected.	○	○	
	R/C display setting	Register [Room name] [Name of I/U] Display [Indoor temp. display] or not. Display [Error code display] or not. Display [Heating stand-by display] [Defrost operation display] [Auto cooling/heating display] [Display temp of R/C, Room, Outdoor] or not	○	—	
	Change administrator password	The administrator password can be changed. (Default setting is "0000") The administrator password can be reset.	○	—	
F1/F2 function setting	Functions can be set for F1 and F2. Selectable functions: [High power operation], [Energy-saving operation], [Silent mode cont.], [Home leave mode], [Favorite set 1], [Favorite set 2] and [Filter sign reset].	○	—		
7. Service setting					
1 Installer settings [Service password]	Installation date	The [Installation date] can be registered. • When registering the [Installation date], the [Next service date] is displayed automatically. (For changing the [Next service date], please refer the item of [Service & Maintenance])	○	—	
	Company information	The [Company information] can be registered and can be displayed on the R/C. • The [Company] can be registered within 26 characters. • The [Phone No.] can be registered within 13 digits.	○	—	
	Test run	On/Off operation of the test run can be done.			
	Cooling test run	The [Cooling test run] can be done at 5°C of set temp. for 30 minutes.	○	○	
	Drain pump test run	Only drain pump can be operated.			
	Static pressure adjustment	In case of combination with only the ducted indoor unit which has a function of static pressure adjustment, the static pressure is adjustable. • It can be set for each indoor unit individually.		—	
	Change auto-address	The set address of each indoor unit decided by auto-address setting method can be changed to any other address.		—	
	Address setting of main IU	Main indoor unit address can be set. • Only the Main indoor unit can change operation mode and the Sub indoor units dominated by the Main indoor shall follow. • The Main indoor unit can domain 10 indoor units at a maximum.		—	
	IU back-up function	When a pair of indoor units (2 groups) is connected to one unit of remote control, it can be set Enable or Disable for the [IU rotation], [IU capacity back-up] and [IU fault back-up]	○	—	
	Infrared sensor setting (Motion sensor setting) When the panel with the infrared sensor (motion sensor) is assembled.	Set Enable or Disable for the infrared sensor detectors of indoor units connected to the remote control. If Disable is selected, it cannot be control the infrared sensor control for the energy-saving setting.	○	—	
Grill lifting operation	Set enable for automatic lifting panel operation. When automatic lifting panel is assembled.				
2 R/C function setting [Service password]	Main/Sub R/C	The R/C setting of [Main/Sub] can be changed.	○	—	
	Return air temp.	When two or more indoor units are connected to one unit of remote control, suction sensors, which are used for the judgement by thermostat, can be selected. • It can be selected from [Individual], [Master IU] and [Average temp].	○	—	
	R/C sensor	It can be set the mode to switch to the remote control sensor. It can be selected from cooling and heating.	○	△	
	R/C sensor adjustment	The offset value of [R/C sensor] sensing temp. can be set respectively in heating and cooling.	○	△	
	Operation mode	Enable or Disable can be set for each operation mode. Set the unit for setting temperatures. • °C or °F can be selected.	○	○	
	Fan speed	Fan speeds can be selected.	○	—	
	External input	When two or more indoor units are connected to one unit of remote control, the range to apply CnT inputs can be set.	○	○	
	Upper/lower flap control	[Stop at fixed position] or [Stop at any position] can be selected for the upper and lower louvers.	○	○	
	Left/right flap control	[Fixed position stop] or [Stop at any position] can be selected for the right and left louvers.	○	—	
	Ventilation setting	Combination control for ventilator can be set.	○	○	
	Auto-restart	The operation control method after recovery of power failure happened during operation can be set.	○	○	
	Auto temp. setting	[Enable] or [Disable] of [Auto temp. setting] can be selected.	○	—	
	Auto fan speed	[Enable] or [Disable] of [Auto fan speed] can be selected.	○	—	
	3 IU settings [Service password]	Fan speed setting	The fan speed for indoor units can be set.		—
		Filter sign	The setting of filter sign display timer can be done from following patterns.		—
External input 1		The connect of control by external input 1 can be changed.	△	△	
External input 1 signal		The type of external input 1 signal can be changed.	○	○	
External input 2		The connect of control by external input 2 can be changed.		—	
External input 2 signal		The type of external input 2 signal can be changed.		—	
Heating thermo-OFF temp. adjustment		The judgement temp. of heating thermo-off can be adjusted within the range from 0 to +3°C (1°C interval) .		—	
Return temperature adjustment		The sensing temp. of return air temp. sensor built in the indoor unit can be adjusted within the range of ±2°C.		—	
Fan control in cooling thermo-OFF		Fan control, when the cooling thermostat is turned OFF, can be changed.		—	
Fan control in heating thermo-OFF		Fan control, when the heating thermostat is turned OFF, can be changed.	△	△	
Anti-frost temp.		Judgment temperature for the anti-frost control during cooling can be changed.		—	
Anti-frost control		When the anti-frost control of indoor unit in cooling is activated, the fan speed can be changed.		—	
Drain pump operation		In any operation mode in addition to cooling and dry mode, the setting of drain pump operation can be done.		—	
Keep fan operating after cooling is stopped		The time period residual fan operation after stopping or thermo-off in cooling mode can be set.		—	
Keep fan operating after heating is stopped		The time period residual fan operation after stopping or thermo-off in heating mode can be set.		—	
Intermittent fan operation in heating		The fan operation rule following the residual fan operation after stopping or thermo-off in heating mode can be set.		—	
Fan circulator operation		In case that the fan is operated as the circulator, the fan control rule can be set.		—	
Control pressure adjust		When only the OA processing units are operated, control pressure value can be changed.		—	
Auto operation mode		The [Auto rule selection] for switching the operation mode automatically can be selected from 3 patterns.		—	
Thermo. rule setting		When selecting [Outdoor air temp. control], the judgment temp can be offset by outdoor temp. .		—	
Auto fan speed control		Auto switching range for the auto fan speed control can be set.		—	
IU overload alarm		If the difference between the setting temperature and the suction temperature becomes larger than the temperature difference set for the overload alarm, at 30 minutes after the start of operation, the overload alarm signal is transmitted from the external output (CnT-5).	○	—	
External output setting *1	Functions assigned to the external outputs 1 to 4 can be changed.	△	—		

Setting & display item		Description	RC-EX3A	RC-E5
4. Service & Maintenance [Service password]	IU address	Max 16 indoor units can be connected to one remote control, and all address No. of the connected indoor units can be displayed. • The indoor unit conforming to the address No. can be identified by selecting the address No. and tapping [Check] to operate the indoor fan.	○	—
	Next service date	The [Next service date] can be registered. • The [Next service date] and [Company information] is displayed on the message screen.	○	—
	Operation data	The [Operation data] for indoor unit and outdoor unit can be displayed.	○	○
	Error display			
	Error history	The error history can be displayed.		
	Display anomaly data	The operation data just before the latest error stop can be displayed.	○	△
	Erase anomaly data	Anomaly operation data can be erased.		
	Reset periodical check	The timer for the periodical check can be reset.		
	Saving IU settings	The I/U settings memorized in the indoor PCB connected to the remote control can be saved in the memory of the remote control.	○	—
	Special settings	[Erase IU address] [CPU reset] [Restore of default setting] [Touch panel calibration]	○	△
	Indoor unit capacity display	Address No. and capacities of indoor units connected to the remote control are displayed.	○	—
8. Contact company	Shows registered [Contact company] and [Contact phone].	○	—	
9. Inspection				
Confirmation of Inspection	This is displayed when any error occurs.	○	—	
10. PC connection				
USB connection	Weekly timer setting and etc., can be set from PC.	○	—	

◆ Listed items may not function depending on the specifications of indoor and outdoor units which are combined.

*1 It supports only following functions.

Operation output / Heating output / Compressor ON output / Inspection (Error) output / Cooling output / Fan operation output 1 / Fan operation output 2 / Fan operation output 3 / Defrost/oil return output

(2) Interface kit (SC-BIKN2-E)

※ When RC-EX3A is connected, please use SC-BIKN2-E by all means.

RKZ012A099

Accessories included in package

Be sure to check all the accessories included in package.

No.	Part name	Quantity
①	Indoor unit's connection cable (cable length: 1.8m)	1
②	Wood screws (for mounting the interface: ø4x 25)	2
③	Tapping screws (for the cable clamp and the interface mounting bracket)	3
④	Interface mounting bracket	1
⑤	Cable clamp (for the indoor unit's connection cable)	1
⑥	CnT terminal connection cable (total cable length: 0.5m)	1

Safety precautions

Before use, please read these Safety precautions thoroughly before installation.

- All the cautionary items mentioned below are important safety related items to be taken into consideration, so be sure to observe them at all times.

⚠ Warning Incorrect installation could lead to serious consequences such as death, major injury or environmental destruction.

- Symbols used in these precautions

❗ Always go along these instruction.

- After completed installation, carry out trial operation to confirm no anomaly, and ask the user to keep this installation manual in a good place for future reference.

⚠ Warnings



- **Installation must be carried out by a qualified installer.**
If you install it by yourself, it may cause an electric shock, fire and personal injury, as a result of a system malfunction.
- **Install it in full accordance with the installation manual.**
Incorrect installation may cause an electric shock, fire and personal injury.
- **Electrical work must be carried out by a qualified electrician in accordance with the technical standard for electrical equipment, the indoor wiring standard and this installation manual.**
Incorrect installation may cause an electric shock, fire and personal injury.
- **Use the specific cables for wiring. And connect all the cables to terminals or connectors securely and clamp them with cable clamps in order for external forces not to be transmitted to the terminals directly.**
Incomplete connection may cause malfunction, and lead to heat generation and fire.
- **Use the original accessories and specified components for installation.**
If the parts other than those prescribed by us are used, it may cause an electric shock, fire and personal injury.

Connecting the indoor unit's connection cable to the interface

- ① Remove the upper case of the interface.
 - Remove 2 screws from the interface casing before removal of upper casing.
- ② Connect the indoor unit's connection cable to the interface.
 - Connect the connector of the indoor unit connection cable to the connector on the interface's circuit board.
- ③ Fix the indoor unit's connection cable with the cable clamp.
 - Cable can be brought in from the top or from the back.
 - Cut out the punch-outs for the connection cables running into the casing with cutter.
- ④ Connect the indoor unit's connection cable to the indoor control PCB.
 - Connect the indoor unit's connection cable to the indoor control PCB securely.
 - Clamp the connection cable to the indoor control box securely with the cable clamp provided as an accessory.
 - Regarding the cable connection to the indoor unit, refer to the installation manual for indoor unit.

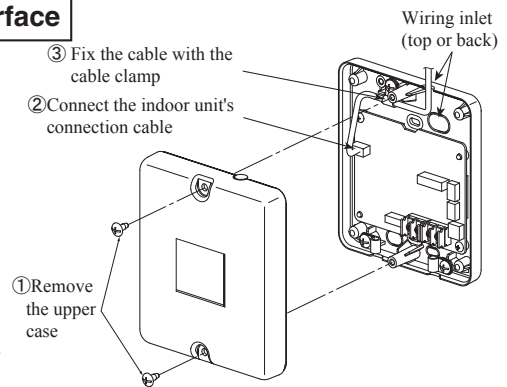

Name of each part of the interface

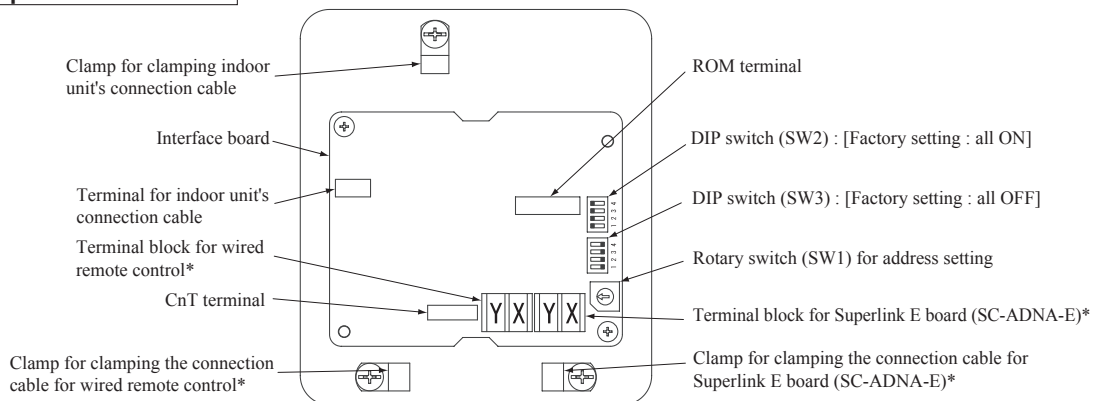

*Either the connection cables of Superlink E board (SC-ADNA-E) or of wired remote control is connectable.

Switch	Setting	Function	Switch	Setting	Function
SW2-1	ON**	CnT level input	SW2-3	ON**	External input (CnT input)
	OFF	CnT pulse input		OFF	Operation permission/prohibition (CnT input)
SW2-2	ON**	Wired remote control : Enable	SW2-4	ON**	Annual cooling : Enable***
	OFF	Wired remote control : Disable		OFF	Annual cooling : Disable***

** Factory setting

*** Indoor fan control at low outdoor air temperature in cooling

Installation of the interface

- Install the interface within the range of the connection cable length (approximately 1.3m) from the indoor unit.
 - Be sure not to extend the connection cable on site. If the connection cable is extended, malfunction may occur.
 - Fix the interface on the wall, pillar or the like.
- Don't install the interface and wired remote control at the following places.
- Places exposed to direct sunlight
 - Places near heating devices
 - High humidity places
 - Surfaces where are enough hot or cold to generate condensation
 - Places exposed to oil mist or steam directly
 - Uneven surface

Mounting the interface directly on a wall

- ① Mount the lower casing of the interface on a flat surface with wood screws provided as standard accessory.
- ② Mount the upper casing.

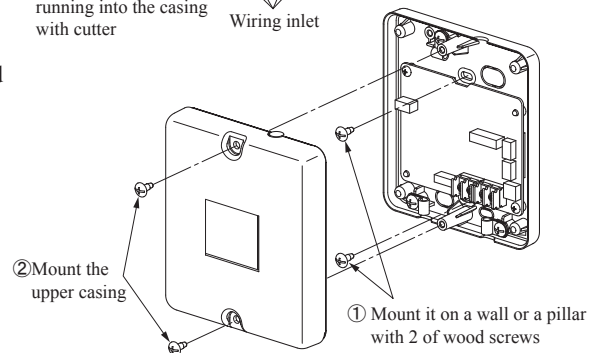
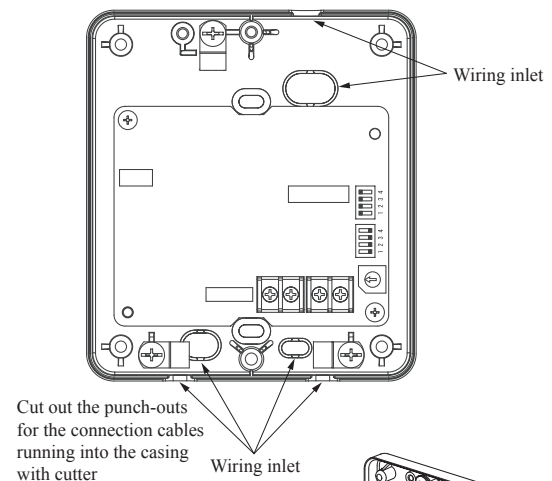

Recessing the interface in the wall

- ① Recess the electrical box (procured locally) and connection cables in the wall.
- ② Mount the lower casing of the interface to the electrical box with M4 screws (procured locally).
- ③ Mount the upper casing.

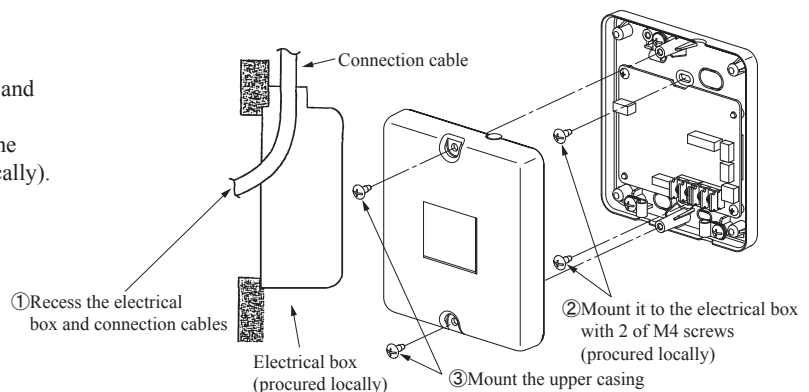

Mounting the interface with the mounting bracket

- ① Mount the upper casing.
- ② Mount the mounting bracket to the interface with tapping screws provided as standard accessory.
- ③ Mount the mounting bracket on wall or the like with wood screws provided as standard accessory.

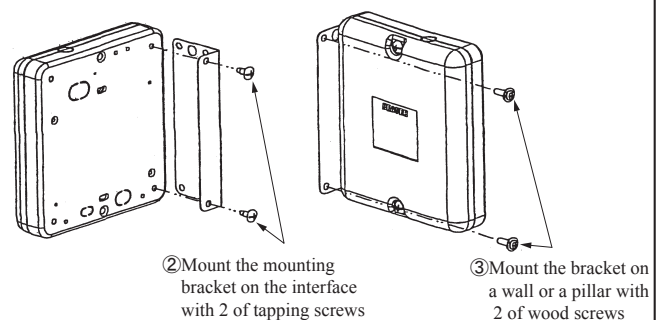

Installation check items

- Are the connection cables connected securely to the terminal blocks and connectors?
- Are the thickness and length of the connection cables conformed with the standard?

Functions of CnT connector

It is available to operate the air-conditioner and to monitor the operation status with the external control unit (remote display) by sending the input/output signal through CnT connector on the indoor control PCB.

- ① Connect a external remote control unit (procured locally) to CnT terminal.
- ② In case of the pulse input, switch OFF the DIP switch SW2-1 on the interface PCB.
- ③ When setting operation permission/prohibition mode, switch OFF the DIP switch SW2-3 on the interface PCB.

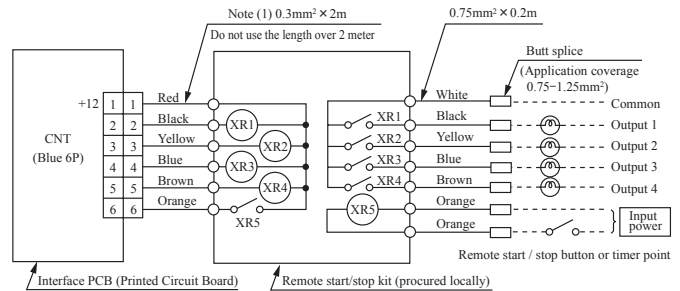

Input/Output	Function	Output signal		Content
		Relay	ON/OFF	
Output 1	Operation output	XR ₁	ON	During air-conditioner operation
Output 2	Heating output	XR ₂	ON	During heating operation
Output 3	Compressor operation output	XR ₃	ON	During compressor running
Output 4	Malfunction output	XR ₄	ON	During anomalous stop

- XR₁₋₄ are for the DC 12V relay
- XR₅ is a DC 12/24V or AC 220-240V relay
- CnT connector (local) maker, model

Connector	Molex	5264-06
Terminals	Molex	5263T

Input/Output	Function	SW2-1		SW2-3		Air-conditioner	Operation by remote control			
		Setting		Input signal						
				Level/Pulse	XR ₅					
Input	External control input	ON*	Level input	ON*	Level	OFF→ON	External input	ON	Allowed	
				OFF	Level	ON→OFF	Operation permission	OFF		
		OFF	Pulse input	ON*	Pulse	OFF→ON	External input	OFF→ON	ON	Allowed
				OFF	Level	ON→OFF	Operation permission	OFF	Not allowed	

* Factory setting

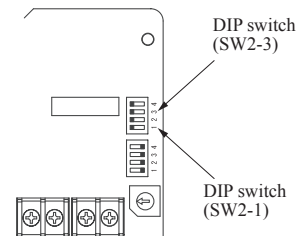

In case of the remote control (RC-EX3A), the external outputs (1 – 4) and the external input can be changed using the function setting of remote control. For the setting method, refer to the installation manual. Also refer to the technical manual to know how it is adapted to the function setting for the external outputs and input, at the indoor unit side.

Connection of Superlink E board

Regarding the connection of Superlink E board, refer to the installation manual of Superlink E board.

For electrical work, power source for all of units in the Superlink system must be turned OFF.

- ① Switch ON the DIP switch SW2-2 (Factory setting: ON) on the interface PCB.

Caution: Wireless remote control attached to the indoor unit can be used in parallel, after connecting the wired remote control. However, some of functions other than the basic functions such as RUN/STOP, temperature setting, etc. may not work properly and may have a mismatch between the display and the actual behavior.

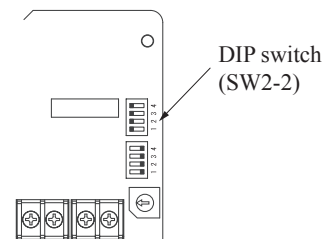

- ② Wiring connection between the interface and the Superlink E board.

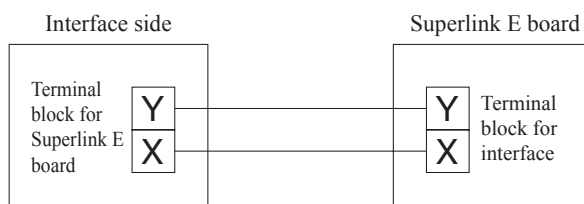

No.	Names of recommended signal wires
1	Shielded wire
2	Vinyl cabtyre round cord
3	Vinyl cabtyre round cable
4	Vinyl insulated wire vinyl sheathed cable for control

Within 200 m 0.5 mm² × 2 cores
 Within 300 m 0.75 mm² × 2 cores
 Within 400 m 1.25 mm² × 2 cores
 Within 600 m 2.0 mm² × 2 cores

- ③ Clamp the connection cables with cable clamps.

Connection of wired remote control

Regarding the connection of wired remote control, refer to the installation manual of wired remote control.

- ① Switch ON the DIP switch SW2-2 (Factory setting : ON) on the interface PCB.

Caution: Wireless remote control attached to the indoor unit can be used in parallel, after connecting the wired remote control. However, some of functions other than the basic functions such as RUN/STOP, temperature setting, etc. may not work properly and may have a mismatch between the display and the actual behavior.

- ② Wiring connection between the interface and the wired remote control.

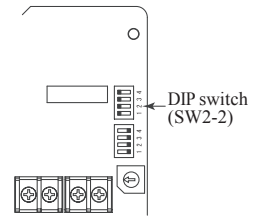

Installation and wiring of wired remote control

- Install the wired remote control with reference to the attached installation manual of wired remote control.
- 0.3mm² × 2 cores cable should be used for the wiring of wired remote control.
- Maximum length of wiring is 600m.

If the length of wiring exceeds 100m, change the size of cable as mentioned below.

100m-200m: 0.5mm² × 2 cores, 300m or less: 0.75mm² × 2 cores, 400m or less: 1.25mm² × 2 cores, 600m or less: 2.0mm² × 2 cores

However, cable size connecting to the terminal of wired remote control should not exceed 0.5mm². Accordingly if the size of connection cable exceeds 0.5mm², be sure to downsize it to 0.5mm² at the nearest section of the wired remote control and waterproof treatment should be done at the connecting section in order to avoid contact failure.

- Don't use the multi-core cable to avoid malfunction.
 - Keep the wiring of wired remote control away from grounding (Don't touch it to any metal frame of building, etc.).
 - Connect the connection cables to the terminal blocks of the wired remote control and the interface securely (No polarity).
- ③ Clamp the connection cables with cable clamps.

Control of multiple units by a single wired remote control

Multiple units (up to 16) can be controlled by a single wired remote control. In this case, all units connected with a single wired remote control will operate under the same mode and same setting temperature.

- ① Connect all the interface with 2 cores cables of wired remote control line.
- ② Set the address of indoor unit for remote control communication from "0" to "F" with the rotary switch SW1 on the interface PCB.
- ③ After turning the power ON, the address of indoor unit can be displayed by pressing [AIR CON No.] button on the wired remote control. Make sure all indoor units connected are displayed in order by pressing [▲] or [▼] button.

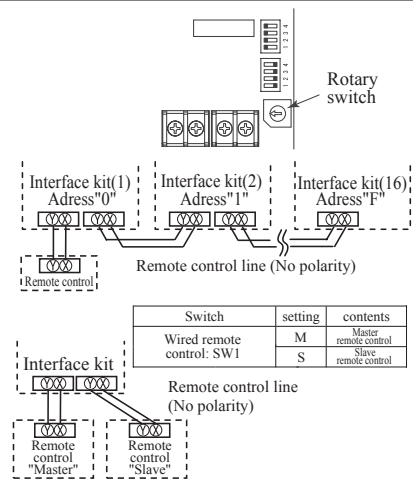

Master/Slave setting wired when 2 of wired remote control are used

Maximum two wired remote control can be connected to one indoor unit (or one group of indoor units)

- ① Set the DIP switch SW1 on the wired remote control to "Slave" for the slave remote control. (Factory setting : Master)
- Caution : Remote control sensor of the slave remote control is invalid.

- When using the wireless remote control in parallel with the wired remote control; Since temperature setting range of wired remote control is different from that of wireless remote control, please adjust the setting range of wired remote control to be the same setting range of wireless remote control by following procedure. (The set temperature may not be displayed correctly on the wireless remote control, unless change of temperature setting range is done.) Changing procedure of temperature setting range is as follows.

How to set upper and lower limit of temperature setting range

1. Stop the air-conditioner, and press [○] (SET) and [◀] (MODE) button at the same time for 3 seconds or more.
The indication changes to "FUNCTION SET ▼"
2. Press [▼] button once, and change to the "TEMP RANGE ▲" indication.
3. Press [○] (SET) button, and enter the temperature range setting mode.
4. Confirm that the "Upper limit ▼" is shown on the display.
5. Press [○] (SET) button to fix.
6. ① Indication: "UPPER 28°C ▼ ▲"
② Select the upper limit value 30°C with temperature setting button [▲]. "UPPER 30°C ▼" (blinking)
③ Press [○] (SET) button to fix. "UPPER 30°C" (Displayed for two seconds)
After the fixed upper limit value displayed for two seconds, the indication will return to "UPPER LIMIT ▼".
7. Press [▼] button once, "LOWER LIMIT ▲" is selected, press [○] (SET) button to fix.
① Indication: "LOWER 20°C ▼ ▲"
② Select the lower limit value 18°C with temperature setting button [▼]. "LOWER 18°C ▲" (blinking)
③ Press [○] (SET) button to fix. "LOWER 18°C" (Displayed for two seconds)
After the fixed lower limit value displayed for two seconds, the indication will return to "LOWER LIMIT ▼"
8. Press [ON/OFF] button to finish.
Temperature setting range

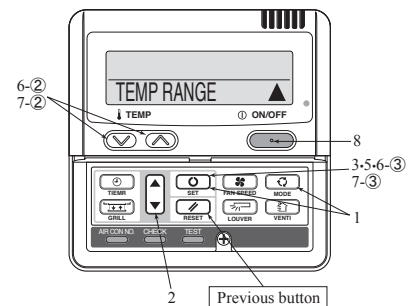

- It is possible to quit in the middle by pressing [ON/OFF] button, but the change of setting is incompleated.
- During setting, if pressing [RESET] button, it returns to the previous screen.

Mode	Temperature setting range
Cooling, Heating, Dry, Auto	18-30°C

(3) Superlink E board (SC-ADNA-E)

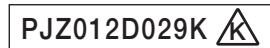

- Read and understand the instructions completely before starting installation.
- Refer to the instructions for both indoor and outdoor units.

Safety precautions

- Carefully read “Safety precautions” first. Follow the instructions for installation.
- Precautions are grouped into “Warning⚠” and “Caution⚠”. The “Warning⚠” group includes items that may lead to serious injury or death if not observed. The items included in the “Caution⚠” group also may lead to serious results under certain conditions. Both groups are crucial for safety installation. Read and understand them carefully.
- After installation, conduct the test operation of the device to check for any abnormalities. Describe how to operate the device to the customer following the installation instruction manual. Instruct the customer to keep this installation instruction for future reference.

⚠Warning

- This device should be installed by the dealer where you purchase the device or a licensed professional shop. If the device is incorrectly installed by the customer, it may result in electric shock or fire.
- Install the device carefully following the installation instruction. If the device is incorrectly installed, it may result in electric shock or fire.
- Use the accessory parts and specified parts for installation. If any parts that do not match the specifications are used, it may result in electric shock or fire.
- A person with the electrical service certification should conduct the service based on the “Technical standards for electrical facilities”, “Electrical Wiring Code”, and the installation instruction. If the work is done incorrectly, it may result in electric shock or fire.
- Wiring should be securely connected using the specified types of wire. No external force on the wire should be applied to any terminals. If a secure connection is not achieved, it may result in electric shock or fire.

⚠Caution

- Provide ground connection.
The ground line should never be connected to the gas supply piping, the water supply piping, the lightning conductor rod, nor the telephone ground. If the grounding is improper, it may result in electric shock.
- Do not install the device in the following locations.
 1. Where there is mist/spray of oil or steam such as kitchens.
 2. Where there is corrosive gases such as sulfuric acid gas.
 3. Where there is a device generating electromagnetic waves.
These may interfere with the control system resulting in the device becoming uncontrollable.
 4. Where flammable volatile materials such as paint thinner and gasoline may exist or where they are handled. This may cause a fire.

1 Application

Indoor-to-outdoor three core communication specification type 3 (since October 2007)

2 Accessories

SL E board	Metal box	Metal cover	Screw for ground
			M4x8 2 pieces
Pan head screws	Locking supports	Binding band	Grommet
φ4x8 2 pieces	To secure the print board and the metal box Made of nylon 4 pieces		

5 Connection outline

Note for setting the address

- Set the address between 00 and 47 for the previous Superlink connection and between 000 and 127 for the new Superlink connection. (*1)
- Do not set the address overlapping with those of the other devices in the network. (The default is 000)

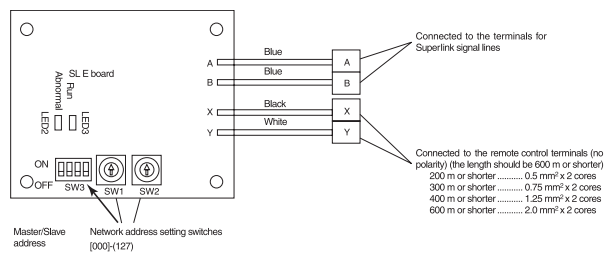

(*1) Whether the actual link is either the new Superlink or the previous Superlink depends on the models of the connected outdoor and indoor units. Consult the agent or the dealer.

3 Function

Allowing the central control SL1N-E, SL2NA-E, and SL4-AE/BE to control and monitor the commercial air-conditioner unit.

4 Control switching

Settings can be changed by the DIP switch SW3 on the SL E board as in the following.

Switch	Symbol	Switch	Remarks
SW3	1	ON	Master
		OFF (default)	Slave
	2	ON	Fixed previous protocol
		OFF (default)	Automatic adjustment of Superlink protocol
	3	ON	Indicates the forced operation stop when abnormality has occurred.
		OFF (default)	Indicates the status of running/stop as it is, when abnormality has occurred.
	4	ON	The hundredth address activated “1”
		OFF (default)	The hundredth address activated “0”

Signal line specification

Communication method	Previous Superlink	New Superlink
Line type	MVVS	MVVS
Line diameter	0.75 - 1.25mm ²	0.75/1.25mm ²
Signal line (total length)	up to 1000m	up to 1500/1000m (*2)
Signal line (maximum length)	up to 1000m	up to 1000m

(*2) Up to 1500 m for 0.75 mm², and up to 1000 m for 1.25 mm². Do not use 2.0 mm². It may cause an error.

(*3) Connect grounding on both ends of the shielding wire. For the grounding method, refer to the section “6 Installation”.

- (1) Set the Superlink network address with SW1 (tens place), SW2 (ones place), and SW3 (hundreds place).
- (2) Set the SL E board SW3-1 to be ON (Master) when using this without any remote control (no wired remote controller nor wireless remote control).
- (3) Set up the plural master/slave device using the DIP switches on the indoor unit board.
- (4) Set up the remote control master/slave device using the slide switch on the remote control board.
- (5) Set up "0" to "F" using the address rotary switch on the indoor unit board when controlling the indoor unit with the multiple remote control.

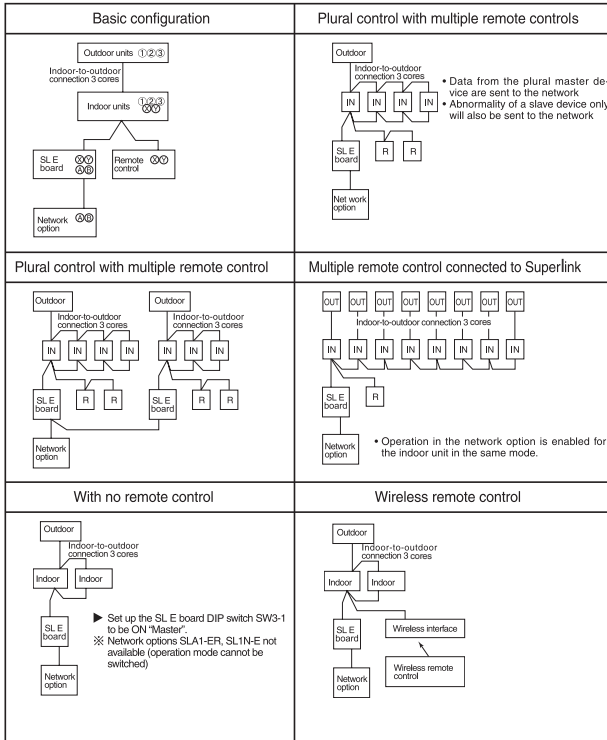

Connect grounding. Connect grounding for the power line to Ground ①, and grounding for the signal line to Ground ② or to the Ground on the indoor unit control box.

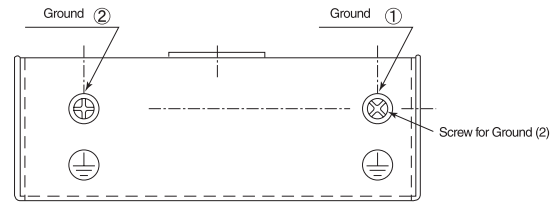

2. When connecting to the indoor unit control box (ceiling-concealed type and FDT type only):

- (1) Mount the SL E board in the control box using the locking supports.
- (2) Remove 6 bands from the box and put the wiring through the bands to be secured.

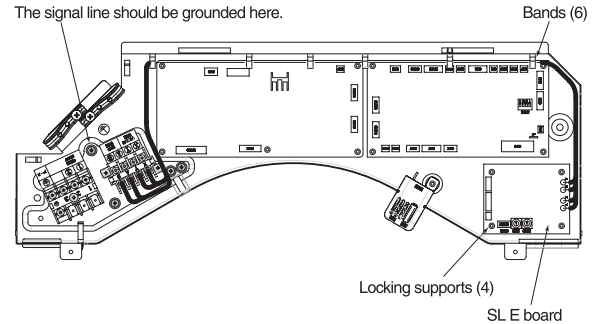

Electrical shock hazard make sure to turn the power off for servicing. Be cautious so that no abnormal force should be applied to the wiring. Do not let the SL E board hung by the wiring. Do not damage the board with a screwdriver. The board is sensitive to static electricity. Release the static electricity of your body before servicing. (You can do this by touching the control board which is grounded).

Location of installation

Install the device at the location where there are no electromagnetic waves nor where there is water and dust. The specified temperature range of the device is 0 to 40°C. Install the device at the location where the ambient temperature stays within the range. If it exceeds the specification, make sure to provide solution such as installing a cooling fan. When used outside of the range, it may cause abnormal operation.

6 Installation

1. When using the metal box (mounted on the indoor unit / mounted on the back of the remote control):

- (1) Mount the SL E board in the metal box using the locking supports.
- (2) Wiring should go through the provided grommet since then through the wiring to the hole on the Metal box. Secure the grommet after inserting the grommet into the Metal box as shown in below figure, then tie the wiring at the outlet of the unit using a binding band.

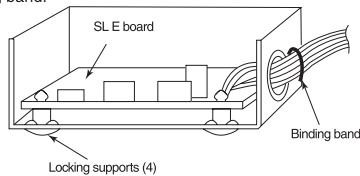

▲ When installed outside the indoor unit, put the metal cover on.

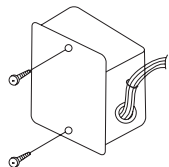

▲ When installed on the back of the remote control, mount it directly on the remote control bottom case.

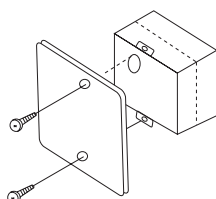

7 Indicator display

Check the LED 3 (green) and LED 2 (red) on the SL E board for flashing.

SL E board LEDs		Inspection mode	Display on the integrated network control device
Red	Green		
Off	Flashing	Normal communication	
Off	Off	<ul style="list-style-type: none"> Disconnection in the remote control communication line (X or Y) Short-circuit in the remote control communication line (between X and Y) Faulty indoor unit remote control power Faulty remote control communication circuit Faulty CPU on SL E board 	No corresponding unit number
One flash	Flashing	<ul style="list-style-type: none"> Disconnection in the Superlink signal line (A or B) Short-circuit in the Superlink signal line (between A and B) Faulty Superlink signal circuit 	
Two flashes	Flashing	<ul style="list-style-type: none"> Faulty address setting for the SL E board (Set up the address for previous SL E board : more than 48 new SL E board : more than 128) 	
Three flashes	Flashing	<ul style="list-style-type: none"> SL E board parent not set up when used without a remote control Faulty remote control communication circuit 	E1
Four flashes	Flashing	<ul style="list-style-type: none"> Address overlapping for the SL E board and the Superlink network connected indoor unit 	E2
Off	Flashing	<ul style="list-style-type: none"> Number of connected devices exceeds the specification for the multiple indoor unit control 	E10

15. TECHNICAL INFORMATION

Model SRK63ZR-WF

Information to identify the model(s) to which the information relates to:		If function includes heating: Indicate the heating season the information relates to. Indicated values should relate to one heating season at a time. Include at least the heating season 'Average'.	
Indoor unit model name	SRK63ZR-WF		
Outdoor unit model name	SRC63ZR-W		
Function(indicate if present)		Average(mandatory)	
cooling	Yes	Yes	
heating	Yes	Warmer(if designated)	
		Yes	
		Colder(if designated)	
		No	
Item	symbol	value	unit
Design load			
cooling	Pdesignc	6.30	kW
heating / Average	Pdesignh	5.40	kW
heating / Warmer	Pdesignh	6.60	kW
heating / Colder	Pdesignh	-	kW
Item	symbol	value	class
Seasonal efficiency and energy efficiency class			
cooling	SEER	8.10	A++
heating / Average	SCOP/A	4.70	A++
heating / Warmer	SCOP/W	6.00	A+++
heating / Colder	SCOP/C	-	-
Declared capacity at outdoor temperature Tdesignh		Back up heating capacity at outdoor temperature Tdesignh	
heating / Average (-10°C)	Pdh	5.40	kW
heating / Warmer (2°C)	Pdh	6.60	kW
heating / Colder (-22°C)	Pdh	-	kW
heating / Average (-10°C)	elbu	0	kW
heating / Warmer (2°C)	elbu	0	kW
heating / Colder (-22°C)	elbu	-	kW
Declared capacity for cooling, at indoor temperature 27(19)°C and outdoor temperature Tj		Declared energy efficiency ratio, at indoor temperature 27(19)°C and outdoor temperature Tj	
Tj=35°C	Pdc	6.30	kW
Tj=30°C	Pdc	4.64	kW
Tj=25°C	Pdc	2.98	kW
Tj=20°C	Pdc	1.60	kW
Tj=35°C	EERd	3.87	-
Tj=30°C	EERd	5.50	-
Tj=25°C	EERd	9.67	-
Tj=20°C	EERd	19.00	-
Declared capacity for heating / Average season, at indoor temperature 20°C and outdoor temperature Tj		Declared coefficient of performance / Average season, at indoor temperature 20°C and outdoor temperature Tj	
Tj=-7°C	Pdh	4.78	kW
Tj=2°C	Pdh	2.80	kW
Tj=7°C	Pdh	1.87	kW
Tj=12°C	Pdh	0.94	kW
Tj=bivalent temperature	Pdh	5.40	kW
Tj=operating limit	Pdh	5.40	kW
Tj=-7°C	COPd	2.93	-
Tj=2°C	COPd	4.73	-
Tj=7°C	COPd	6.00	-
Tj=12°C	COPd	6.50	-
Tj=bivalent temperature	COPd	2.60	-
Tj=operating limit	COPd	2.60	-
Declared capacity for heating / Warmer season, at indoor temperature 20°C and outdoor temperature Tj		Declared coefficient of performance / Warmer season, at indoor temperature 20°C and outdoor temperature Tj	
Tj=2°C	Pdh	6.60	kW
Tj=7°C	Pdh	4.25	kW
Tj=12°C	Pdh	1.89	kW
Tj=bivalent temperature	Pdh	6.60	kW
Tj=operating limit	Pdh	6.60	kW
Tj=2°C	COPd	2.90	-
Tj=7°C	COPd	5.54	-
Tj=12°C	COPd	7.31	-
Tj=bivalent temperature	COPd	2.90	-
Tj=operating limit	COPd	2.90	-
Declared capacity for heating / Colder season, at indoor temperature 20°C and outdoor temperature Tj		Declared coefficient of performance / Colder season, at indoor temperature 20°C and outdoor temperature Tj	
Tj=-7°C	Pdh	-	kW
Tj=2°C	Pdh	-	kW
Tj=7°C	Pdh	-	kW
Tj=12°C	Pdh	-	kW
Tj=bivalent temperature	Pdh	-	kW
Tj=operating limit	Pdh	-	kW
Tj=-15°C	Pdh	-	kW
Tj=-7°C	COPd	-	-
Tj=2°C	COPd	-	-
Tj=7°C	COPd	-	-
Tj=12°C	COPd	-	-
Tj=bivalent temperature	COPd	-	-
Tj=operating limit	COPd	-	-
Tj=-15°C	COPd	-	-
Bivalent temperature		Operating limit temperature	
heating / Average	Tbiv	-10	°C
heating / Warmer	Tbiv	2	°C
heating / Colder	Tbiv	-	°C
heating / Average	Tol	-10	°C
heating / Warmer	Tol	2	°C
heating / Colder	Tol	-	°C
Cycling interval capacity		Cycling interval efficiency	
for cooling	Pcycc	-	kW
for heating	Pcyh	-	kW
for cooling	EERcyc	-	-
for heating	COPcyc	-	-
Degradation coefficient		Degradation coefficient	
cooling	Cdc	0.25	-
heating	Cdh	0.25	-
Electric power input in power modes other than 'active mode'		Annual electricity consumption	
off mode	Poff	5	W
standby mode	Psb	5	W
thermostat-off mode	Pto(cooling)	16	W
	Pto(heating)	17	W
crankcase heater mode	Pck	0	W
cooling	Qce	273	kWh/a
heating / Average	Qhe	1608	kWh/a
heating / Warmer	Qhe	1539	kWh/a
heating / colder	Qhe	-	kWh/a
Capacity control(indicate one of three options)		Other items	
fixed		Lwa	56 dB(A)
staged	No	Lwa	64 dB(A)
variable	No	GWP	675 kgCO2eq.
	Yes	-	1230 m³/h
		-	2490 m³/h
Contact details for obtaining more information	Name and address of the manufacturer or of its authorised representative. (EU) MHI/AE SERVICES B.V. Herikerbergweg 238, Luna ArenA, 1101 CM Amsterdam, Netherlands. P.O.Box 23393 1100 DW Amsterdam, Netherlands (UK) Mitsubishi Heavy Industries Air-Conditioning Europe, Ltd 5 The Square, Stockley Park, Uxbridge, Middlesex, UB11 1ET, United Kingdom		

RWA000Z267 

Model SRK71ZR-WF

Information to identify the model(s) to which the information relates to:				If function includes heating: Indicate the heating season the information relates to. Indicated values should relate to one heating season at a time. Include at least the heating season 'Average'.					
Indoor unit model name		SRK71ZR-WF		Average(mandatory)		Yes			
Outdoor unit model name		SRC71ZR-W		Warmer(if designated)		Yes			
Function(indicate if present)				Colder(if designated)				No	
cooling		Yes							
heating		Yes							
Item	symbol	value	unit	Item	symbol	value	class		
Design load				Seasonal efficiency and energy efficiency class					
cooling	Pdesignc	7.10	kW	cooling	SEER	7.40	A++		
heating / Average	Pdesignh	6.60	kW	heating / Average	SCOP/A	4.50	A+		
heating / Warmer	Pdesignh	8.30	kW	heating / Warmer	SCOP/W	5.70	A+++		
heating / Colder	Pdesignh	-	kW	heating / Colder	SCOP/C	-	-		
				unit					
Declared capacity at outdoor temperature Tdesignh				Back up heating capacity at outdoor temperature Tdesignh					
heating / Average (-10°C)	Pdh	6.60	kW	heating / Average (-10°C)	elbu	0	kW		
heating / Warmer (2°C)	Pdh	8.30	kW	heating / Warmer (2°C)	elbu	0	kW		
heating / Colder (-22°C)	Pdh	-	kW	heating / Colder (-22°C)	elbu	-	kW		
Declared capacity for cooling, at indoor temperature 27(19)°C and outdoor temperature Tj				Declared energy efficiency ratio, at indoor temperature 27(19)°C and outdoor temperature Tj					
Tj=35°C	Pdc	7.10	kW	Tj=35°C	EERd	3.68	-		
Tj=30°C	Pdc	5.23	kW	Tj=30°C	EERd	5.45	-		
Tj=25°C	Pdc	3.36	kW	Tj=25°C	EERd	9.40	-		
Tj=20°C	Pdc	3.20	kW	Tj=20°C	EERd	13.40	-		
Declared capacity for heating / Average season, at indoor temperature 20°C and outdoor temperature Tj				Declared coefficient of performance / Average season, at indoor temperature 20°C and outdoor temperature Tj					
Tj=-7°C	Pdh	5.80	kW	Tj=-7°C	COPd	2.75	-		
Tj=2°C	Pdh	3.55	kW	Tj=2°C	COPd	4.50	-		
Tj=7°C	Pdh	2.28	kW	Tj=7°C	COPd	5.90	-		
Tj=12°C	Pdh	2.65	kW	Tj=12°C	COPd	7.30	-		
Tj=bivalent temperature	Pdh	6.60	kW	Tj=bivalent temperature	COPd	2.20	-		
Tj=operating limit	Pdh	6.60	kW	Tj=operating limit	COPd	2.20	-		
Declared capacity for heating / Warmer season, at indoor temperature 20°C and outdoor temperature Tj				Declared coefficient of performance / Warmer season, at indoor temperature 20°C and outdoor temperature Tj					
Tj=2°C	Pdh	8.30	kW	Tj=2°C	COPd	2.62	-		
Tj=7°C	Pdh	5.34	kW	Tj=7°C	COPd	5.15	-		
Tj=12°C	Pdh	2.65	kW	Tj=12°C	COPd	7.30	-		
Tj=bivalent temperature	Pdh	8.30	kW	Tj=bivalent temperature	COPd	2.62	-		
Tj=operating limit	Pdh	8.30	kW	Tj=operating limit	COPd	2.62	-		
Declared capacity for heating / Colder season, at indoor temperature 20°C and outdoor temperature Tj				Declared coefficient of performance / Colder season, at indoor temperature 20°C and outdoor temperature Tj					
Tj=-7°C	Pdh	-	kW	Tj=-7°C	COPd	-	-		
Tj=2°C	Pdh	-	kW	Tj=2°C	COPd	-	-		
Tj=7°C	Pdh	-	kW	Tj=7°C	COPd	-	-		
Tj=12°C	Pdh	-	kW	Tj=12°C	COPd	-	-		
Tj=bivalent temperature	Pdh	-	kW	Tj=bivalent temperature	COPd	-	-		
Tj=operating limit	Pdh	-	kW	Tj=operating limit	COPd	-	-		
Tj=-15°C	Pdh	-	kW	Tj=-15°C	COPd	-	-		
Bivalent temperature				Operating limit temperature					
heating / Average	Tbiv	-10	°C	heating / Average	Tol	-10	°C		
heating / Warmer	Tbiv	2	°C	heating / Warmer	Tol	2	°C		
heating / Colder	Tbiv	-	°C	heating / Colder	Tol	-	°C		
Cycling interval capacity				Cycling interval efficiency					
for cooling	Pcycc	-	kW	for cooling	EERcyc	-	-		
for heating	Pcych	-	kW	for heating	COPcyc	-	-		
Degradation coefficient				Degradation coefficient					
cooling	Cdc	0.25	-	heating	Cdh	0.25	-		
Electric power input in power modes other than 'active mode'				Annual electricity consumption					
off mode	Poff	5	W	cooling	Qce	337	kWh/a		
standby mode	Psb	5	W	heating / Average	Qhe	2055	kWh/a		
thermostat-off mode	Pto(cooling)	16	W	heating / Warmer	Qhe	2040	kWh/a		
crankcase heater mode	Pto(heating)	17	W	heating / colder	Qhe	-	kWh/a		
	Pck	0	W						
Capacity control(indicate one of three options)				Other items					
fixed		No		Sound power level(indoor)	Lwa	57	dB(A)		
staged		No		Sound power level(outdoor)	Lwa	63	dB(A)		
variable		Yes		Global warming potential	GWP	675	kgCO2eq.		
				Rated air flow(indoor)	-	1230	m³/h		
				Rated air flow(outdoor)	-	3300	m³/h		
Contact details for obtaining more information	Name and address of the manufacturer or of its authorised representative.								
	(EU) MHIAE SERVICES B.V. Herikerbergweg 238, Luna Arena, 1101 CM Amsterdam, Netherlands. P.O.Box 23393 1100 DW Amsterdam, Netherlands								
	(UK) Mitsubishi Heavy Industries Air-Conditioning Europe, Ltd 5 The Square, Stockley Park, Uxbridge, Middlesex, UB11 1ET, United Kingdom								

Model SRK80ZR-WF

Information to identify the model(s) to which the information relates to:				If function includes heating: Indicate the heating season the information relates to. Indicated values should relate to one heating season at a time. Include at least the heating season 'Average'.							
Indoor unit model name		SRK80ZR-WF		Average(mandatory)		Yes					
Outdoor unit model name		SRC80ZR-W		Warmer(if designated)		Yes					
Function(indicate if present)				Colder(if designated)				No			
cooling		Yes									
heating		Yes									
Item				Item							
symbol		value		symbol		value		class			
Design load				Seasonal efficiency and energy efficiency class							
cooling		Pdesignc		cooling		SEER		7.00		A++	
heating / Average		Pdesignh		heating / Average		SCOP/A		4.40		A+	
heating / Warmer		Pdesignh		heating / Warmer		SCOP/W		5.70		A+++	
heating / Colder		Pdesignh		heating / Colder		SCOP/C		-		-	
				unit							
Declared capacity at outdoor temperature Tdesignh				Back up heating capacity at outdoor temperature Tdesignh							
heating / Average (-10°C)		Pdh		heating / Average (-10°C)		elbu		0		kW	
heating / Warmer (2°C)		Pdh		heating / Warmer (2°C)		elbu		0		kW	
heating / Colder (-22°C)		Pdh		heating / Colder (-22°C)		elbu		-		kW	
Declared capacity for cooling, at indoor temperature 27(19)°C and outdoor temperature Tj				Declared energy efficiency ratio, at indoor temperature 27(19)°C and outdoor temperature Tj							
Tj=35°C		Pdc		Tj=35°C		EERd		3.83		-	
Tj=30°C		Pdc		Tj=30°C		EERd		5.40		-	
Tj=25°C		Pdc		Tj=25°C		EERd		8.20		-	
Tj=20°C		Pdc		Tj=20°C		EERd		12.40		-	
Declared capacity for heating / Average season, at indoor temperature 20°C and outdoor temperature Tj				Declared coefficient of performance / Average season, at indoor temperature 20°C and outdoor temperature Tj							
Tj=-7°C		Pdh		Tj=-7°C		COPd		2.70		-	
Tj=2°C		Pdh		Tj=2°C		COPd		4.40		-	
Tj=7°C		Pdh		Tj=7°C		COPd		5.70		-	
Tj=12°C		Pdh		Tj=12°C		COPd		7.20		-	
Tj=bivalent temperature		Pdh		Tj=bivalent temperature		COPd		2.30		-	
Tj=operating limit		Pdh		Tj=operating limit		COPd		2.30		-	
Declared capacity for heating / Warmer season, at indoor temperature 20°C and outdoor temperature Tj				Declared coefficient of performance / Warmer season, at indoor temperature 20°C and outdoor temperature Tj							
Tj=2°C		Pdh		Tj=2°C		COPd		2.63		-	
Tj=7°C		Pdh		Tj=7°C		COPd		5.21		-	
Tj=12°C		Pdh		Tj=12°C		COPd		7.19		-	
Tj=bivalent temperature		Pdh		Tj=bivalent temperature		COPd		2.63		-	
Tj=operating limit		Pdh		Tj=operating limit		COPd		2.63		-	
Declared capacity for heating / Colder season, at indoor temperature 20°C and outdoor temperature Tj				Declared coefficient of performance / Colder season, at indoor temperature 20°C and outdoor temperature Tj							
Tj=-7°C		Pdh		Tj=-7°C		COPd		-		-	
Tj=2°C		Pdh		Tj=2°C		COPd		-		-	
Tj=7°C		Pdh		Tj=7°C		COPd		-		-	
Tj=12°C		Pdh		Tj=12°C		COPd		-		-	
Tj=bivalent temperature		Pdh		Tj=bivalent temperature		COPd		-		-	
Tj=operating limit		Pdh		Tj=operating limit		COPd		-		-	
Tj=-15°C		Pdh		Tj=-15°C		COPd		-		-	
Bivalent temperature				Operating limit temperature							
heating / Average		Tbiv		heating / Average		Tol		-10		°C	
heating / Warmer		Tbiv		heating / Warmer		Tol		2		°C	
heating / Colder		Tbiv		heating / Colder		Tol		-		°C	
Cycling interval capacity				Cycling interval efficiency							
for cooling		Pcycc		for cooling		EERcyc		-		-	
for heating		Pcyh		for heating		COPcyc		-		-	
Degradation coefficient				Degradation coefficient							
cooling		Cdc		heating		Cdh		0.25		-	
Electric power input in power modes other than 'active mode'				Annual electricity consumption							
off mode		Poff		cooling		Qce		401		kWh/a	
standby mode		Psb		heating / Average		Qhe		2259		kWh/a	
thermostat-off mode		Pto(cooling)		heating / Warmer		Qhe		2064		kWh/a	
crankcase heater mode		Pck		heating / colder		Qhe		-		kWh/a	
Capacity control(indicate one of three options)				Other items							
fixed		No		Sound power level(indoor)		Lwa		60		dB(A)	
staged		No		Sound power level(outdoor)		Lwa		67		dB(A)	
variable		Yes		Global warming potential		GWP		675		kgCO2eq.	
				Rated air flow(indoor)		-		1410		m³/h	
				Rated air flow(outdoor)		-		3780		m³/h	
Contact details for obtaining more information		Name and address of the manufacturer or of its authorised representative. (EU) MHI/AE SERVICES B.V. Herikerbergweg 238, Luna ArenA, 1101 CM Amsterdam, Netherlands. P.O.Box 23393 1100 DW Amsterdam, Netherlands (UK) Mitsubishi Heavy Industries Air-Conditioning Europe, Ltd 5 The Square, Stockley Park, Uxbridge, Middlesex, UB11 1ET, United Kingdom									

16. REFERENCE

(1) Outline

1-1) R32 as the alternative refrigerant for residential air-conditioners

As for the R410A refrigerant which we have been usually using for air-conditioners, in case of emissions into the atmosphere, we have been adopting the collection of refrigerant etc. in order to restrain the world from global warming.

Based on the 4th basic ecological plan, it is said that the amount of emission of the green house effect gases including the refrigerants which are being used for air-conditioners shall be reduced 80% by 2050, emissions of any kind of freon gases which have especially high global warming coefficient must be reduced much more.

Hence, it is required to converted the freon gases we are using for air-conditioners into the refrigerants which have lower global warming even though they are exhausted into the atmosphere.

On the other hand, the refrigerants for air-conditioners, lower effect of global warming, to secure its performance and high energy efficiency and safety are required, however, the refrigerants which satisfy all of them have not been announced yet.

For this purpose, we have been studying to make use of the refrigerant like R32 which has short life in the atmosphere, even though it has low global warming but low combustibility under the practical use for safety.

In 2004, IEC, international electrical safety for air-conditioners had been corrected, the regulation for safety of air-conditioners which use the combustible refrigerant have been issued, in 2010, the regulation adopting the degree which is considered to be damaged slightly because of difficulty of ignition due to its low combustion speed was issued in ANSI/ASHRAE34 regulations.

R32 has been approved as the refrigerant whose combustion speed degree is lower than 10cm/sec, the standardization for safety use is being proceeded so that R32 can be used more widely.

Although all the air-conditioners which use R32 have been designed with deep consideration in order to guarantee the safety, some cautions which are mandatory to be kept during its installation and services are shown as follows.

1-2) Chemical characteristics of R32

(i) Chemical characteristic

R32 is one of an ingredient which composes R410A, without toxicity, the chemically stable compound which consists of carbon and fluorine.

Life of R32 after diffusing in the atmosphere is very short, approximately 4.9 years, as a result, although the effect to global warming can be reduced, there are little combustible due to large ratio of hydrogen.

Table1 Chemical characteristic

	R32	R410A	R22
Chemical formation	CH ₂ F ₂	CH ₂ F ₂ /CHF ₂ CF ₃	CHCLF ₂
Composition (Mixture ratio weight%)	Single composition	R32/R125 (50/50 weight%)	Single composition
Boiling point	-51.7°C	-51.5°C	-40.8°C
Pressure at 50°C	3.14	3.07	1.94
Performance at 0/50°C	160	141	100
COP at Te/Tc/SC/SH=5/50/3/0°C	95	91	100
ODP(Ozone Depletion Potential)	0	0	0.055
GWP(Global Warming Potential)	675	2090	1810
Combustible characteristic	A2L	A1	A1
Toxicity	No	No	No

(ii) Pressure characteristic

As mentioned in table 2, vapor pressure of R32 is almost same as R410A under the identical refrigerant temperature, and it has 1.6 times of high performance comparison with R22.

Therefore, tool and apparatus which are intended to be used under high pressure condition shall be required same as R410A when service and installation are implemented.

Table2 Comparison of saturated vapour pressure (MPa)

Temperature [°C] \ Refrigerant	R32	R410A	R22
-20	0.30	0.30	0.14
0	0.71	0.70	0.40
20	1.37	1.35	0.81
40	2.38	2.32	1.43
60	3.84	3.73	2.33
65	4.29	4.17	2.60

1-3) Combustion characteristic

R32 is possible to combust slightly when following conditions (gas density and ignition energy) coincide.

a) Combustible gas density by mixture with the air

In the event that if the ignition source which is possible to ignite is within the gas density mentioned in table 3, R32 might combust.

However, the combustible gas density of R32 is higher than that of propane's one.

In addition, since the combustible gas density condition of R32 is possible to cause hypoxia (density of oxygen in the air is less than 18%), this is not the environment where people can work normally.

Table3 Combustible density range

	R32	Propane (Reference)
Density upper limit (vol%)	29.3	9.5
Density lower limit (vol%)	13.3	1.8

b) Energy necessary for ignition.

It is said that R32 is less combustible gas than propane, since the energy which enables to combust is big, for example, static electricity around the human body and electric lighter (few mJ) can not make it ignite.

Table4 Minimum energy to ignite

	R32	Propane
Minimum energy to ignite (mJ)	15	0.246

c) Combustion speed

Since the combustion speed of R32 is low, it never combusts explosively like propane.

Table5 Combustion speed

	R32	Propane
Combustion speed (cm/s)	6.7	38.7

Consequently, although the ignition never happens under the conditions of usual use and work, however, in the event of the ignition, please handle with great care because the fire might extend once the ignition occurs.

1-4) Refrigerant oil for R32

The refrigerant oil for R32 differs from the mineral oil which is being used for R22, since it is based on the synthetic oil for R32, please ensure to use the designated one.

(2) Cautions for safety

2-1) Transport of equipment containing flammable refrigerants

It is necessary to follow the applicable transport regulations during the transportation with respect to equipment containing flammable gas.

2-2) Marking of equipment using signs

All required signs are to be maintained and employers should ensure that employees receive suitable and sufficient instruction and training on the meaning of appropriate safety signs and the actions that need to be taken in connection with these signs.

2-3) Disposal of equipment using flammable refrigerants

National Regulations shall be followed.

2-4) Symbols

The following symbols and the information of the warning marking shall be provided as follows:



Symbol ISO 7010-W021 (2011)

Warning; Risk of fire / Flammable materials



Symbol ISO 7000-1641 (2004-01)

Operator's manual; operating instructions



Symbol ISO 7000-1659 (2004-01)

Service indicator; read technical manual

(a) WARNING

Do not use means to accelerate the defrosting process or to clean, other than those recommended by the manufacturer.

(b) The appliance shall be stored in a room without continuously operating ignition sources (for example: open flames, an operating gas appliance or an operating electric heater).

(c) Do not pierce or burn.

(d) Be aware that refrigerants may not contain an odour.

(3) General

3-1) The following information shall be specified in the manual where the information is needed for the function of the manual and as applicable to the appliance:

- (a) Information for spaces where refrigerant pipes are allowed, including statements
 - that the installation of pipe-work shall be kept to a minimum;
 - that pipe-work shall be protected from physical damage and, in the case of flammable refrigerants, shall not be installed in an unventilated space, if that space is smaller than A_{min} in Annex GG;
 - that compliance with national gas regulations shall be observed;
 - that mechanical connections made in accordance with 22.118 shall be accessible for maintenance purposes;
 - that, for appliances containing flammable refrigerants, the minimum floor area of the room shall be mentioned in the form of a table or a single figure without reference to a formula;
- (b) The maximum refrigerant charge amount (M);
- (c) The minimum rated airflow, if required by Annex GG;
- (d) Information for handling, installation, cleaning, servicing and disposal of refrigerant;
- (e) The minimum floor area of the room or the special requirements for the room in which an appliance containing flammable refrigerants can be located as defined in Annex GG, except where the refrigerant charge (M) is less than or equal to m_1 ($M \leq m_1$);
- (f) A warning to keep any required ventilation openings clear of obstruction;
- (g) A notice that servicing shall be performed only as recommended by the manufacturer.

3-2) Qualification of workers

Every working procedure that affects safety means shall only be carried out by competent persons according to Annex HH.

Examples for such working procedures are:

- Breaking into the refrigerating circuit;
- Opening of sealed components;
- Opening of ventilated enclosures.

► Checks to the area

Prior to beginning work on systems containing flammable refrigerants, safety checks are necessary to ensure that the risk of ignition is minimised.

For repair to the refrigerating system, following precautions shall be taken prior to conducting work on the system.

► Work procedure

Work shall be undertaken under a controlled procedure so as to minimise the risk of a flammable gas or vapour being present while the work is being performed.

► General work area

All maintenance staff and others working in the local area shall be instructed on the nature of work being carried out.

Work in confined spaces shall be avoided.

The area around the workspace shall be sectioned off.

Ensure that the conditions within the area have been made safe by control of flammable materials.

► Checking for presence of refrigerant

The area shall be checked with an appropriate refrigerant detector prior to and during work, to ensure the technician is aware of potentially toxic or flammable atmospheres.

Ensure that the leak detection equipment being used is suitable for use with all applicable refrigerants, i.e. non-sparking, adequately sealed or intrinsically safe.

► Presence of fire extinguisher

If any hot work is to be conducted on the refrigeration equipment or any associated parts, appropriate fire extinguishing equipment shall be available to hand. Have a dry powder or CO₂ fire extinguisher adjacent to the charging area.

► No ignition sources

No person carrying out work in relation to a refrigeration system which involves exposing any pipe work shall use any sources of ignition in such a manner that it may lead to the risk of fire or explosion.

All possible ignition sources, including cigarette smoking, should be kept sufficiently far away from the site of installation, repairing, removing and disposal, during which refrigerant can possibly be released to the surrounding space.

Prior to work taking place, the area around the equipment is to be surveyed to make sure that there are no flammable hazards or ignition risks.

“No Smoking” signs shall be displayed.

► Ventilated area

Ensure that the area is in the open or that it is adequately ventilated before breaking into the system or conducting any hot work.

A degree of ventilation shall continue during the period that the work is carried out.

The ventilation should safely disperse any released refrigerant and preferably expel it externally into the atmosphere.

► Checks to the refrigeration equipment

Where electrical components are being changed, they shall be fit for the purpose and to the correct specification. At all times the manufacturer’s maintenance and service guidelines shall be followed. If in doubt consult the manufacturer’s technical department for assistance.

The following checks shall be applied to installations using flammable refrigerants including R32:

- The charge size is in accordance with the room size within which the refrigerant containing parts are installed;
- The ventilation machinery and outlets are operating adequately and are not obstructed;
- If an indirect refrigerating circuit is being used, the secondary circuit shall be checked for the presence of refrigerant;
- Marking to the equipment continues to be visible and legible. Markings and signs that are illegible shall be corrected;
- Refrigeration pipe or components are installed in a position where they are unlikely to be exposed to any substance which may corrode refrigerant containing components, unless the components are constructed of materials which are inherently resistant to being corroded or are suitably protected against being so corroded.

► Checks to electrical devices

Repair and maintenance to electrical components shall include initial safety checks and component inspection procedures.

If a fault exists that could compromise safety, then no electrical supply shall be connected to the circuit until it is satisfactorily dealt with.

If the fault cannot be corrected immediately but it is necessary to continue operation, an adequate temporary solution shall be used.

This shall be reported to the owner of the equipment so all parties are advised.

Initial safety checks shall include:

- that capacitors are discharged: this shall be done in a safe manner to avoid possibility of sparking;
- that no live electrical components and wiring are exposed while charging, recovering or purging the system;
- that there is continuity of earth bonding.

► Repairs to sealed components

During repairs to sealed components, all electrical supplies shall be disconnected from the equipment being worked upon prior to any removal of sealed covers, etc.

If it is absolutely necessary to have an electrical supply to equipment during servicing, then a permanently operating form of leak detection shall be located at the most critical point to warn of a potentially hazardous situation.

► Particular attention shall be paid to the following to ensure that by working on electrical components, the casing is not altered in such a way that the level of protection is affected.

This shall include damage to cables, excessive number of connections, terminals not made to original specification, damage to seals, incorrect fitting of glands, etc.

Ensure that the apparatus is mounted securely.

Ensure that seals or sealing materials have not degraded to the point that they no longer serve the purpose of preventing the ingress of flammable atmospheres.

Replacement parts shall be in accordance with the manufacturer's specifications.

► Repair to intrinsically safe components

- (1) Do not apply any permanent inductive or capacitance loads to the circuit without ensuring that this will not exceed the permissible voltage and current permitted for the equipment in use.

Intrinsically safe components are the only types that can be worked on while live in the presence of a flammable atmosphere. The test apparatus shall be at the correct rating.

Replace components only with parts specified by the manufacturer. Other parts may result in the ignition of refrigerant in the atmosphere from a leak.

► Cabling

- (1) Check that cabling will not be subject to wear, corrosion, excessive pressure, vibration, sharp edges or any other adverse environmental effects. The check shall also take into account the effects of aging or continual vibration from sources such as compressors or fans.

► Detection of flammable refrigerants

Under no circumstances shall potential sources of ignition be used in the searching for or detection of refrigerant leaks. A halide torch (or any other detector using a naked flame) shall not be used.

► Leak detection methods

The following leak detection methods are deemed acceptable for all refrigerant systems.

- (1) Electronic leak detectors may be used to detect refrigerant leaks but, in the case of flammable refrigerants, the sensitivity may not be adequate, or may need re-calibration. (Detection equipment shall be calibrated in a refrigerant-free area.)
Ensure that the detector is not a potential source of ignition and is suitable for the refrigerant used.
Leak detection equipment shall be set at a percentage of the LFL of the refrigerant and shall be calibrated to the refrigerant employed, and the appropriate percentage of gas (25 % maximum) is confirmed.
- (2) Leak detection fluids are suitable for use with most refrigerants but the use of detergents containing chlorine shall be avoided as the chlorine may react with the refrigerant and corrode the copper pipe-work.
- (3) If a leak is suspected, all naked flames shall be removed/extinguished.
- (4) If a leakage of refrigerant is found which requires brazing, all of the refrigerant shall be recovered from the system, or isolated (by means of shut off valves) in a part of the system remote from the leak.
For appliances containing flammable refrigerants, oxygen free nitrogen (OFN) shall then be purged through the system both before and during the brazing process.

► Removal and evacuation

When breaking into the refrigerant circuit to make repairs – or for any other purpose – conventional procedures shall be used. However, for flammable refrigerants it is important that best practice is followed since flammability is a consideration.

The following procedure shall be adhered to:

- remove refrigerant;
- purge the circuit with inert gas;
- evacuate;
- purge again with inert gas;
- open the circuit by cutting or brazing.

The refrigerant charge shall be recovered into the correct recovery cylinders.

For appliances containing flammable refrigerants, the system shall be “flushed” with OFN to render the unit safe.

This process may need to be repeated several times.

Compressed air or oxygen shall not be used for purging refrigerant systems.

For appliances containing flammable refrigerants, flushing shall be achieved by breaking the vacuum in the system with OFN and continuing to fill until the working pressure is achieved, then venting to atmosphere, and finally pulling down to a vacuum.

This process shall be repeated until no refrigerant is within the system.

When the final OFN charge is used, the system shall be vented down to atmospheric pressure to enable work to take place.

This operation is absolutely vital if brazing operations on the pipe-work are to take place.

Ensure that the outlet for the vacuum pump is not close to any ignition sources and that ventilation is available.

► Charging procedures

In addition to conventional charging procedures, the following requirements shall be followed.

- Ensure that contamination of different refrigerants does not occur when using charging equipment. Hoses or lines shall be as short as possible to minimise the amount of refrigerant contained in them.
- Cylinders shall be kept upright.
- Ensure that the refrigeration system is earthed prior to charging the system with refrigerant.
- Label the system when charging is complete (if not already).
- Extreme care shall be taken not to overfill the refrigeration system.

Prior to recharging the system, it shall be pressure-tested with the appropriate purging gas.

The system shall be leak-tested on completion of charging but prior to commissioning.

A follow up leak test shall be carried out prior to leaving the site.

► Decommissioning

Before carrying out this procedure, it is essential that the technician is completely familiar with the equipment and all its detail. It is recommended good practice that all refrigerants are recovered safely. Prior to the task being carried out, an oil and refrigerant sample shall be taken in case analysis is required prior to re-use of reclaimed refrigerant. It is essential that electrical power is available before the task is commenced.

- a) Become familiar with the equipment and its operation.
- b) Isolate system electrically.
- c) Before attempting the procedure ensure that:
 - mechanical handling equipment is available, if required, for handling refrigerant cylinders;
 - all personal protective equipment is available and being used correctly;
 - the recovery process is supervised at all times by a competent person;
 - recovery equipment and cylinders conform to the appropriate standards.
- d) Pump down refrigerant system, if possible.
- e) If a vacuum is not possible, make a manifold so that refrigerant can be removed from various parts of the system.
- f) Make sure that cylinder is situated on the scales before recovery takes place.
- g) Start the recovery machine and operate in accordance with manufacturer's instructions.
- h) Do not overfill cylinders. (No more than 80 % volume liquid charge).
- i) Do not exceed the maximum working pressure of the cylinder, even temporarily.
- j) When the cylinders have been filled correctly and the process completed, make sure that the cylinders and the equipment are removed from site promptly and all isolation valves on the equipment are closed off.
- k) Recovered refrigerant shall not be charged into another refrigeration system unless it has been cleaned and checked.

► Labelling

Equipment shall be labelled stating that it has been de-commissioned and emptied of refrigerant.

The label shall be dated and signed.

For appliances containing flammable refrigerants, ensure that there are labels on the equipment stating the equipment contains flammable refrigerant.

► Recovery

When removing refrigerant from a system, either for servicing or decommissioning, it is recommended good practice that all refrigerants are removed safely.

When transferring refrigerant into cylinders, ensure that only appropriate refrigerant recovery cylinders are employed.

Ensure that the correct number of cylinders for holding the total system charge are available.

All cylinders to be used are designated for the recovered refrigerant and labelled for that refrigerant (i.e. special cylinders for the recovery of refrigerant).

Cylinders shall be complete with pressure relief valve and associated shut-off valves in good working order.

Empty recovery cylinders are evacuated and, if possible, cooled before recovery occurs.

The recovery equipment shall be in good working order with a set of instructions concerning the equipment that is at hand and shall be suitable for the recovery of all appropriate refrigerants including, when applicable, flammable refrigerants.

In addition, a set of calibrated weighing scales shall be available and in good working order.

Hoses shall be complete with leak-free disconnect couplings and in good condition.

Before using the recovery machine, check that it is in satisfactory working order, has been properly maintained and that any associated electrical components are sealed to prevent ignition in the event of a refrigerant release.

Consult manufacturer if in doubt.

The recovered refrigerant shall be returned to the refrigerant supplier in the correct recovery cylinder, and the relevant Waste Transfer Note arranged.

Do not mix refrigerants in recovery units and especially not in cylinders.

If compressors or compressor oils are to be removed, ensure that they have been evacuated to an acceptable level to make certain that flammable refrigerant does not remain within the lubricant.

The evacuation process shall be carried out prior to returning the compressor to the suppliers.

Only electric heating to the compressor body shall be employed to accelerate this process. When oil is drained from a system, it shall be carried out safely.